

**20V PNP LOW SATURATION TRANSISTOR IN SOT23**

**Features**

- $BV_{CEO} > -20V$
- $I_C = -2A$  Continuous Collector Current
- $I_{CM} = -4A$  Peak Pulse Current
- Low Saturation Voltage  $V_{CE(sat)} < -120mV @ -1A$
- $R_{CE(SAT)} = 40m\Omega$  for a low equivalent on-resistance
- Complimentary NPN Type : DSS20201L
- **Totally Lead-Free & Fully RoHS compliant (Notes 1 & 2)**
- **Halogen and Antimony Free. "Green" Device (Note 3)**
- **Qualified to AEC-Q101 Standards for High Reliability**

**Mechanical Data**

- Case: SOT23
- Case Material: molded plastic, "Green" molding compound  
UL Flammability Classification Rating 94V-0
- Moisture Sensitivity: Level 1 per J-STD-020
- Terminals: Finish – Matte Tin Plated Leads, Solderable per MIL-STD-202, Method 208 ③
- Weight: 0.008 grams (approximate)



Top View

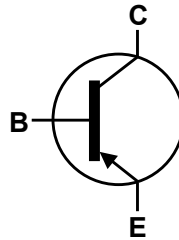

Device Symbol

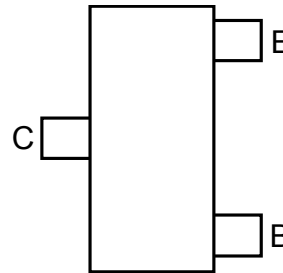

Top View  
Pin-Out

**Ordering Information** (Note 4)

Product	Marking	Reel size (inches)	Tape width (mm)	Quantity per reel
DSS20200L-7	ZP1	7	8	3,000
DSS20200L-13	ZP1	13	8	10,000

- Notes:
1. No purposely added lead. Fully EU Directive 2002/95/EC (RoHS) & 2011/65/EU (RoHS 2) compliant.
  2. See [http://www.diodes.com/quality/lead\\_free.html](http://www.diodes.com/quality/lead_free.html) for more information about Diodes Incorporated's definitions of Halogen- and Antimony-free, "Green" and Lead-free.
  3. Halogen and Antimony free "Green" products are defined as those which contain <900ppm bromine, <900ppm chlorine (<1500ppm total Br + Cl) and <1000ppm antimony compounds.
  4. For packaging details, go to our website at <http://www.diodes.com/products/packages.html>.

**Marking Information**

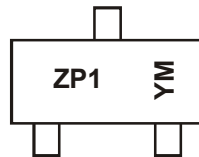

ZP1 = Product Type Marking Code  
YM = Date Code Marking  
Y = Year (ex: A = 2013)  
M = Month (ex: 9 = September)

Date Code Key

Year	2008	2009	2010	2011	2012	2013	2014	2015
Code	V	W	X	Y	Z	A	B	C

Month	Jan	Feb	Mar	Apr	May	Jun	Jul	Aug	Sep	Oct	Nov	Dec
Code	1	2	3	4	5	6	7	8	9	O	N	D

**Absolute Maximum Ratings** (@ $T_A = +25^\circ\text{C}$ , unless otherwise specified.)

Characteristic	Symbol	Value	Unit
Collector-Base Voltage	$V_{CBO}$	-20	V
Collector-Emitter Voltage	$V_{CEO}$	-20	V
Emitter-Base Voltage	$V_{EBO}$	-7	V
Peak Pulse Collector Current	$I_{CM}$	-4	A
Continuous Collector Current	$I_C$	-2	A

**Thermal Characteristics** (@ $T_A = +25^\circ\text{C}$ , unless otherwise specified.)

Characteristic	Symbol	Value	Unit
Power Dissipation	$P_D$	(Note 5) 600	mW
		(Note 6) 1.2	
Thermal Resistance, Junction to Ambient Air	$R_{\theta JA}$	(Note 5) 209	$^\circ\text{C}/\text{W}$
		(Note 6) 104	
Thermal Resistance, Junction to Leads	$R_{\theta JL}$	(Note 7) 75	
Operating and Storage Temperature Range	$T_J, T_{STG}$	-55 to +150	$^\circ\text{C}$

**ESD Ratings** (Note 8)

Characteristic	Symbol	Value	Unit	JEDEC Class
Electrostatic Discharge - Human Body Model	ESD HBM	4,000	V	3A
Electrostatic Discharge - Machine Model	ESD MM	400	V	C

- Notes:
5. For a device mounted on minimum recommended pad layout with 1oz copper that is on a single-sided 1.6mm FR4 PCB; device is measured under still air conditions whilst operating in a steady-state.
  6. Same as note (5), except mounted on 25mm x 25mm 1oz copper.
  7. Thermal resistance from junction to solder-point (at the end of collector lead).
  8. Refer to JEDEC specification JESD22-A114 and JESD22-A115.

**Thermal Characteristics and Derating information**

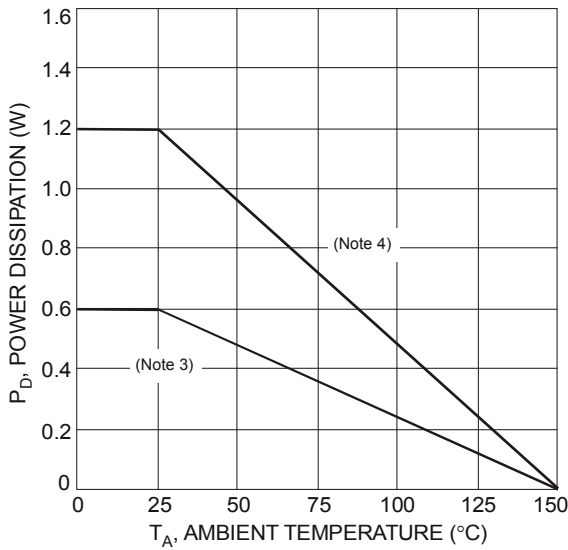

Figure 1 Power Dissipation vs. Ambient Temperature

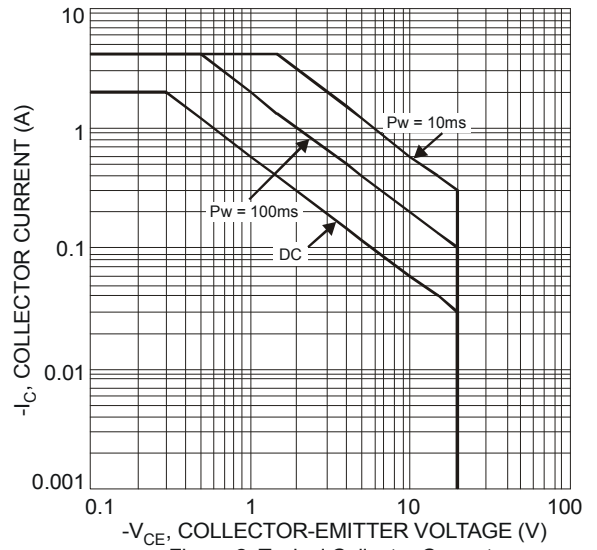

Figure 2 Typical Collector Current vs. Collector-Emitter Voltage

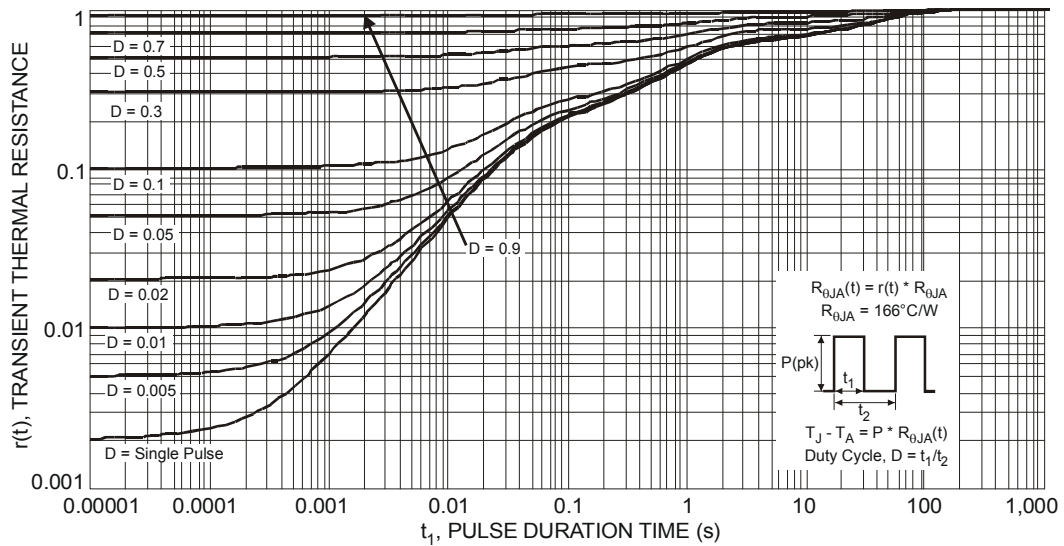

Figure 3 Transient Thermal Response

**Electrical Characteristics** (@ $T_A = +25^\circ\text{C}$ , unless otherwise specified.)

Characteristic	Symbol	Min	Typ	Max	Unit	Test Conditions
<b>OFF CHARACTERISTICS</b>						
Collector-Base Breakdown Voltage	$BV_{CBO}$	-20	—	—	V	$I_C = -100\mu\text{A}$
Collector-Emitter Breakdown Voltage (Note 9)	$BV_{CEO}$	-20	—	—	V	$I_C = -10\text{mA}$
Emitter-Base Breakdown Voltage	$BV_{EBO}$	-7	—	—	V	$I_E = -100\mu\text{A}$
Collector-Base Cutoff Current	$I_{CBO}$	—	—	-100	nA	$V_{CB} = -20\text{V}, I_E = 0$
Emitter-Base Cutoff Current	$I_{EBO}$	—	—	-100	nA	$V_{EB} = -7\text{V}, I_C = 0$
<b>ON CHARACTERISTICS (Note 9)</b>						
DC Current Gain	$h_{FE}$	250	—	—	—	$V_{CE} = -2\text{V}, I_C = -10\text{mA}$
		250	—	—		$V_{CE} = -2\text{V}, I_C = -500\text{mA}$
		180	—	—		$V_{CE} = -2\text{V}, I_C = -1\text{A}$
		150	—	—		$V_{CE} = -2\text{V}, I_C = -2\text{A}$
Collector-Emitter Saturation Voltage	$V_{CE(SAT)}$	—	—	-13	mV	$I_C = -0.1\text{A}, I_B = -10\text{mA}$
		—	-50	-90		$I_C = -1\text{A}, I_B = -100\text{mA}$
		—	-100	-120		$I_C = -1\text{A}, I_B = -10\text{mA}$
		—	-80	-180		$I_C = -2\text{A}, I_B = -200\text{mA}$
Equivalent On-Resistance	$R_{CE(SAT)}$	—	40	90	$\text{m}\Omega$	$I_C = -2\text{A}, I_B = -200\text{mA}$
Base-Emitter Saturation Voltage	$V_{BE(SAT)}$	—	—	-0.9	V	$I_C = -1\text{A}, I_B = -10\text{mA}$
Base-Emitter Turn-on Voltage	$V_{BE(ON)}$	—	—	-0.9	V	$V_{CE} = -2\text{V}, I_C = -1\text{A}$
<b>SMALL SIGNAL CHARACTERISTICS</b>						
Transition Frequency	$f_T$	100	—	—	MHz	$V_{CE} = -5\text{V}, I_C = -100\text{mA}, f = 100\text{MHz}$
Output Capacitance	$C_{obo}$	—	—	100	pF	$V_{CB} = -3\text{V}, f = 1\text{MHz}$
Input Capacitance	$C_{ibo}$	—	—	330	pF	$V_{EB} = -0.5\text{V}, f = 1\text{MHz}$
<b>SWITCHING CHARACTERISTICS</b>						
Turn-On Time	$t_{on}$	—	—	180	ns	$V_{CC} = -15\text{V}, I_C = -750\text{mA}, I_{B1} = -15\text{mA}$
Delay Time	$t_d$	—	—	60	ns	
Rise Time	$t_r$	—	—	120	ns	
Turn-Off Time	$t_{off}$	—	—	430	ns	$V_{CC} = -15\text{V}, I_C = -750\text{mA}, I_{B1} = I_{B2} = -15\text{mA}$
Storage Time	$t_s$	—	—	300	ns	
Fall Time	$t_f$	—	—	130	ns	

Note: 9. Measured under pulsed conditions. Pulse width  $\leq 300\mu\text{s}$ . Duty cycle  $\leq 2\%$

**Typical Electrical Characteristics** (@ $T_A = +25^\circ\text{C}$ , unless otherwise specified.)

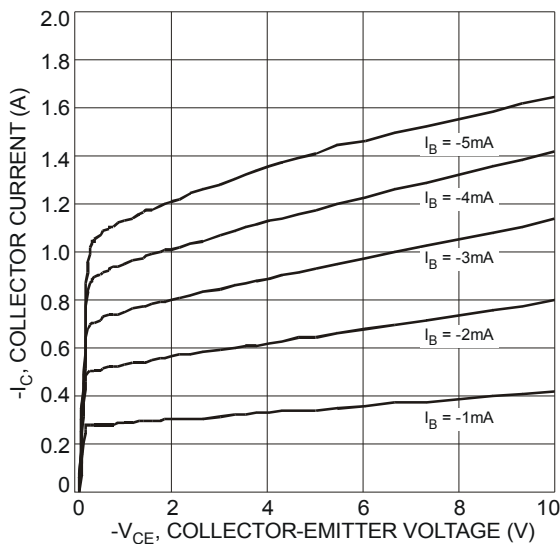

Figure 4 Typical Collector Current vs. Collector-Emitter Voltage

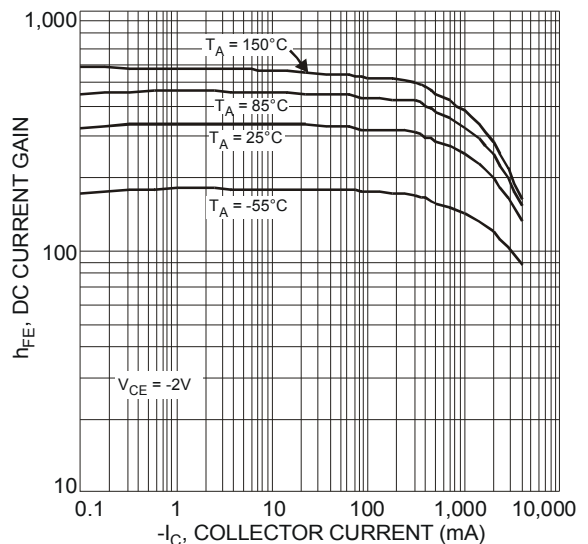

Figure 5 Typical DC Current Gain vs. Collector Current

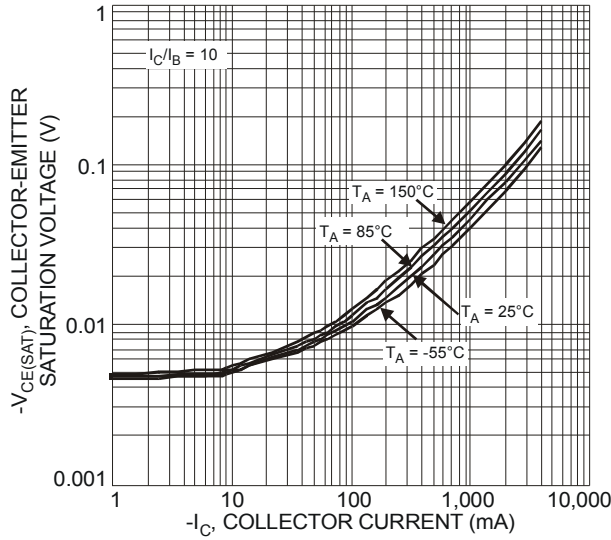

Figure 6 Typical Collector-Emitter Saturation Voltage vs. Collector Current

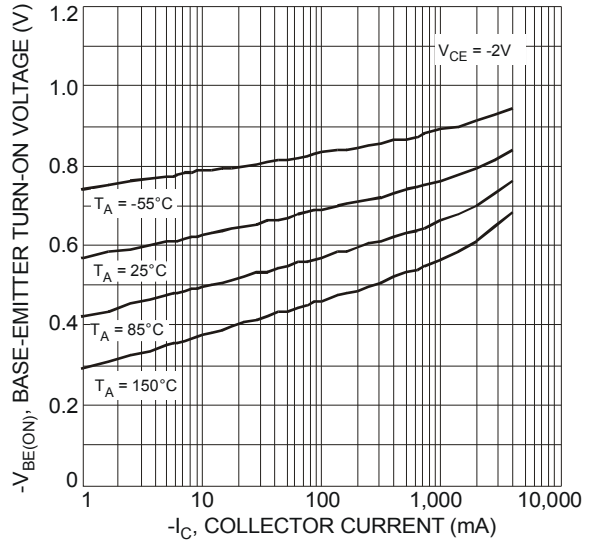

Figure 7 Typical Base-Emitter Turn-On Voltage vs. Collector Current

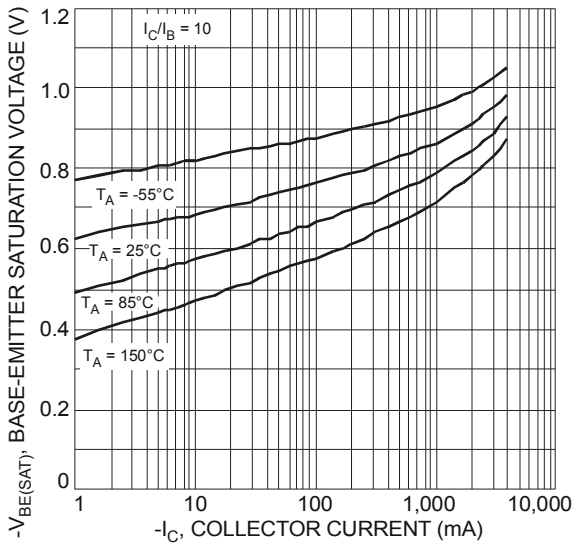

Figure 8 Typical Base-Emitter Saturation Voltage vs. Collector Current

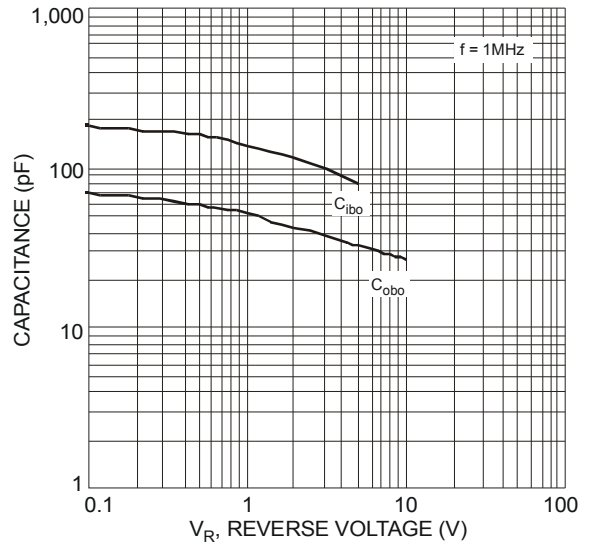

Figure 9 Typical Capacitance Characteristics

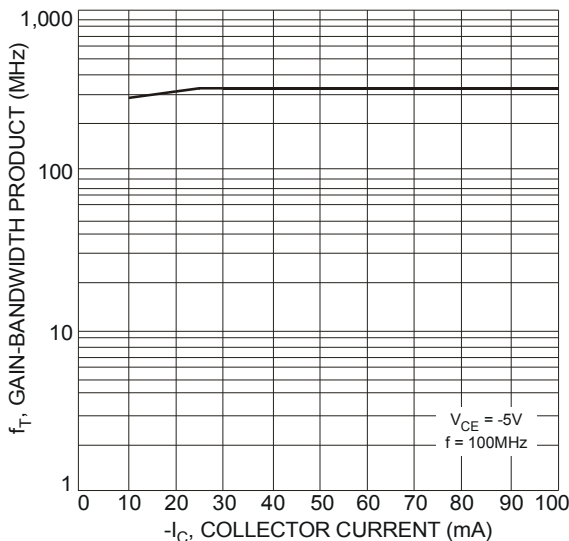
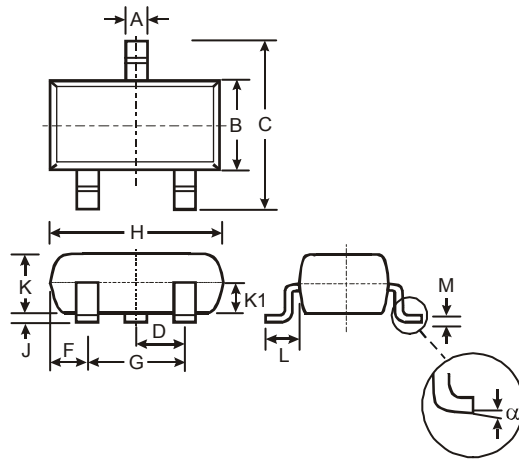

Figure 10 Typical Gain-Bandwidth Product vs. Collector Current

**Package Outline Dimensions**

Please see AP02002 at <http://www.diodes.com/datasheets/ap02002.pdf> for latest version.



SOT23			
Dim	Min	Max	Typ
A	0.37	0.51	0.40
B	1.20	1.40	1.30
C	2.30	2.50	2.40
D	0.89	1.03	0.915
F	0.45	0.60	0.535
G	1.78	2.05	1.83
H	2.80	3.00	2.90
J	0.013	0.10	0.05
K	0.903	1.10	1.00
K1	-	-	0.400
L	0.45	0.61	0.55
M	0.085	0.18	0.11
α	0°	8°	-
All Dimensions in mm			

**Suggested Pad Layout**

Please see AP02001 at <http://www.diodes.com/datasheets/ap02001.pdf> for the latest version.

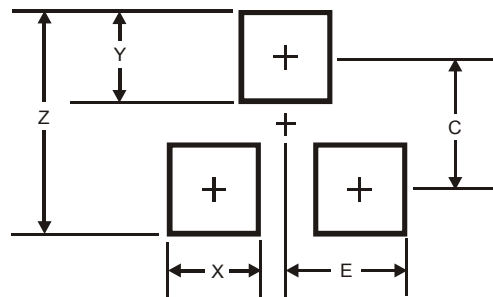

Dimensions	Value (in mm)
Z	2.9
X	0.8
Y	0.9
C	2.0
E	1.35

**IMPORTANT NOTICE**

DIODES INCORPORATED MAKES NO WARRANTY OF ANY KIND, EXPRESS OR IMPLIED, WITH REGARDS TO THIS DOCUMENT, INCLUDING, BUT NOT LIMITED TO, THE IMPLIED WARRANTIES OF MERCHANTABILITY AND FITNESS FOR A PARTICULAR PURPOSE (AND THEIR EQUIVALENTS UNDER THE LAWS OF ANY JURISDICTION).

Diodes Incorporated and its subsidiaries reserve the right to make modifications, enhancements, improvements, corrections or other changes without further notice to this document and any product described herein. Diodes Incorporated does not assume any liability arising out of the application or use of this document or any product described herein; neither does Diodes Incorporated convey any license under its patent or trademark rights, nor the rights of others. Any Customer or user of this document or products described herein in such applications shall assume all risks of such use and will agree to hold Diodes Incorporated and all the companies whose products are represented on Diodes Incorporated website, harmless against all damages.

Diodes Incorporated does not warrant or accept any liability whatsoever in respect of any products purchased through unauthorized sales channel. Should Customers purchase or use Diodes Incorporated products for any unintended or unauthorized application, Customers shall indemnify and hold Diodes Incorporated and its representatives harmless against all claims, damages, expenses, and attorney fees arising out of, directly or indirectly, any claim of personal injury or death associated with such unintended or unauthorized application.

Products described herein may be covered by one or more United States, international or foreign patents pending. Product names and markings noted herein may also be covered by one or more United States, international or foreign trademarks.

This document is written in English but may be translated into multiple languages for reference. Only the English version of this document is the final and determinative format released by Diodes Incorporated.

**LIFE SUPPORT**

Diodes Incorporated products are specifically not authorized for use as critical components in life support devices or systems without the express written approval of the Chief Executive Officer of Diodes Incorporated. As used herein:

A. Life support devices or systems are devices or systems which:

1. are intended to implant into the body, or
2. support or sustain life and whose failure to perform when properly used in accordance with instructions for use provided in the labeling can be reasonably expected to result in significant injury to the user.

B. A critical component is any component in a life support device or system whose failure to perform can be reasonably expected to cause the failure of the life support device or to affect its safety or effectiveness.

Customers represent that they have all necessary expertise in the safety and regulatory ramifications of their life support devices or systems, and acknowledge and agree that they are solely responsible for all legal, regulatory and safety-related requirements concerning their products and any use of Diodes Incorporated products in such safety-critical, life support devices or systems, notwithstanding any devices- or systems-related information or support that may be provided by Diodes Incorporated. Further, Customers must fully indemnify Diodes Incorporated and its representatives against any damages arising out of the use of Diodes Incorporated products in such safety-critical, life support devices or systems.

Copyright © 2013, Diodes Incorporated

**[www.diodes.com](http://www.diodes.com)**

# Mouser Electronics

Authorized Distributor

Click to View Pricing, Inventory, Delivery & Lifecycle Information:

[Diodes Incorporated:](#)

[DSS20200L-7](#)