

GaAs SPDT Switch DC - 3.0 GHz

Rev. V2

Features

- Low Insertion Loss: 0.3 dB @ 900 MHz
- Low Current Consumption: <15 μ A @ +2.5 V
- Positive or Negative 2.5 to 8 V Control
- Lead-Free SOT-363 Package
- 100% Matte Tin Plating over Copper
- Halogen-Free “Green” Mold Compound
- 260°C Reflow Compatible
- RoHS* Compliant Version of SW-437

Description

M/A-COM's MASWSS0166 is a GaAs monolithic switch in a lead-free SOT-363 surface mount plastic package. The MASWSS0166 is ideally suited for applications where very low power consumption, low insertion loss, very small size and low cost are required.

Typical applications are dual band systems that require switching between small signal components such as filter banks, single band LNA's and converters. The MASWSS0166 can be used in applications up to 0.25 Watts in systems such as cellular, PCS, DCS1800, GSM, CDMA, W-CDMA and other analog/digital wireless communications systems.

The MASWSS0166 is fabricated using a mature 0.5 micron GaAs PHEMT process. The process features full passivation for increased performance and reliability.

Absolute Maximum Ratings ^{1,2}

Parameter	Absolute Maximum
Input Power (0.5-3.0 GHz) 3 V Control 5 V Control	+30 dBm +33 dBm
Operating Voltage	+8.5 Volts
Operating Temperature	-40°C to +85°C
Storage Temperature	-65°C to +150°C

1. Exceeding any one or combination of these limits may cause permanent damage to this device.
2. M/A-COM does not recommend sustained operation near these survivability limits.

Functional Schematic:

Positive Control Voltage

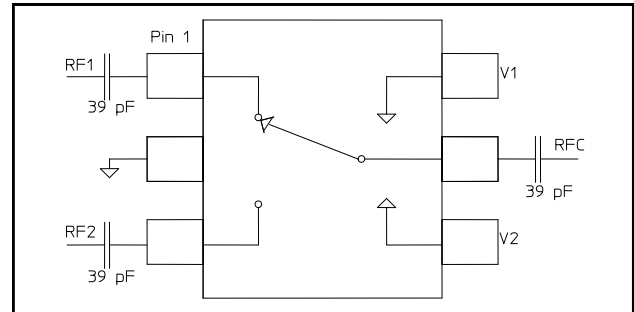

Functional Schematic:

Negative Control Voltage

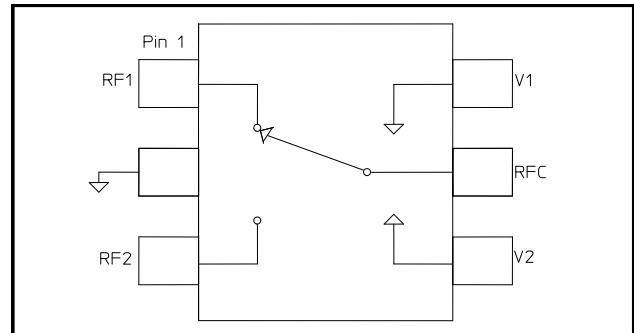

Pin Configuration

Pin No.	Function	Description
1	RF1	RF in/out
2	GND	RF Ground
3	RF2	RF in/out
4	V2	V Control 2
5	RFC	RF Common
6	V1	V Control 1

Ordering Information ³

Part Number	Package
MASWSS0166	Bulk Packaging
MASWSS0166TR-3000	3000 piece reel
MASWSS0166SMB	Sample Test Board

3. Reference Application Note M513 for reel size information.

* Restrictions on Hazardous Substances, European Union Directive 2002/95/EC.

GaAs SPDT Switch DC - 3.0 GHz

Rev. V2

Electrical Specifications: $T_A = 25^\circ\text{C}$, $V_c = 0\text{ V} / -2.5\text{ V}$, $Z_0 = 50\Omega$ ⁴

Parameter	Test Conditions	Units	Min.	Typ.	Max.
Insertion Loss	DC - 1 GHz	dB	—	0.3	0.4
	1 - 2 GHz	dB	—	0.4	0.5
	2 - 3 GHz	dB	—	0.55	0.7
Isolation	DC - 1 GHz	dB	19	21	—
	1 - 2 GHz	dB	13	15	—
	2 - 3 GHz	dB	10	12	—
VSWR	DC - 3 GHz	Ratio	—	1.2:1	—
P_{1dB}	500 MHz - 3 GHz, $ V_c = 2.7\text{ V}$	dBm	—	24	—
P_{1dB}	500 MHz - 3 GHz, $ V_c = 5\text{ V}$	dBm	—	27	—
Input IP_2	2-Tone, 900 MHz, 5 MHz spacing, $ V_c = 2.7\text{ V}$	dBm	—	81	—
Input IP_3	2-Tone 900 MHz, 5 MHz spacing, $ V_c = 2.7\text{ V}$	dBm	—	55	—
Trise, Tfall Ton, Toff Transients	10% to 90% RF, 90% to 10% RF	nS	—	10	—
	50% Control to 90% RF, 50% Control to 10% RF	nS	—	20	—
	In-Band	mV	—	10	—
Control Current	$ V_c = 2.5\text{ V}$	μA	—	4	15

4. For positive voltage control, external DC blocking capacitors are required on all RF ports.

Lead-Free SOT-363 Plastic Package[†]

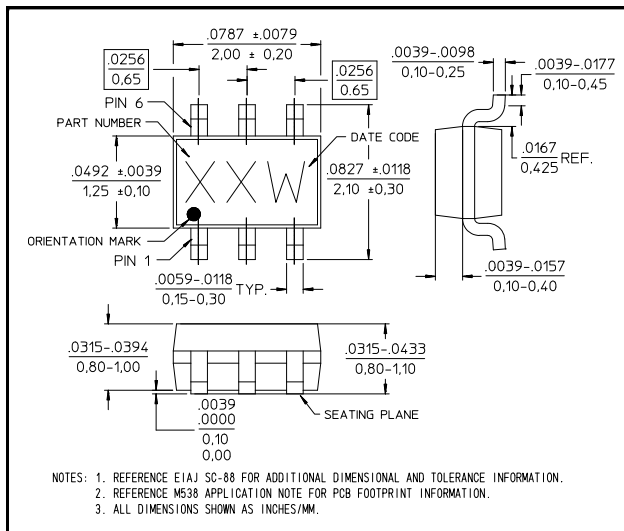

[†] Reference Application Note M538 for lead-free solder reflow recommendations.

Truth Table^{5,6}

V1	V2	RFC-RF1	RFC-RF2
0	1	On	Off
1	0	Off	On

- Differential voltage, $V(\text{state } 1) - V(\text{state } 0)$, must be +2.5 V minimum and must not exceed 8 V.
- 0 = -8 V to 0 V, 1 = -5.5 V to 8 V

Handling Procedures

Please observe the following precautions to avoid damage:

Static Sensitivity

Gallium Arsenide Integrated Circuits are sensitive to electrostatic discharge (ESD) and can be damaged by static electricity. Proper ESD control techniques should be used when handling these devices.

Typical Performance Curves

Insertion Loss (Negative Voltage Control)

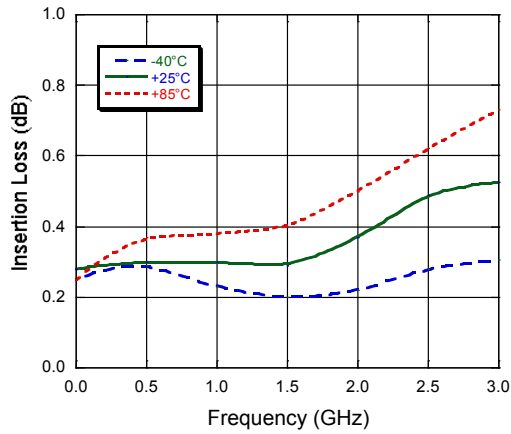

Insertion Loss (Positive Voltage Control)

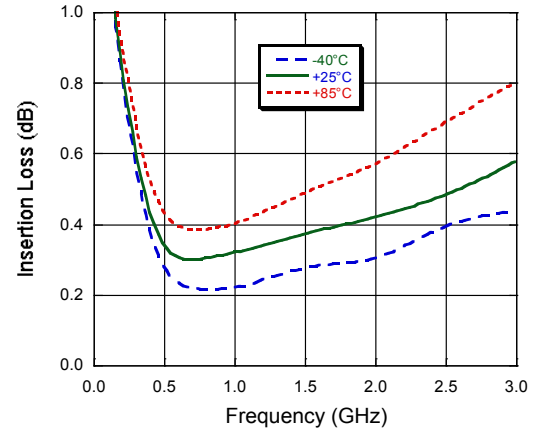

Isolation

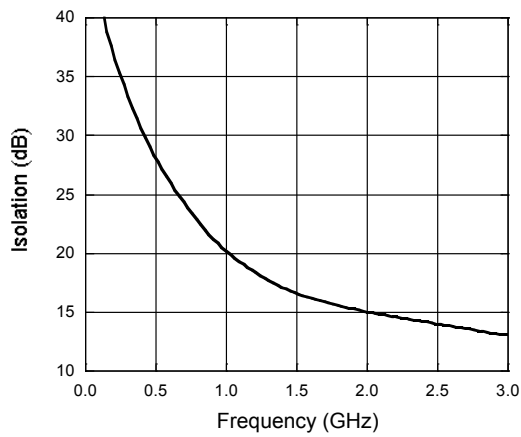

VSWR

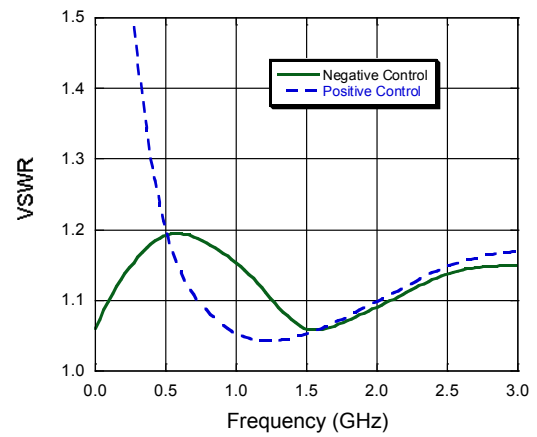

M/A-COM Technology Solutions Inc. All rights reserved.

Information in this document is provided in connection with M/A-COM Technology Solutions Inc ("MACOM") products. These materials are provided by MACOM as a service to its customers and may be used for informational purposes only. Except as provided in MACOM's Terms and Conditions of Sale for such products or in any separate agreement related to this document, MACOM assumes no liability whatsoever. MACOM assumes no responsibility for errors or omissions in these materials. MACOM may make changes to specifications and product descriptions at any time, without notice. MACOM makes no commitment to update the information and shall have no responsibility whatsoever for conflicts or incompatibilities arising from future changes to its specifications and product descriptions. No license, express or implied, by estoppel or otherwise, to any intellectual property rights is granted by this document.

THESE MATERIALS ARE PROVIDED "AS IS" WITHOUT WARRANTY OF ANY KIND, EITHER EXPRESS OR IMPLIED, RELATING TO SALE AND/OR USE OF MACOM PRODUCTS INCLUDING LIABILITY OR WARRANTIES RELATING TO FITNESS FOR A PARTICULAR PURPOSE, CONSEQUENTIAL OR INCIDENTAL DAMAGES, MERCHANTABILITY, OR INFRINGEMENT OF ANY PATENT, COPYRIGHT OR OTHER INTELLECTUAL PROPERTY RIGHT. MACOM FURTHER DOES NOT WARRANT THE ACCURACY OR COMPLETENESS OF THE INFORMATION, TEXT, GRAPHICS OR OTHER ITEMS CONTAINED WITHIN THESE MATERIALS. MACOM SHALL NOT BE LIABLE FOR ANY SPECIAL, INDIRECT, INCIDENTAL, OR CONSEQUENTIAL DAMAGES, INCLUDING WITHOUT LIMITATION, LOST REVENUES OR LOST PROFITS, WHICH MAY RESULT FROM THE USE OF THESE MATERIALS.

MACOM products are not intended for use in medical, lifesaving or life sustaining applications. MACOM customers using or selling MACOM products for use in such applications do so at their own risk and agree to fully indemnify MACOM for any damages resulting from such improper use or sale.