

1.8V to 5.5V, Integrated 2.0A MOSFET 1ch Buck-Boost Converter

BD8306MUV

General Description

ROHM's highly-efficient buck-boost converter BD8306MUV produces buck-boost output voltage including 3.3 V from two-cell or three-cell alkaline battery, or one-cell lithium-ion battery with just one inductor. This IC adopts the original buck-boost drive system and creates a more efficient power supply than the conventional SEPIC-system or H-bridge system switching regulators.

Features

- Highly-Efficient Buck-Boost DC/DC Converter Constructed with just one Inductor.
- Maximum output current changes depending on the input and output voltages. Input current for PVCC terminal should be less than 2.0A including the DC current and ripple current of the inductor. Please refer to Figure 25 and Figure 34 for details about the maximum output current at 3.3V and 5.0V output.
- Incorporates a Soft-Start Function.
- Incorporates a Timer Latch System with Short Protection Function.

Application

- General Portable Equipment
- DSC
- DVC
- Cellular Phone
- PDA
- LED

Typical Application Circuit

2.8V to 5.5V, Output: 3.3V / 1.0 A, Frequency 1MHz

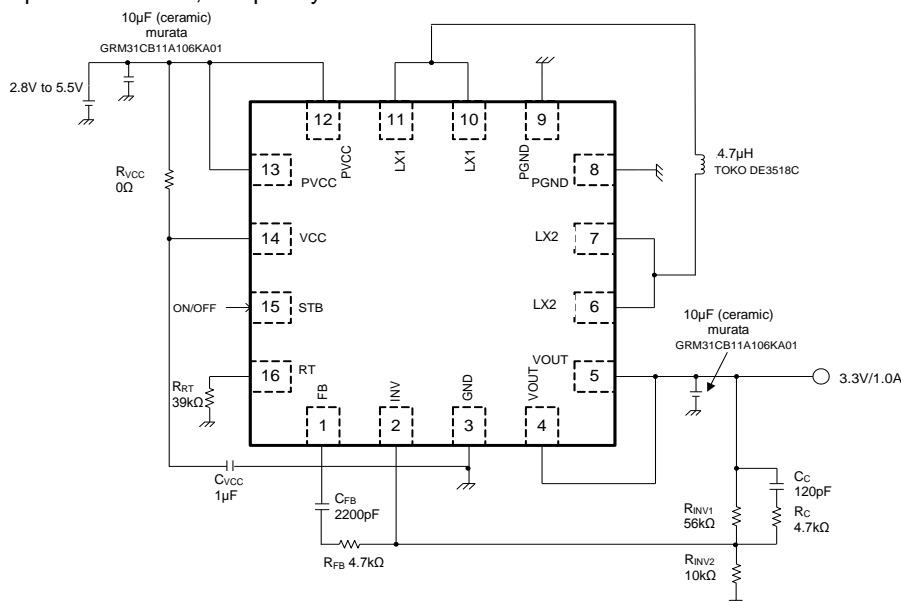

Key Specifications

- Input Voltage Range: +1.8V to +5.5V
- Output Voltage Range: +1.8V to +5.2V
- Output Current:
 - (at 3.3V Output, +2.8V to +5.5V Input) 1.0A
 - (at 5.0V Output, +2.8V to +5.5V Input) 0.7A
- Pch FET ON-Resistance: 120mΩ(Typ)
- Nch FET ON-Resistance: 100mΩ(Typ)
- Standby Current: 0µA (Typ)
- Operating Temperature Range: -40°C to +85°C

Package

W (Typ) x D (Typ) x H (Max)

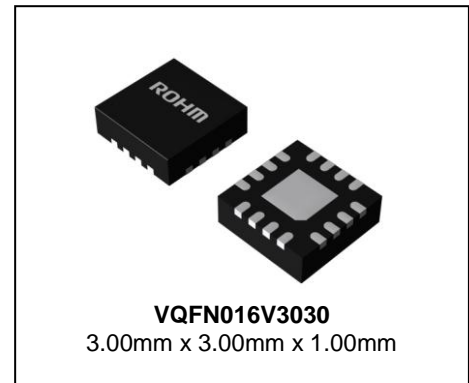

Pin Configuration

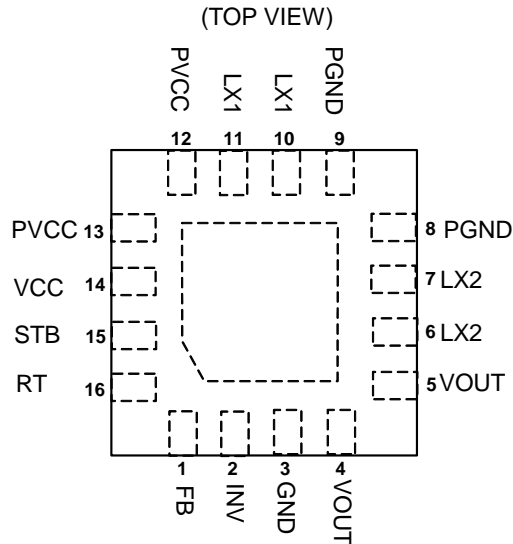

Pin Descriptions

| Pin No. | Pin Name | Function |
|----------|----------|----------------------------------------|
| 1 | FB | Output pin of error amp |
| 2 | INV | Input pin of error amp |
| 3 | GND | Ground pin |
| 4 to 5 | VOUT | Output voltage pin |
| 6 to 7 | LX2 | Output side pin for inductor |
| 8 to 9 | PGND | Ground pin for POW-MOS |
| 10 to 11 | LX1 | Input side pin for inductor |
| 12 to 13 | PVCC | Voltage supply pin for DC/DC converter |
| 14 | VCC | Voltage supply pin for control block |
| 15 | STB | ON/OFF pin |
| 16 | RT | Pin for configuration of frequency |

Block Diagram

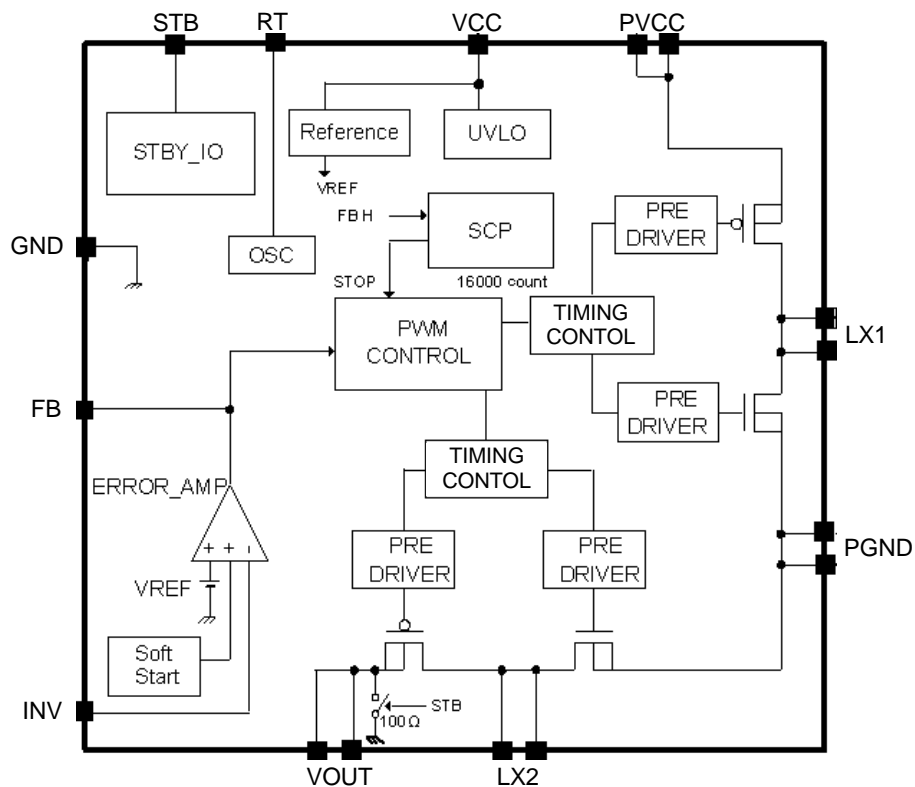

Description of Blocks

1. VREF
This block generates ERROR AMP reference voltage. The reference voltage is 0.5V.
2. UVLO
Circuit for preventing malfunction at low voltage input. This circuit prevents malfunction of the internal circuit while start up of the power supply voltage or while low power supply voltage input. The circuit monitors VCC pin voltage then turns OFF all output FETs and DC/DC converter output when VCC voltage is lower than 1.6V, and reset the timer latch of the internal SCP circuit and soft-start circuit.
3. SCP
Short-circuit protection circuit based on timer latch system.
When the INV pin voltage is lower than 0.5V, the internal SCP circuit starts counting. SCP circuit detects high voltage output of Error AMP. Since internal Error AMP has highly gain as high as 80dB or more, the output voltage of Error AMP goes high and detects SCP even 1mV drop than set voltage (0.5V typ) occurs on INV pin voltage. The internal counter is in synch with OSC, the latch circuit activates after the counter counts about 16400 oscillations to turn OFF DC/DC converter output (about 16.4 msec when $R_{RT} = 39k\Omega$). To reset the latch circuit, turn OFF the STB pin once. Then, turn it ON again or turn on the power supply voltage again.
4. OSC
Oscillation circuit to change frequency by external resistance of the RT pin (Pin 16).
When $R_{RT} = 39 k\Omega$, operation frequency of DC/DC converter is set at 1 MHz.
5. ERROR AMP
Error amplifier for monitoring output voltage and output PWM control signals.
The internal reference voltage for Error AMP is set at 0.5 V.
6. PWM COMP
Voltage-pulse width converter for controlling output voltage corresponding to input voltage. Comparing the internal SLOPE waveform with the ERROR AMP output voltage, PWM COMP controls the pulse width and outputs to the driver. Max Duty and Min Duty are set at the primary side (LX1) and the secondary side (LX2) of the inductor respectively, which are as follows:

| | |
|----------------------|----------------------------------------------|
| Primary side (LX1) | Max Duty : 100 %(LX1 High side PMOS ON Duty) |
| | Min Duty : 0 %(LX1 High side PMOS ON Duty) |
| Secondary side (LX2) | Max Duty : 85 %(LX2 Low side NMOS ON Duty) |
| | Min Duty : 0 %(LX2 Low side NMOS ON Duty) |
7. SOFT START
Circuit for preventing in-rush current at startup by bringing the output voltage of the DC/DC converter into a soft-start. Soft-start time is in synch with the internal OSC, and the output voltage of the DC/DC converter reaches the set voltage after about 1000 oscillations (About 1 msec when $R_{RT} = 39 k\Omega$).
8. PRE DRIVER
CMOS inverter circuit for driving the built-in Pch/Nch FET. Dead time is provided for preventing feed through during switching. The dead time is set at about 15 nsec for each individual SWs.
9. STBY_IO
Voltage applied on STB pin (Pin 15) to control ON/OFF of IC.
Turned ON when a voltage of 1.5V or higher is applied and turned OFF when the terminal is open or 0V is applied. Incorporates approximately 400 k Ω pull-down resistance.
10. Pch/Nch FET SW
Built-in SW for switching the inductor current of the DC/DC converter. Pch FET is about 120m Ω and Nch is 100m Ω . Since the current rating of this FET is 2A, it should be used within 2A in total including the DC current and ripple current of the inductor. The peak current of the inductor can be calculated by equation (1), (2), (3).

Absolute Maximum Ratings

| Parameter | Symbol | Rating | Unit |
|------------------------------|-------------------|-------------|------|
| Maximum Input Supply Voltage | V_{CC}, PV_{CC} | -0.3 to +7 | V |
| Maximum Input Current | I_{INMAX} | 2.0 | A |
| Maximum Input Voltage | V_{LX1} | 7.0 | V |
| | V_{LX2} | 7.0 | V |
| Power Dissipation (Note 1) | P_d | 0.62 | W |
| Storage Temperature | T_{stg} | -55 to +150 | °C |
| Junction Temperature | T_{jmax} | +150 | °C |

(Note 1) When mounted on 74.2x74.2x1.6mm and operated over 25°C P_d reduces by 4.96mW/°C.

Caution: Operating the IC over the absolute maximum ratings may damage the IC. The damage can either be a short circuit between pins or an open circuit between pins and the internal circuitry. Therefore, it is important to consider circuit protection measures, such as adding a fuse, in case the IC is operated over the absolute maximum ratings.

Recommended Operating Conditions($T_a=25^\circ\text{C}$)

| Parameter | Symbol | Rating | | | Unit |
|-----------------------------|-----------|--------|-----|-----|------|
| | | Min | Typ | Max | |
| Power Supply Voltage Range | V_{CC} | 1.8 | - | 5.5 | V |
| Output Voltage Range | V_{OUT} | 1.8 | - | 5.2 | V |
| Operating Temperature Range | T_{opr} | -40 | - | +85 | °C |

Electrical Characteristics (Unless otherwise specified Ta=25°C, V_{CC}=3V)

| Parameter | Symbol | Limit | | | Unit | Conditions | |
|----------------------------------|--------------------|-------------------|-------|-------|------|-----------------------------------------------|--|
| | | Min | Typ | Max | | | |
| [Under Voltage Lock Out Circuit] | | | | | | | |
| Reset Voltage | V _{UV} | - | 1.7 | 1.8 | V | V _{CC} sweep up | |
| Hysteresis Width | ΔV _{UVHY} | 50 | 100 | 150 | mV | | |
| [Oscillator] | | | | | | | |
| Frequency | f _{OSC} | 0.9 | 1.0 | 1.1 | MHz | R _{RT} =39KΩ | |
| [Error AMP] | | | | | | | |
| Input Threshold Voltage | V _{INV} | 0.495 | 0.500 | 0.505 | V | | |
| Input Bias Current | I _{INV} | -50 | 0 | +50 | nA | V _{CC} =7.0V, V _{INV} =3.5V | |
| Soft Start Time | t _{SS} | 0.60 | 1.00 | 1.40 | msec | R _{RT} =39kΩ | |
| Output Source Current | I _{EO} | 10 | 20 | 30 | μA | V _{INV} =0.2V, V _{FB} =1.5V | |
| Output Sink Current | I _{EI} | 0.6 | 1.2 | 2.4 | mA | V _{INV} =0.8V, V _{FB} =1.5V | |
| [PWM Comparator] | | | | | | | |
| LX1 Max Duty | D _{MAX1} | - | - | 100 | % | High side ON Duty | |
| LX2 Max Duty | D _{MAX2} | 77 | 85 | 93 | % | Low side ON Duty | |
| [Output] | | | | | | | |
| LX1 PMOS ON-Resistance | R _{ON1P} | - | 120 | 200 | mΩ | V _{GS} =3.0V | |
| LX1 NMOS ON-Resistance | R _{ON1N} | - | 100 | 160 | mΩ | V _{GS} =3.0V | |
| LX2 PMOS ON-Resistance | R _{ON2P} | - | 120 | 200 | mΩ | V _{GS} =3.0V | |
| LX2 NMOS ON-Resistance | R _{ON2N} | - | 100 | 160 | mΩ | V _{GS} =3.0V | |
| VOUT Discharge Switch | R _{DVO} | - | 100 | 160 | Ω | V _{GS} =3.0V, on at STB OFF | |
| LX1 OCP Threshold | I _{OCP} | 2.0 | 3.0 | - | A | PV _{CC} =3.0V | |
| LX1 Leak Current | I _{LEAK1} | -1 | 0 | +1 | μA | | |
| LX2 Leak Current | I _{LEAK2} | -1 | 0 | +1 | μA | | |
| [STB] | | | | | | | |
| STB Pin Control Voltage | Enable | V _{STBH} | 1.5 | - | 5.5 | V | |
| | Disable | V _{STBL} | -0.3 | - | +0.3 | V | |
| STB Pull Down Resistance | R _{STB} | 250 | 400 | 700 | kΩ | | |
| [Circuit Current] | | | | | | | |
| Stand-By Current | VCC Pin | I _{STB1} | - | - | 1 | μA | |
| | PVCC Pin | I _{STB2} | - | - | 1 | μA | |
| VCC Circuit Current | I _{CC1} | - | 500 | 750 | μA | (Note 2) V _{INV} =0.8V, stop DC/DC | |
| PVCC Circuit Current | I _{CC2} | - | 10 | 20 | μA | (Note 2) V _{INV} =0.8V, stop DC/DC | |
| VOUT Circuit Current | I _{CC3} | - | 10 | 20 | μA | (Note 2) V _{INV} =0.8V, stop DC/DC | |

(Note 2) I_{CC1}, I_{CC2}, I_{CC3} are currents flowing to VCC, PVCC, VOUT terminals. When the input voltage of INV pin is 0.8V, DC/DC converter operation stops. Total input current on DC/DC converter operation would be greater than the limit mentioned above. Please refer to Figure 26 and Figure 35 for details about the total input current under DC/DC converter operation at 3.3V and 5.0V output.

Typical Performance Curves

(Unless otherwise specified, $T_a = 25^\circ\text{C}$, $V_{CC} = 3.7\text{V}$)

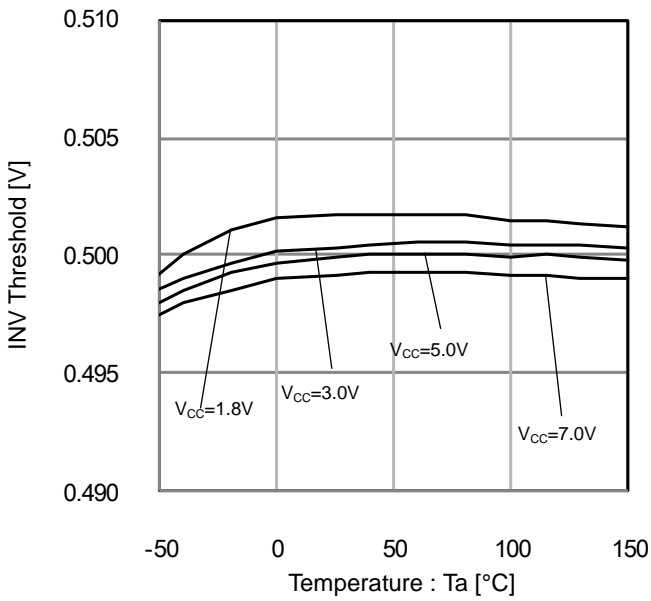

Figure 1. INV Threshold vs Temperature

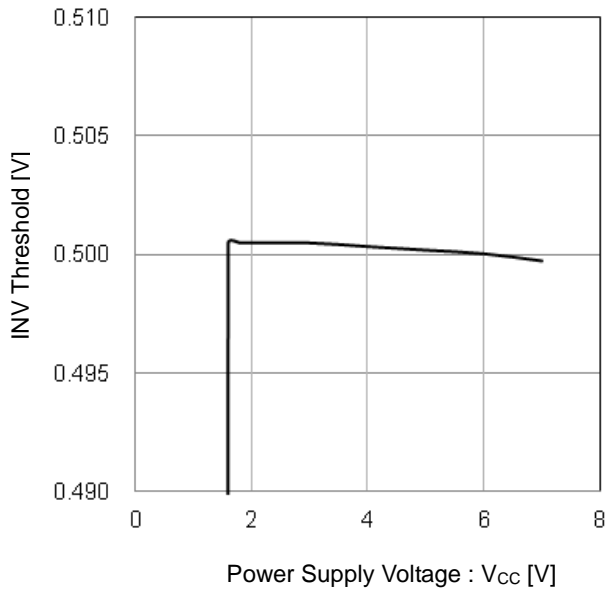

Figure 2. INV Threshold vs Power Supply Voltage

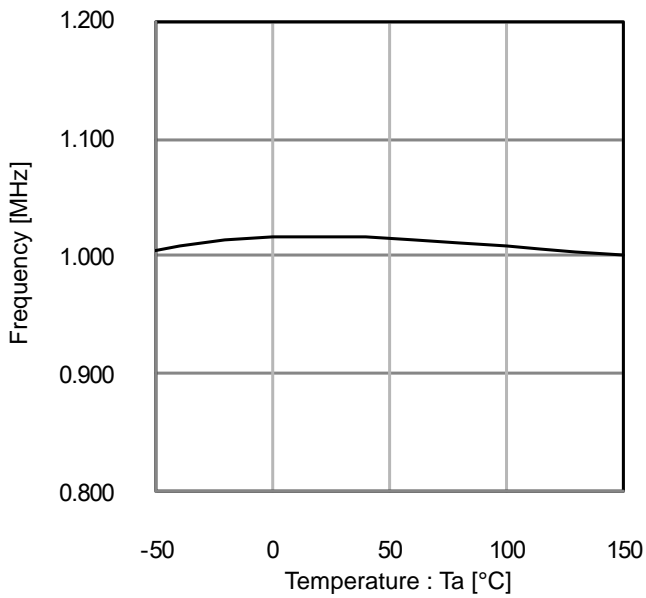

Figure 3. Oscillation Frequency vs Temperature

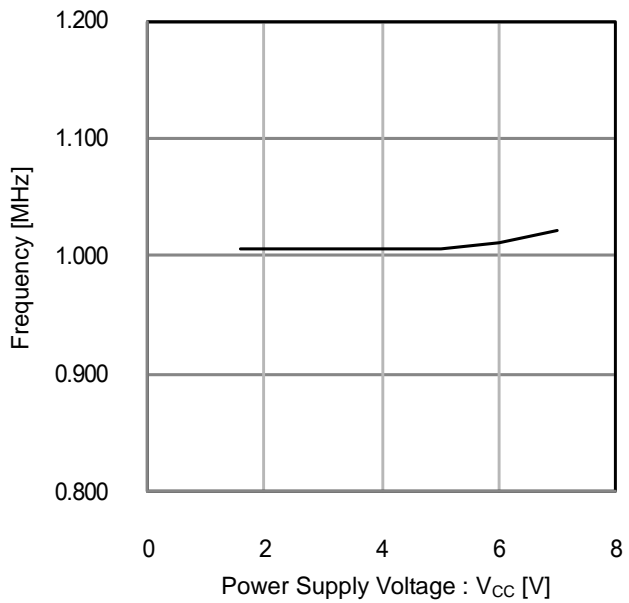

Figure 4. Oscillation Frequency vs Power Supply Voltage

Typical Performance Curves - continued

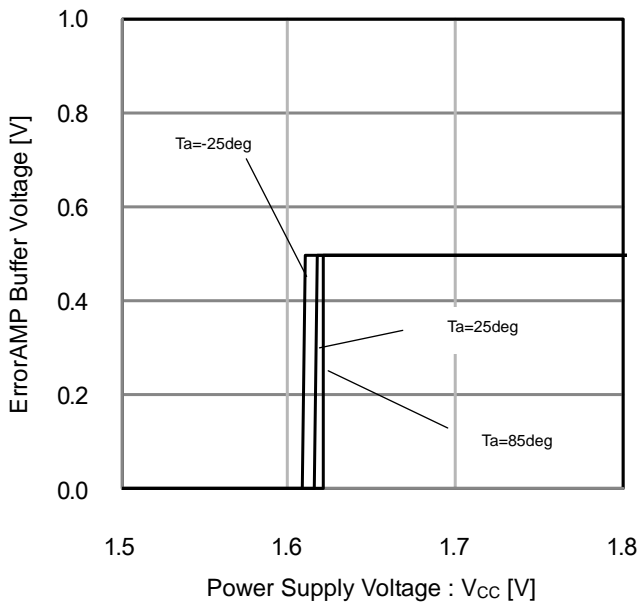

Figure 5. ErrorAmp Buffer Voltage vs Power Supply Voltage (UVLO Detect Threshold)

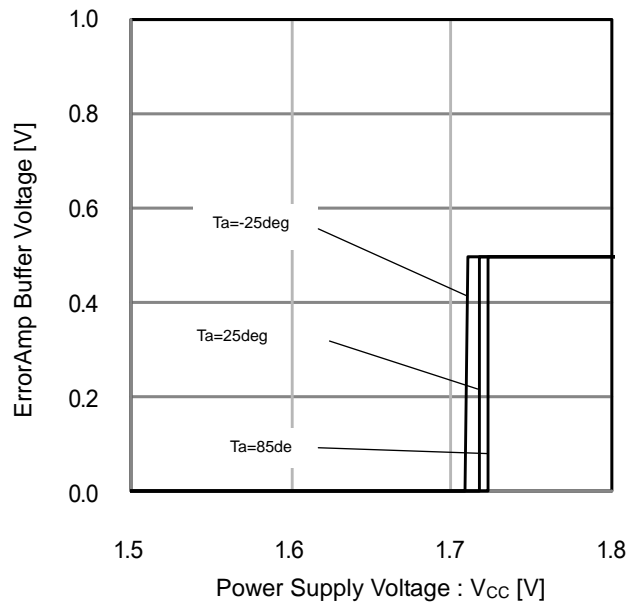

Figure 6. ErrorAmp Buffer Voltage vs Power Supply Voltage (UVLO Reset Threshold)

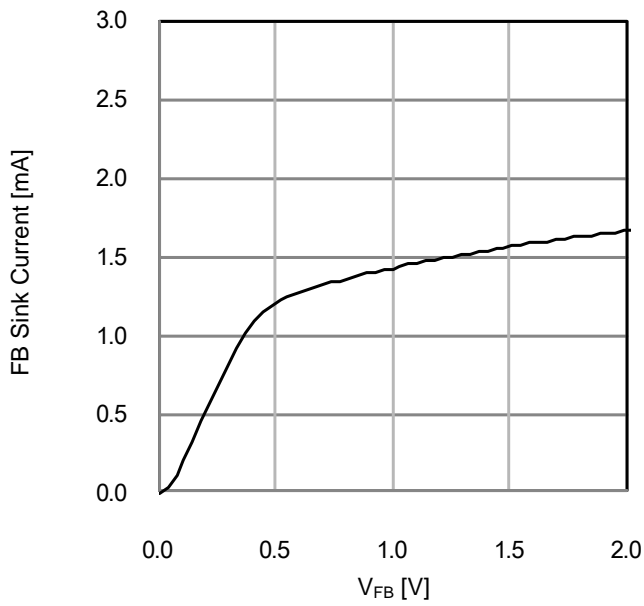

Figure 7. FB Sink Current vs V_{FB} ($V_{INV}=0.8V$)

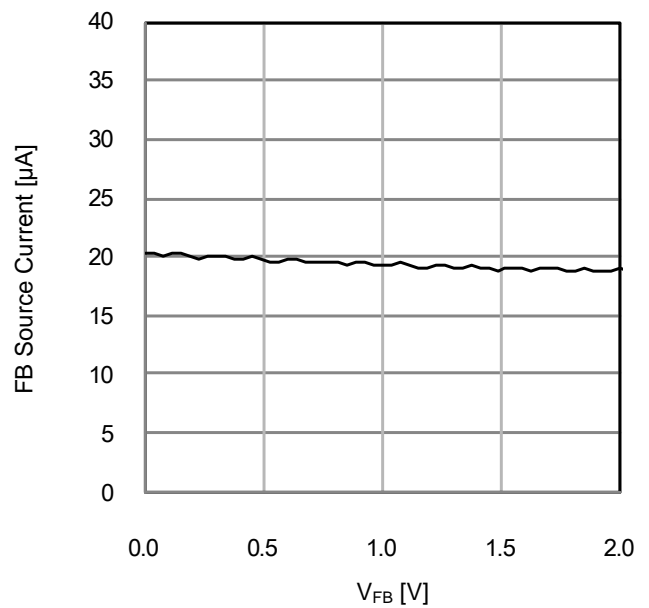

Figure 8. FB Source Current vs V_{FB} ($V_{INV}=0.2V$)

Typical Performance Curves - continued

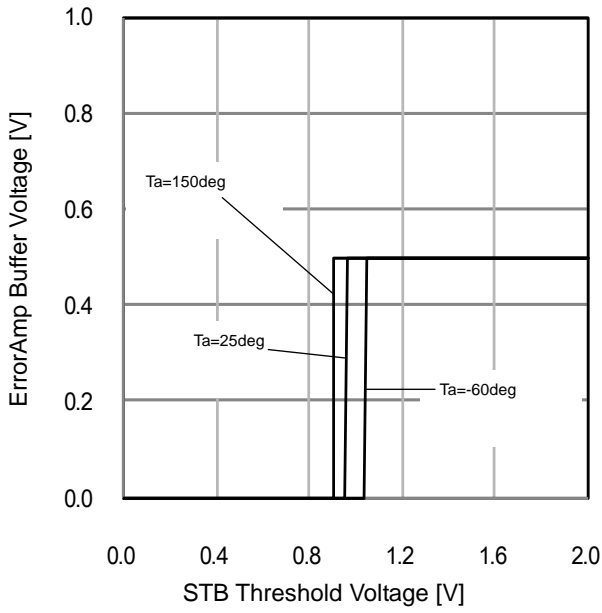

Figure 9. Error Amp Buffer Voltage vs STB Threshold Voltage

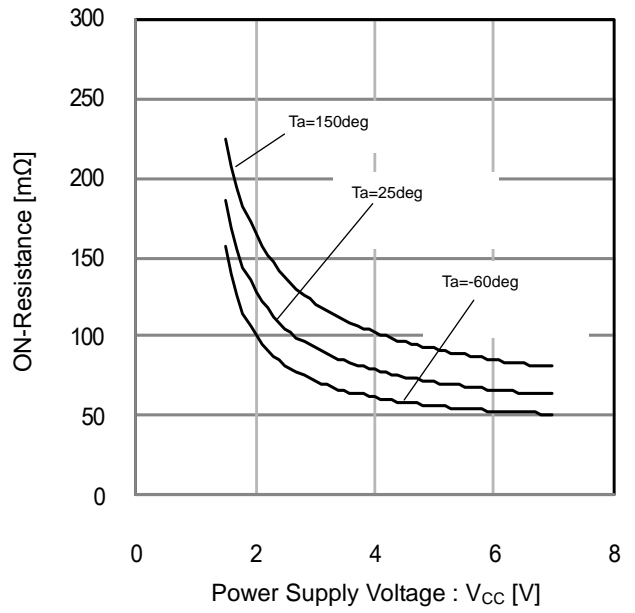

Figure 10. ON-Resistance vs Power Supply Voltage (LX1 Pch FET)

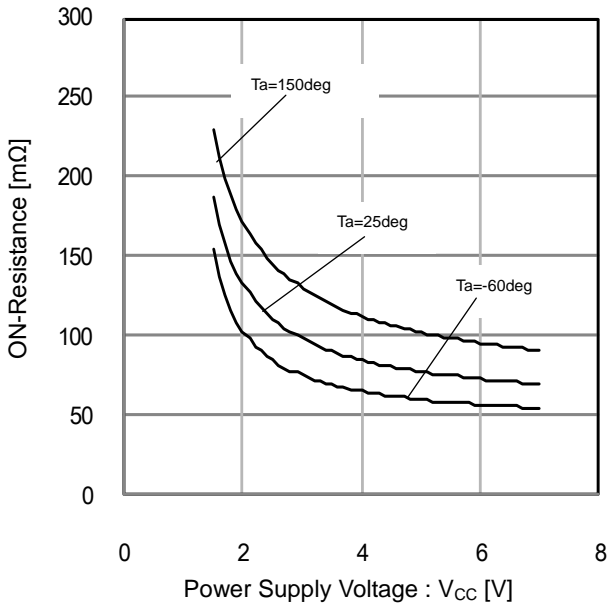

Figure 11. ON-Resistance vs Power Supply Voltage (LX1 Nch FET)

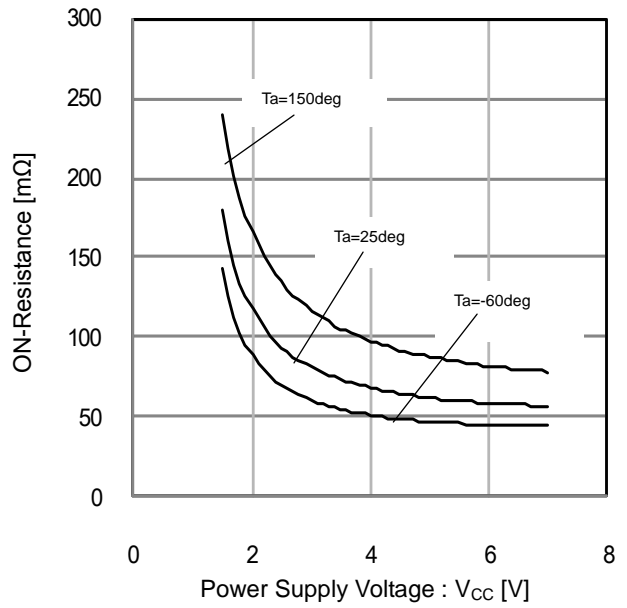

Figure 12. ON-Resistance vs Power Supply Voltage (LX2 Pch FET)

Typical Performance Curves - continued

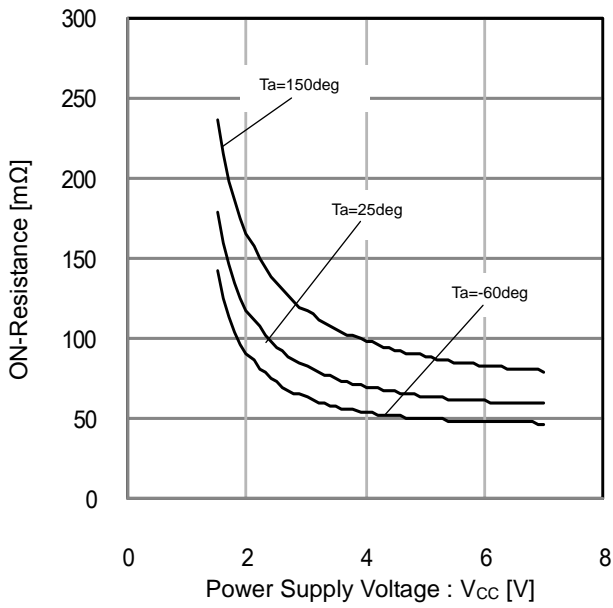

Figure 13. ON-Resistance vs Power Supply Voltage (LX2 Nch FET)

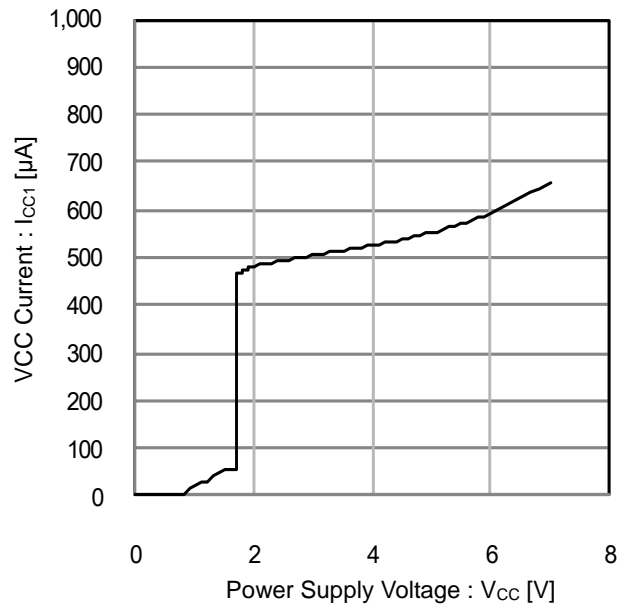

Figure 14. VCC Input Current vs Power Supply Voltage (V_{INV}=0.8V, stop DC/DC)

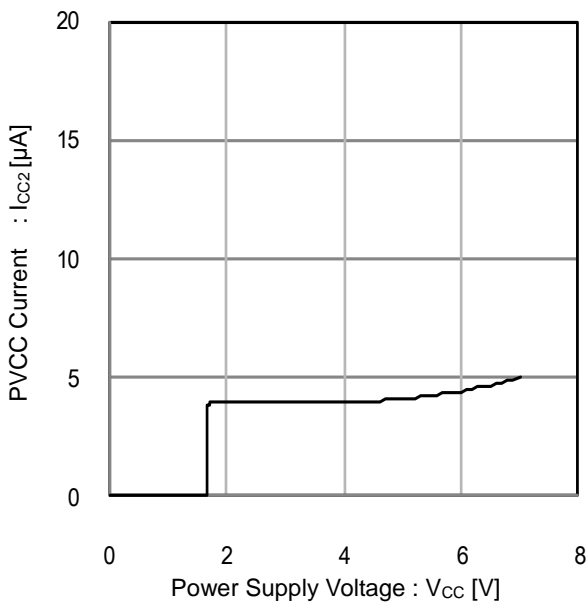

Figure 15. PVCC Input Current vs Power Supply Voltage (V_{INV}=0.8V, stop DC/DC)

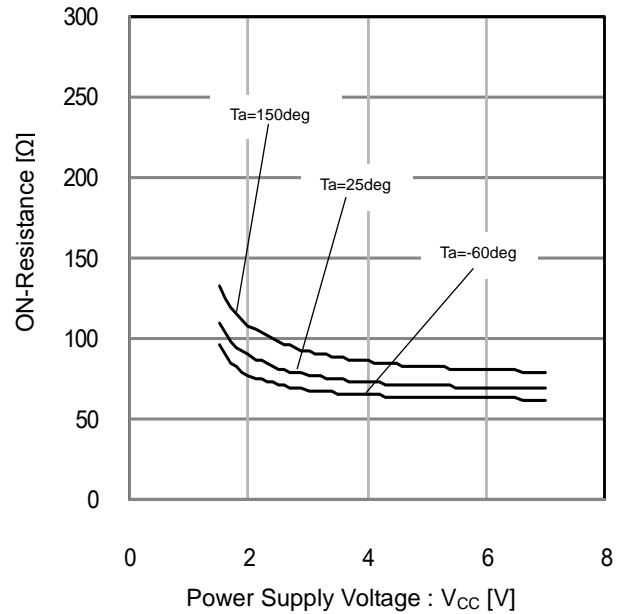

Figure 16. ON-Resistance vs Power Supply Voltage (V_{STB}=0V) (V_{out} discharge SW)

Typical Performance Curves - continued

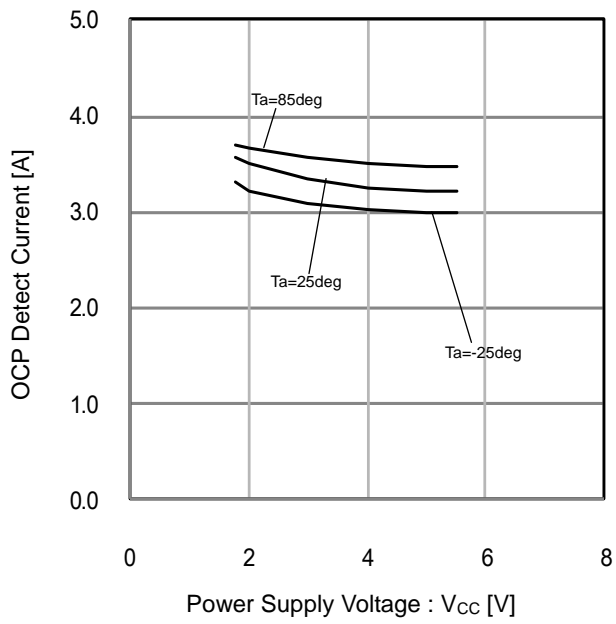

Figure 17. OCP Detect Current vs Power Supply Voltage

Application Information

1. Application Circuit [1] Input: 2.8V to 5.5V, Output: 3.3V / 1.0A, Frequency 1MHz

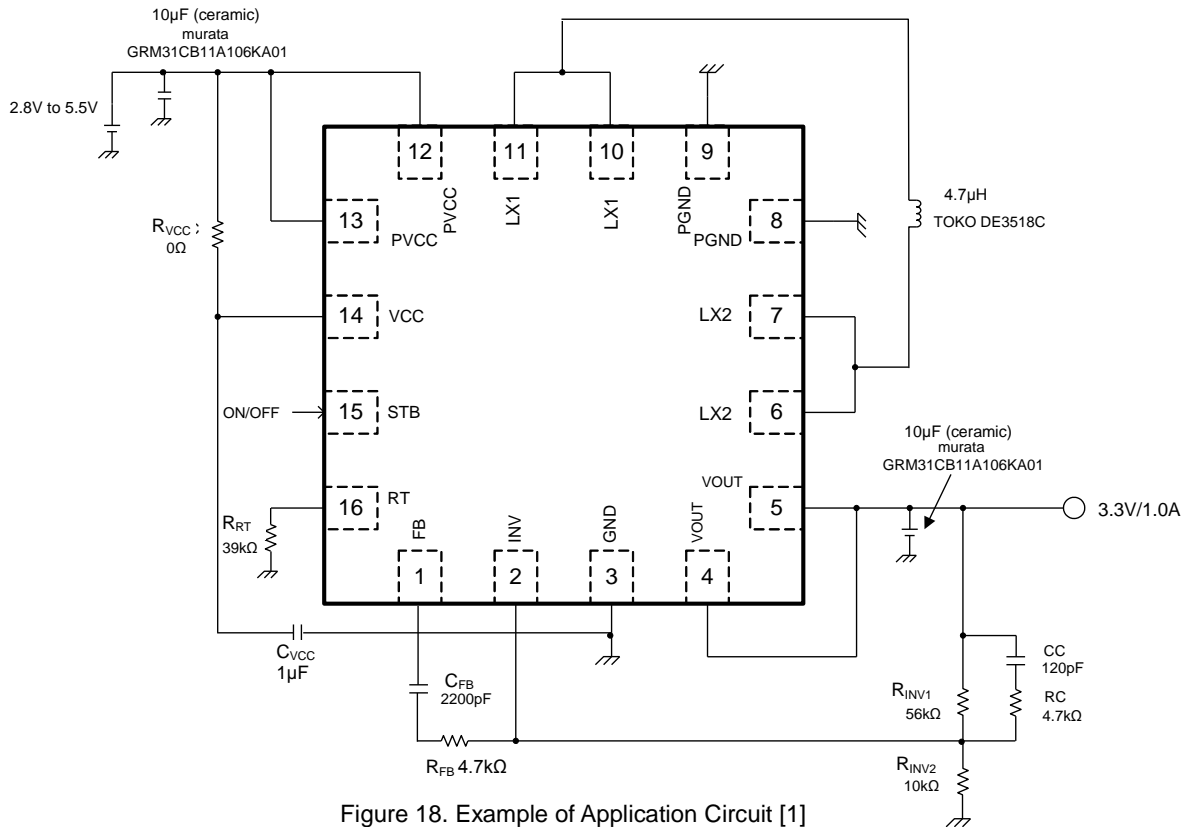

Figure 18. Example of Application Circuit [1]

2. Application Circuit [2] Input: 2.8V to 5.5V, Output: 5.0V / 0.7A, Frequency 1MHz

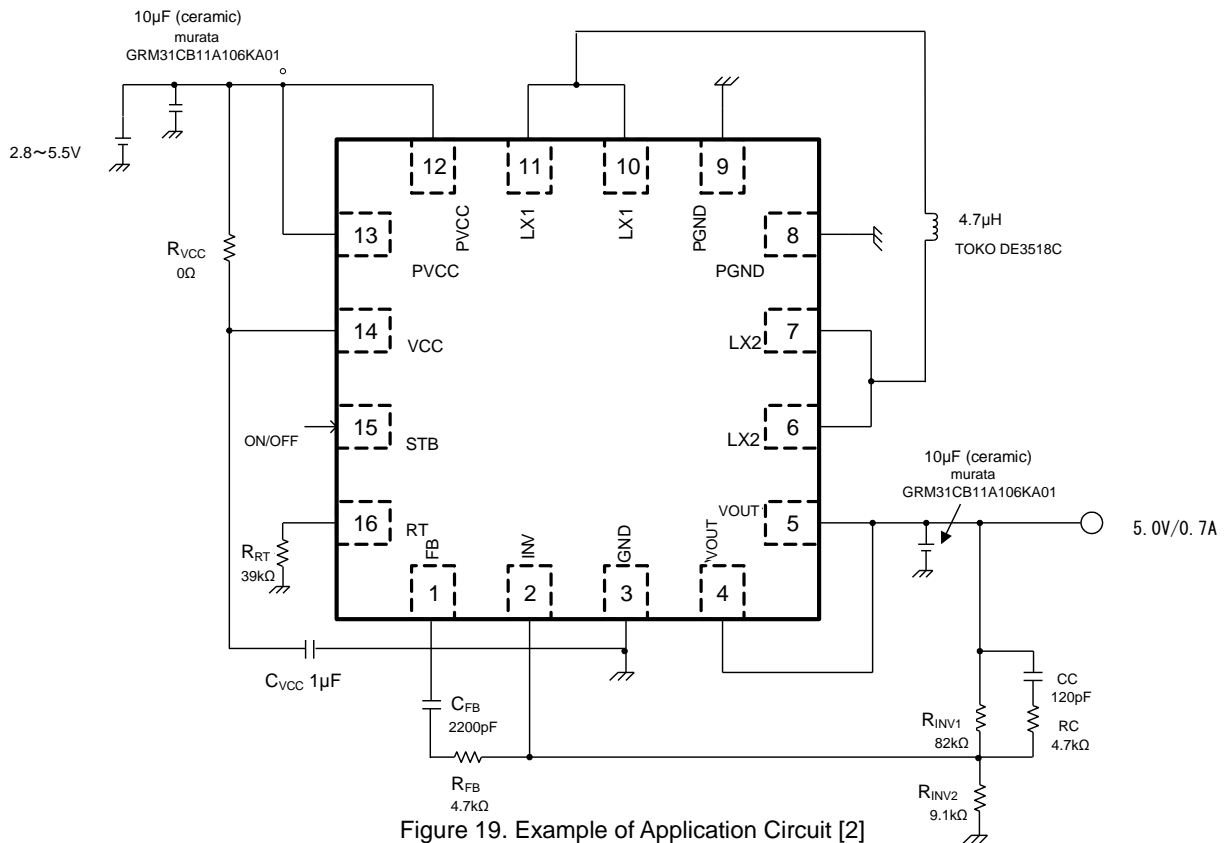

Figure 19. Example of Application Circuit [2]

3. Sample Board Layout

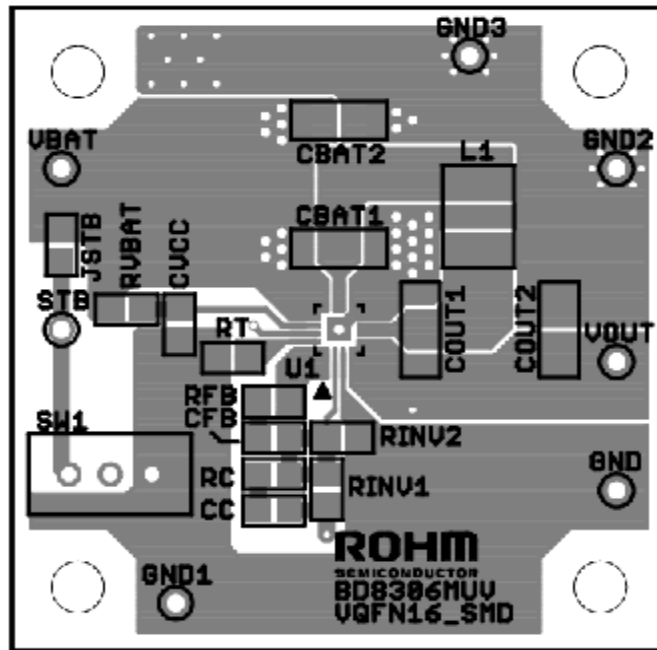

Figure 20. Assembly Layer

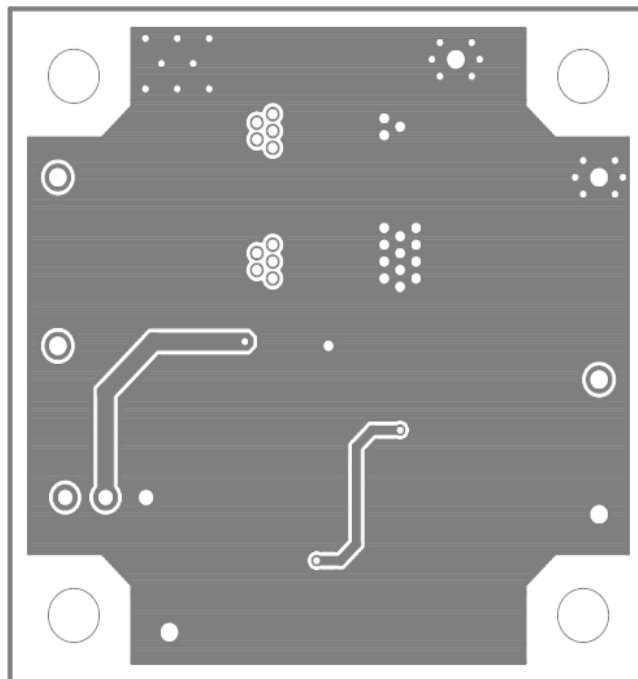

Figure 21. Bottom Layer

4. Reference Application Data (Unless otherwise specified, $T_a = 25^\circ\text{C}$, $V_{CC} = 3.7\text{ V}$)
 Sample Application 1

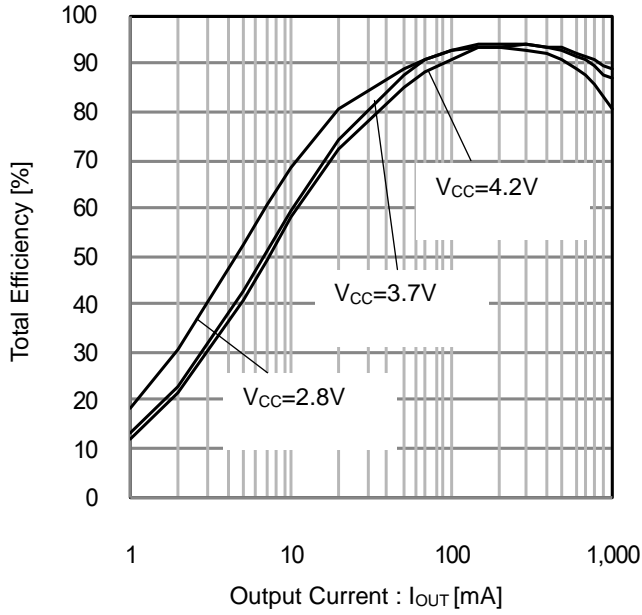

Figure 22. Total Efficiency vs Output Current (Power Conversion Efficiency)

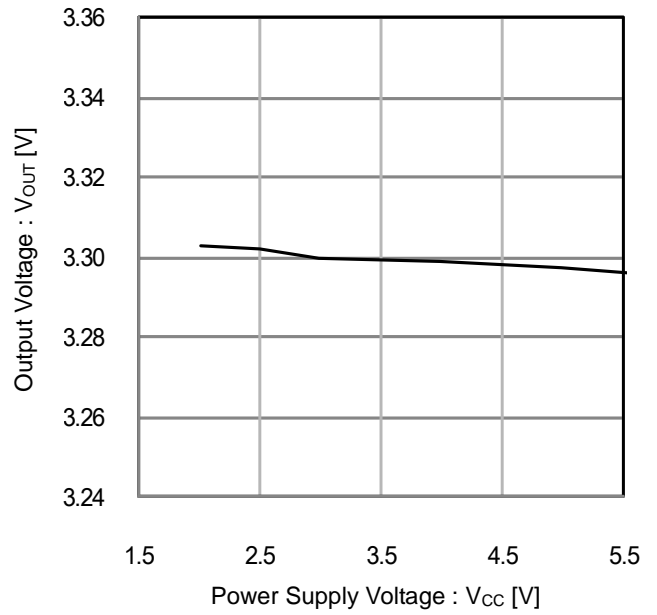

Figure 23. Output Voltage vs Power Supply Voltage (Output Current = 500mA)

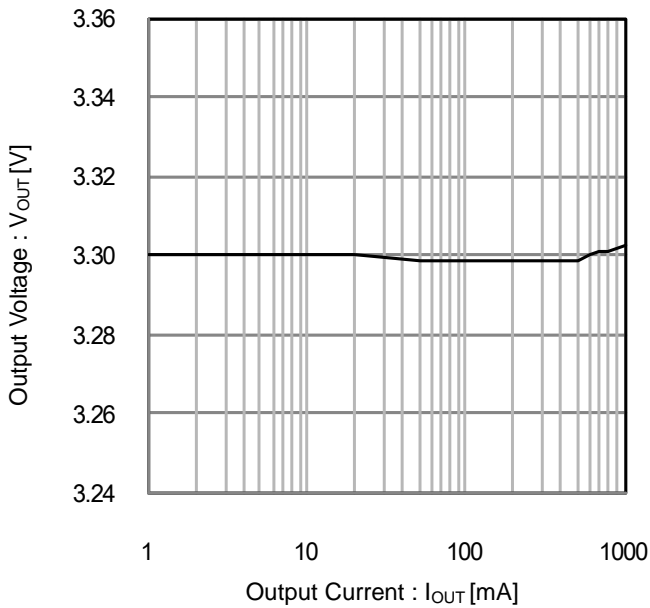

Figure 24. Output Voltage vs Output Current

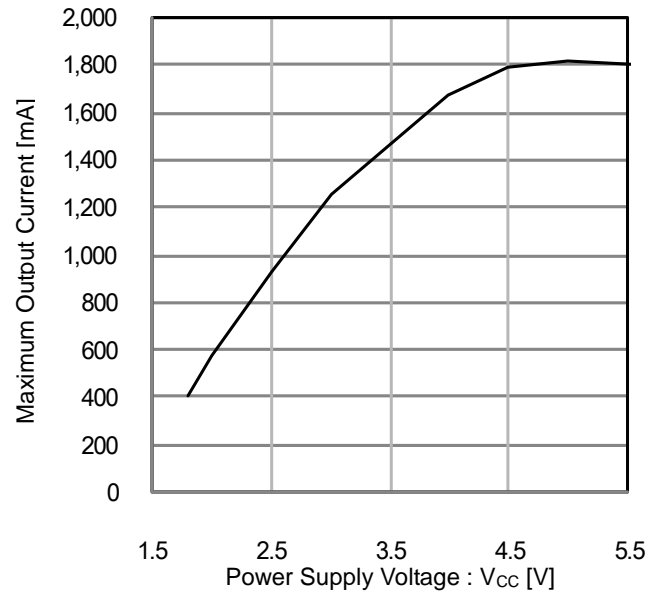

Figure 25. Maximum Output Current vs Power Supply Voltage

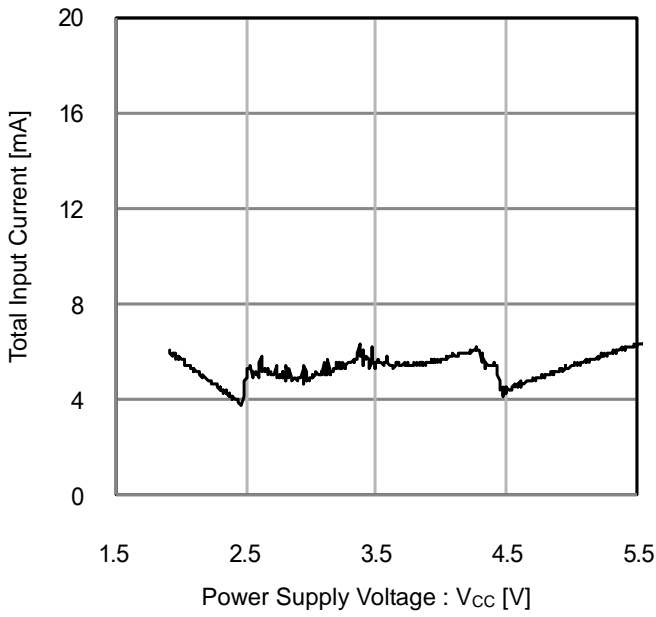

Figure 26. Total Input Current vs Power Supply Voltage (Output Current = 0mA)

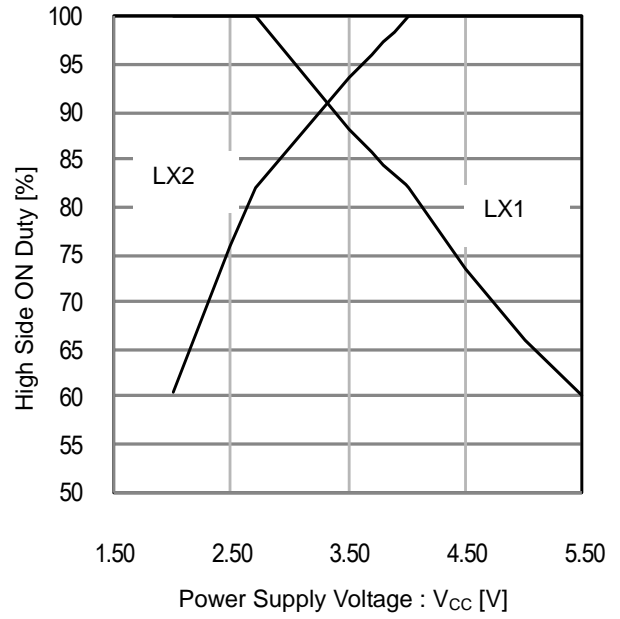

Figure 27. High Side ON Duty vs Power Supply Voltage (LX1, LX2)

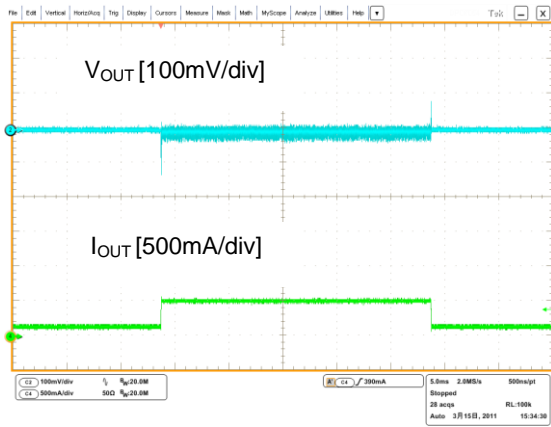

Figure 28. Output Current Response (Output Current = 100mA ⇔ 500mA 5msec/div)

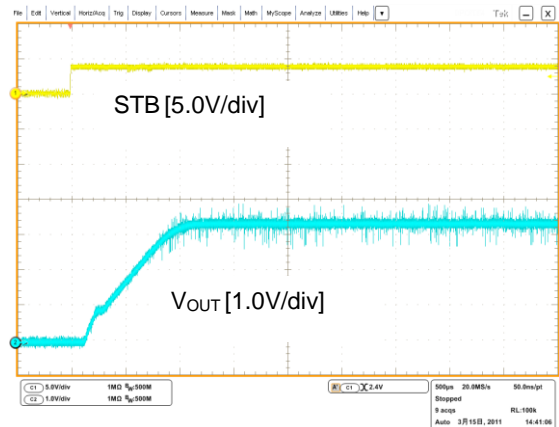

Figure 29. Soft Start Waveform (STB: Low to High 500µsec/div)

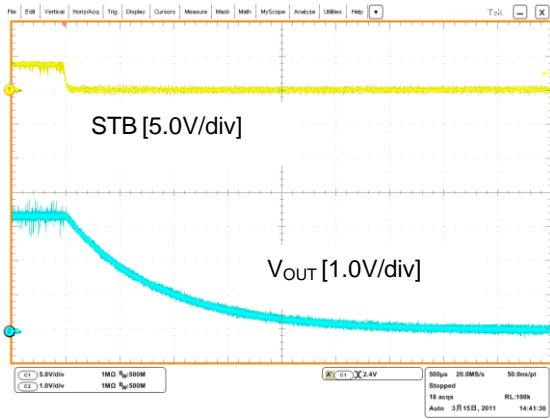

Figure 30. Discharge Waveform
(STB: High to Low
500μsec/div)

5. Reference Application Data (Unless otherwise specified, $T_a = 25^\circ\text{C}$, $V_{CC} = 3.7\text{V}$)
Sample Application 2

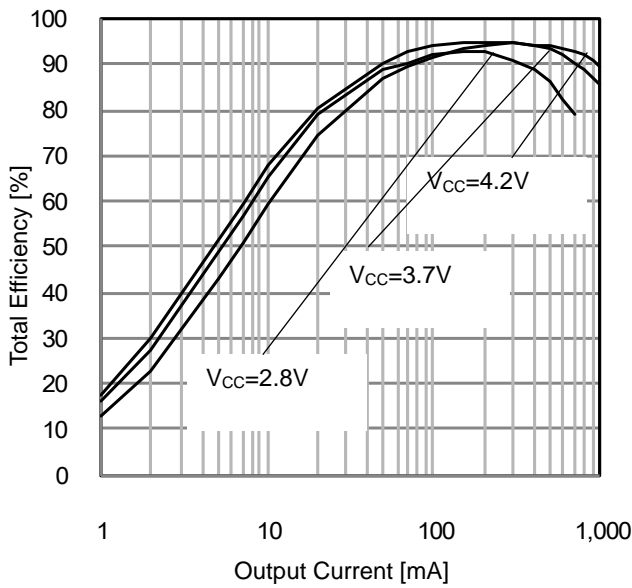

Figure 31. Total Efficiency vs Output Current
(Power Conversion Efficiency)

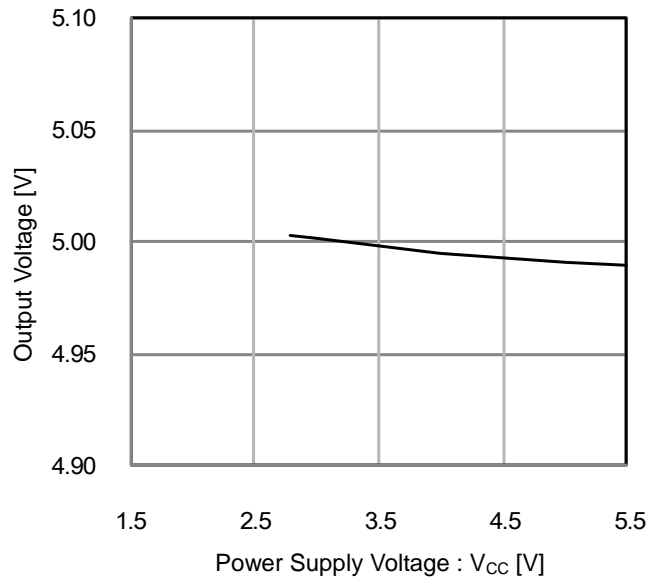

Figure 32. Output Voltage vs Power Supply Voltage
(Output Current = 500mA)

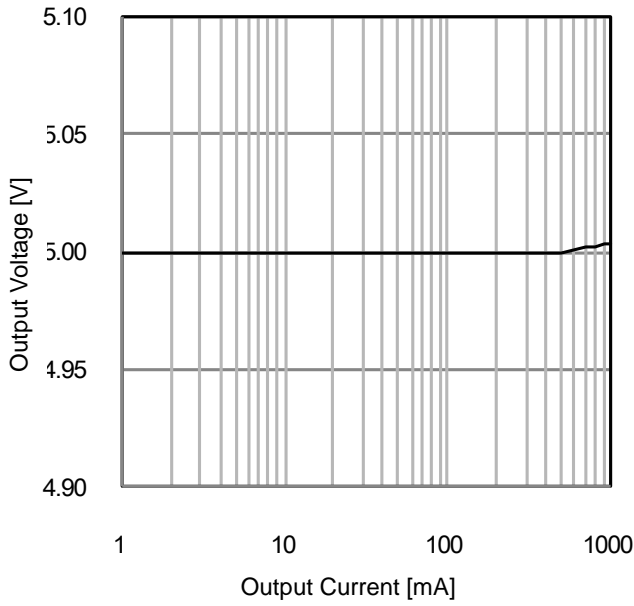

Figure 33. Output Voltage vs Output Current

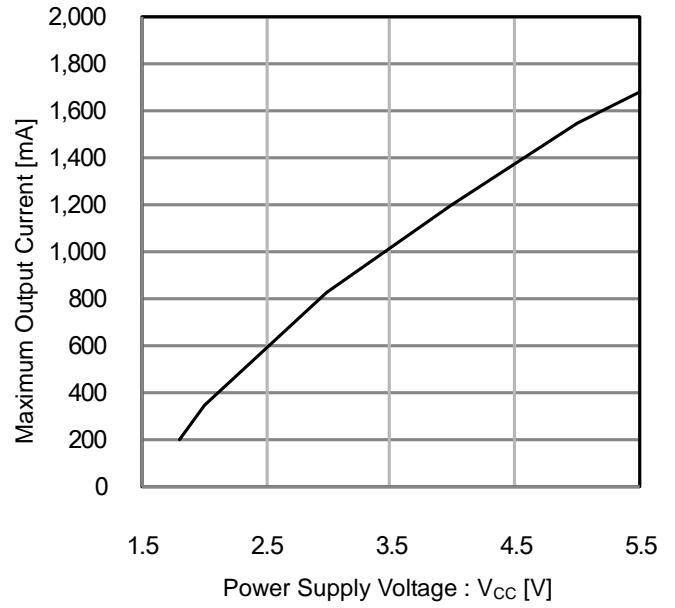

Figure 34. Maximum Output Current vs Power Supply Voltage

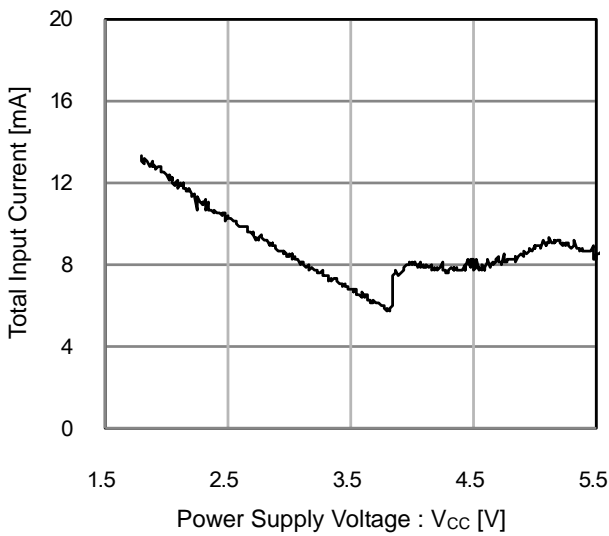

Figure 35. Total Input Current vs Power Supply Voltage (Output Current = 0mA)

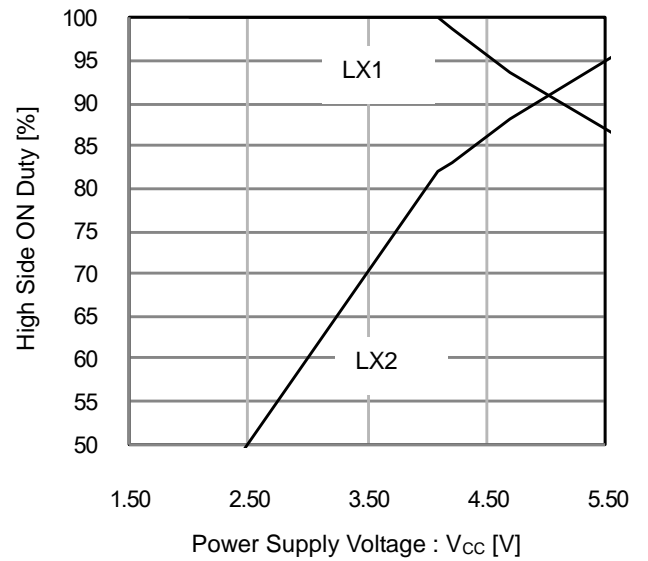

Figure 36. High Side ON Duty vs Power Supply Voltage (LX1, LX2)

6. Selection of Parts for Application

(1) Output Inductor

A shielded inductor that satisfies the current rating (current value, I_{PEAK} as shown in the drawing below) and has a low DCR (direct current resistance component) is recommended. Inductor values affect output ripple current greatly. Ripple current can be reduced as the inductor L value becomes larger and the switching frequency becomes higher as shown in the equations below.

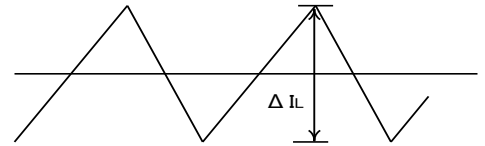

Figure 37. Ripple Current

$$I_{PEAK} = I_{OUT} + \frac{(V_{IN} - V_{OUT}) \times V_{OUT}}{2 \times L \times V_{IN} \times f} \quad [A] \quad ; \text{ (in step-down mode) } \quad (1)$$

$$I_{PEAK} = \frac{I_{OUT} \times (V_{IN} + V_{OUT})}{2 \times Dc \times V_{IN} \times \eta} + \frac{[V_{IN} - V_{OUT}] \times V_{OUT} \times Dc}{L \times (V_{IN} + V_{OUT}) \times f} \quad [A] \quad ; \text{ (in buck-boost mode) } \quad (2)$$

$$I_{PEAK} = \frac{I_{OUT} \times V_{OUT}}{V_{IN} \times \eta} + \frac{(V_{OUT} - V_{IN}) \times V_{IN}}{2 \times L \times V_{OUT} \times f} \quad [A] \quad ; \text{ (in step-up mode) } \quad (3)$$

Where:

η is the Efficiency (<0.96)

Dc is the Cross Point Duty (≈ 0.91)

f is the Switching Frequency

L is the Inductance

As a guide, output ripple current should be set at about 20% to 50% of the maximum output current.

(Note) Current flow that exceeds the coil rating brings the coil into magnetic saturation, which may lead to lower efficiency or output oscillation. Select an inductor with an adequate margin so that the peak current does not exceed the rated current of the coil.

(2) Output Capacitor

A ceramic capacitor with a low ESR is recommended at the output in order to reduce output ripple. There must be an adequate margin between the maximum rating and output voltage of the capacitor, taking the DC bias property into consideration. Output ripple voltage when ceramic capacitor is used is obtained by the following equation. Setting must be performed so that output ripple is within the allowable ripple voltage.

$$V_{PP} = \Delta I_L \times \frac{1}{2\pi \times f \times C_O} + \Delta I_L \times R_{ESR} \quad [V] \quad (4)$$

(3) Setting of Oscillation Frequency

Oscillation frequency can be set using a resistance value connected to the RT pin (Pin 16). The oscillation frequency is set at 1 [MHz] when $R_{RT} = 39$ [K Ω], wherein frequency is inversely proportional to RT value. See Figure 38 for the relationship between RT [K Ω] and frequency. Soft-start time changes along with oscillation frequency. See Figure 39 for the relationship between RT [K Ω] and soft-start time. Frequency is calculated by the following equation.

$$f_{OSC} = 39 / RT \times 1000 [KHz] \quad (5)$$

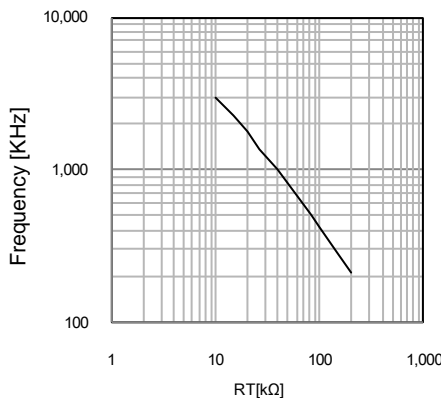

Figure 38. Oscillation Frequency vs RT Pin Resistance

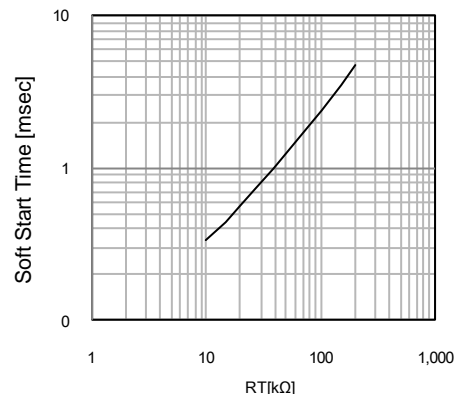
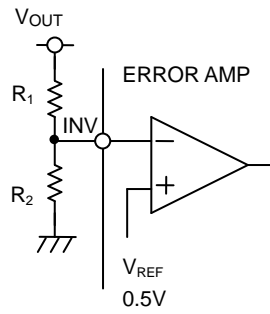

Figure 39. Soft-Start Time vs RT Pin Resistance

Note: that the above example of frequency setting is just a design target value, and may differ from the actual equipment.

(4) Output Voltage Setting

The internal reference voltage of the ERROR AMP is 0.5V. Output voltage should be obtained by referring to Equation (6) of Figure 40.



$$V_{OUT} = \frac{(R_1 + R_2)}{R_2} \times 0.5 \quad [V] \quad (6)$$

Figure 40. Setting of Feedback Resistance

(5) Determination of Phase Compensation

The condition for feedback system stability under negative feedback is as follows:

Phase delay must be 135° or lower when gain is 1 (0 dB) (Phase margin is 45° or higher). Since DCDC converter application is sampled according to the switching frequency, the Gain-BW of the whole system (frequency at which gain is 0dB) must be set to be equal to or lower than 1/5 of the switching frequency.

- (a) Phase delay must be 135° or lower when gain is 1 (0 dB) (Phase margin is 45° or higher).
- (b) The Gain-BW at that time (frequency when gain is 0dB) must be equal to or lower than 1/5 of the switching frequency. For this reason, switching frequency must be increased to improve responsiveness.

One of the points to secure stability by phase compensation is to cancel the second dimensional phase delay (-180°) generated by LC resonance of the second dimensional phase lead (i.e. put two phase leads).

Since f_{GBW} is determined by the phase compensation capacitor attached to the error amplifier, the capacitor should be made larger when it is necessary to reduce f_{GBW} .

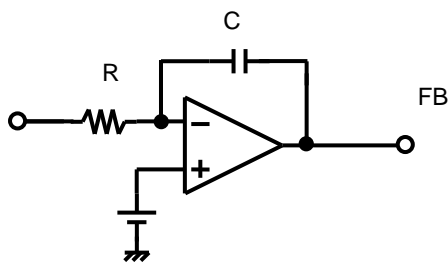

Figure 41. General Integrator

Error AMP is a low-pass filter because phase compensation by RC is performed as shown below. For DC/DC converter application, R is a parallel feedback resistance.

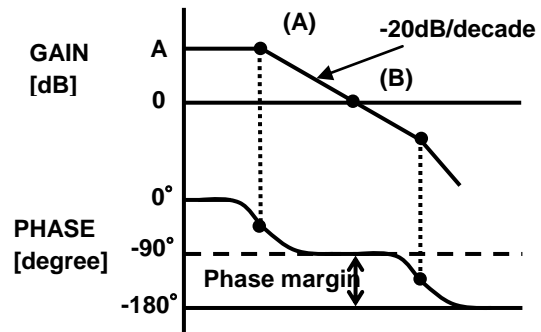

Figure 42. Frequency Property of Integrator

$$Point(A) \quad f_p = \frac{1}{2\pi R C A} \quad [Hz] \quad (7)$$

$$Point(B) \quad f_{GBW} = \frac{1}{2\pi R C} \quad [Hz] \quad (8)$$

Phase compensation using an output capacitor with a low ESR such as ceramic capacitor is as follows:

When an output capacitor with a low ESR (several tens of mΩ) is used at the output, the secondary phase lead (two phase leads) must be put to cancel the secondary phase lead caused by LC. One example of phase compensation methods is as follows:

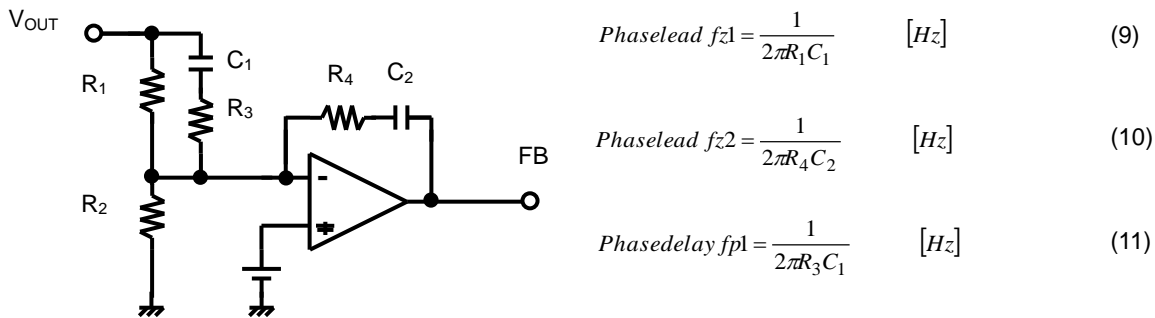

Figure 43. Example of Setting of Phase Compensation

$$\text{LC resonance frequency (in step-down mode)} = \frac{1}{2\pi\sqrt{LC_{out}}} \quad [Hz] \quad (12)$$

$$\text{LC resonance frequency (in step-up mode)} = \frac{1-D}{2\pi\sqrt{LC_{out}}} \quad [Hz] \quad (13)$$

$$D : ON \frac{V_{OUT} - V_{IN}}{V_{OUT}}$$

Cout : OutputCapacitor

For setting of phase-lead frequency (9) and (10), both of them should be put near the LC resonance frequency (12) or (13).

When f_{GBW} frequency becomes too high due to the secondary phase lead, it may be stabilized by setting the primary phase delay (11) to a frequency slightly higher than the LC resonance frequency by R_3 to compensate it.

The f_{GBW} of the whole system (frequency at which gain is 0 dB) which set responsiveness of the DC/DC converter can be calculated by getting DC gain and the first dimension pole by equations below. The responsiveness can be set high by setting the f_{GBW} to high frequency, but the whole system would be operated as bad oscillation if the f_{GBW} is set too high since there are not enough phase margin. The f_{GBW} must be equal to or lower than 1/5 of the switching frequency.

DC gain of the DC/DC converter can be expressed as below.

$$\text{DC gain (in step-down mode)} \quad DC \text{ gain} = \frac{A}{B} \times V_{REF} \times \frac{V_{IN}}{V_{OUT}} \quad (14)$$

$$\text{DC gain (in step-up mode)} \quad DC \text{ gain} = \frac{A}{B} \times V_{REF} \times \frac{V_{OUT}}{V_{OUT} - V_{IN}} \quad (15)$$

$$\text{DC gain (in buck-boost mode)} \quad DC \text{ gain} = \frac{A}{B} \times V_{REF} \times \frac{V_{IN} + V_{OUT}}{2DC \times V_{OUT}} \quad (16)$$

The DC gain of the DC/DC converter declines by 20dB/decade from the first dimension pole which is as shown below.

$$\text{The first dimension pole} \quad fp = \frac{1}{2\pi \times A \times \frac{R_1 R_2}{R_1 + R_2} \times C_2} \quad [Hz] \quad (17)$$

where:

A is the Error AMP gain=100dB=10⁵

B is the oscillator amplification=0.4V

V_{REF} is the reference voltage of Error AMP=0.5V

The f_{GBW} at 0 dB under limitation of the band width of the DC gain at the first dimension pole point is as shown below.

$$\text{Zero cross frequency} \quad f_{GBW} = DC \text{ gain} \times fp \quad [Hz] \quad (18)$$

I/O Equivalent Circuits

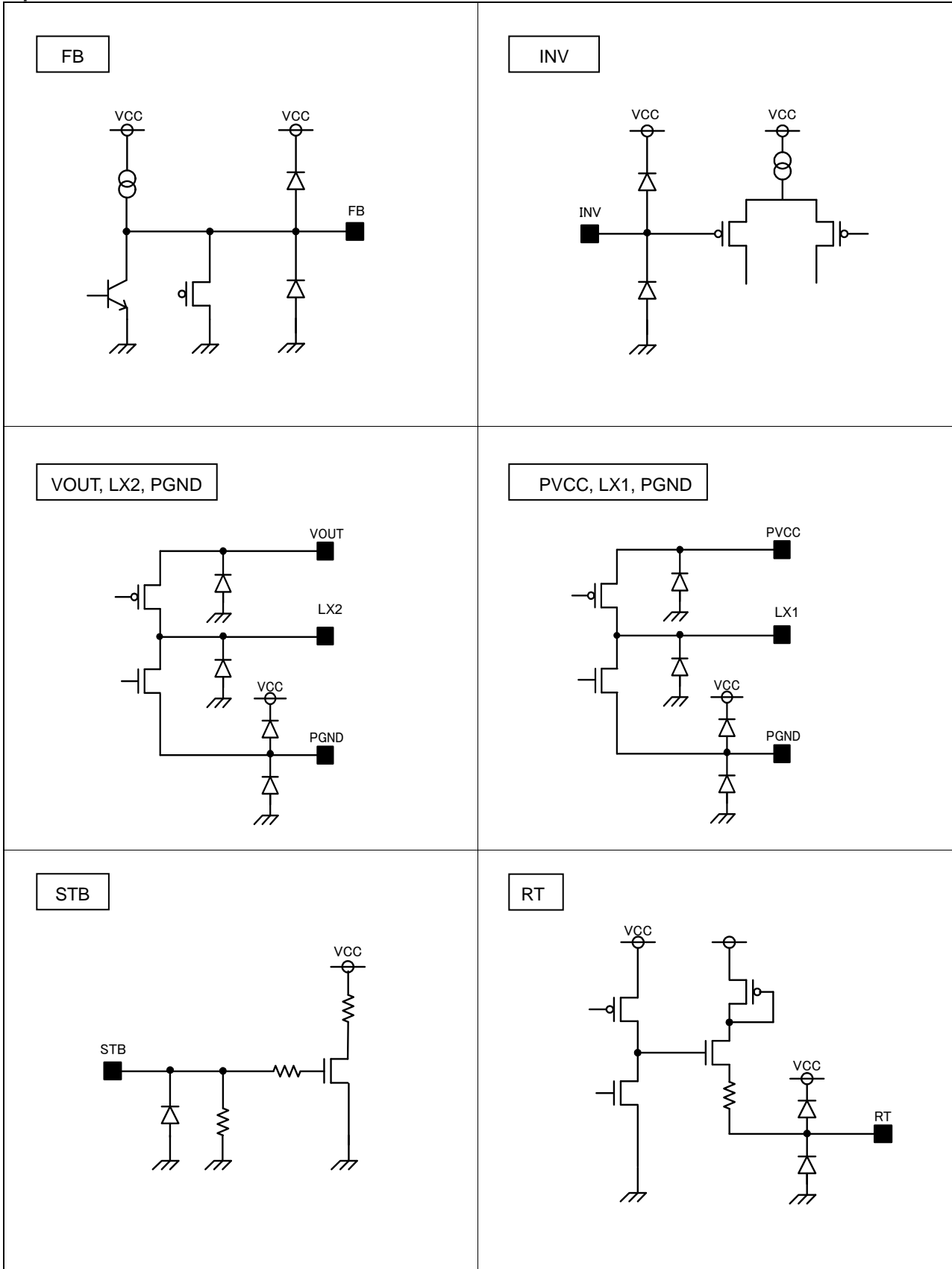

Operational Notes

1. Reverse Connection of Power Supply

Connecting the power supply in reverse polarity can damage the IC. Take precautions against reverse polarity when connecting the power supply, such as mounting an external diode between the power supply and the IC's power supply pins.

2. Power Supply Lines

Design the PCB layout pattern to provide low impedance supply lines. Separate the ground and supply lines of the digital and analog blocks to prevent noise in the ground and supply lines of the digital block from affecting the analog block. Furthermore, connect a capacitor to ground at all power supply pins. Consider the effect of temperature and aging on the capacitance value when using electrolytic capacitors.

3. Ground Voltage

Ensure that no pins are at a voltage below that of the ground pin at any time, even during transient condition.

4. Ground Wiring Pattern

When using both small-signal and large-current ground traces, the two ground traces should be routed separately but connected to a single ground at the reference point of the application board to avoid fluctuations in the small-signal ground caused by large currents. Also ensure that the ground traces of external components do not cause variations on the ground voltage. The ground lines must be as short and thick as possible to reduce line impedance.

5. Thermal Consideration

Should by any chance the power dissipation rating be exceeded the rise in temperature of the chip may result in deterioration of the properties of the chip. In case of exceeding this absolute maximum rating, increase the board size and copper area to prevent exceeding the Pd rating.

6. Recommended Operating Conditions

These conditions represent a range within which the expected characteristics of the IC can be approximately obtained. The electrical characteristics are guaranteed under the conditions of each parameter.

7. Inrush Current

When power is first supplied to the IC, it is possible that the internal logic may be unstable and inrush current may flow instantaneously due to the internal powering sequence and delays, especially if the IC has more than one power supply. Therefore, give special consideration to power coupling capacitance, power wiring, width of ground wiring, and routing of connections.

8. Operation Under Strong Electromagnetic Field

Operating the IC in the presence of a strong electromagnetic field may cause the IC to malfunction.

9. Testing on Application Boards

When testing the IC on an application board, connecting a capacitor directly to a low-impedance output pin may subject the IC to stress. Always discharge capacitors completely after each process or step. The IC's power supply should always be turned off completely before connecting or removing it from the test setup during the inspection process. To prevent damage from static discharge, ground the IC during assembly and use similar precautions during transport and storage.

10. Inter-pin Short and Mounting Errors

Ensure that the direction and position are correct when mounting the IC on the PCB. Incorrect mounting may result in damaging the IC. Avoid nearby pins being shorted to each other especially to ground, power supply and output pin. Inter-pin shorts could be due to many reasons such as metal particles, water droplets (in very humid environment) and unintentional solder bridge deposited in between pins during assembly to name a few.

Operational Notes – continued

11. Unused Input Pins

Input pins of an IC are often connected to the gate of a MOS transistor. The gate has extremely high impedance and extremely low capacitance. If left unconnected, the electric field from the outside can easily charge it. The small charge acquired in this way is enough to produce a significant effect on the conduction through the transistor and cause unexpected operation of the IC. So unless otherwise specified, unused input pins should be connected to the power supply or ground line.

12. Regarding the Input Pin of the IC

This monolithic IC contains P+ isolation and P substrate layers between adjacent elements in order to keep them isolated. P-N junctions are formed at the intersection of the P layers with the N layers of other elements, creating a parasitic diode or transistor. For example (refer to figure below):

When $GND > Pin A$ and $GND > Pin B$, the P-N junction operates as a parasitic diode.
When $GND > Pin B$, the P-N junction operates as a parasitic transistor.

Parasitic diodes inevitably occur in the structure of the IC. The operation of parasitic diodes can result in mutual interference among circuits, operational faults, or physical damage. Therefore, conditions that cause these diodes to operate, such as applying a voltage lower than the GND voltage to an input pin (and thus to the P substrate) should be avoided.

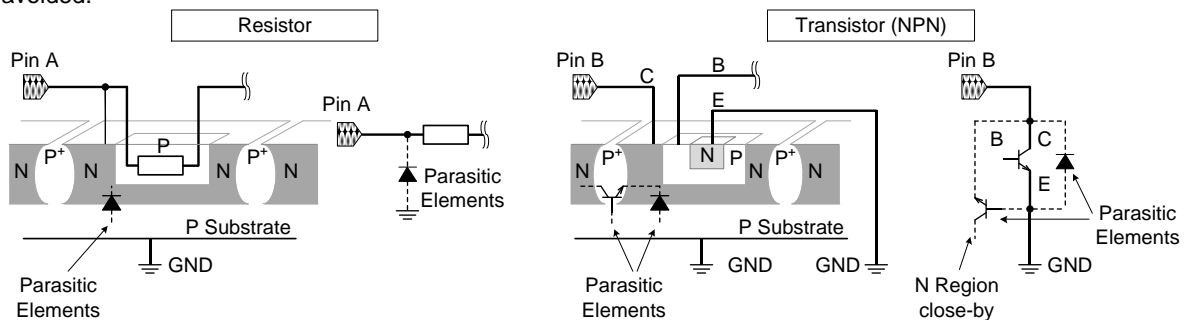

Figure 44. Example of monolithic IC structure

13. Thermal Shutdown Circuit(TSD)

This IC has a built-in thermal shutdown circuit that prevents heat damage to the IC. Normal operation should always be within the IC's power dissipation rating. If however the rating is exceeded for a continued period, the junction temperature (T_j) will rise which will activate the TSD circuit that will turn OFF all output pins. When the T_j falls below the TSD threshold, the circuits are automatically restored to normal operation.

Note that the TSD circuit operates in a situation that exceeds the absolute maximum ratings and therefore, under no circumstances, should the TSD circuit be used in a set design or for any purpose other than protecting the IC from heat damage.

Ordering Information

B D 8 3 0 6 M U V - E 2

Part Number

Package
MUV: VQFN016V3030

Packaging and forming specification
E2: Embossed tape and reel

Marking Diagram

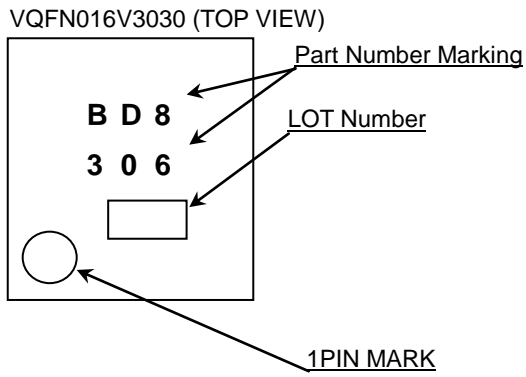

Physical Dimension, Tape and Reel Information

| | |
|--------------|--------------|
| Package Name | VQFN016V3030 |
|--------------|--------------|

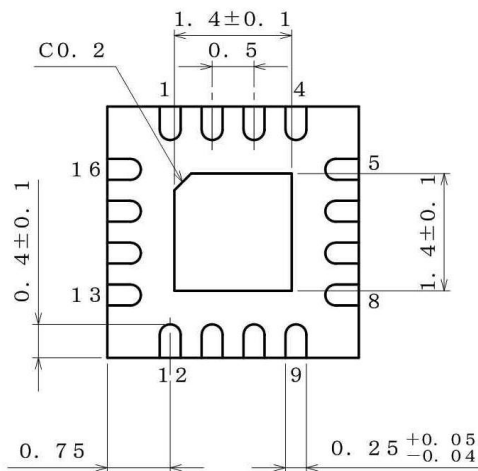
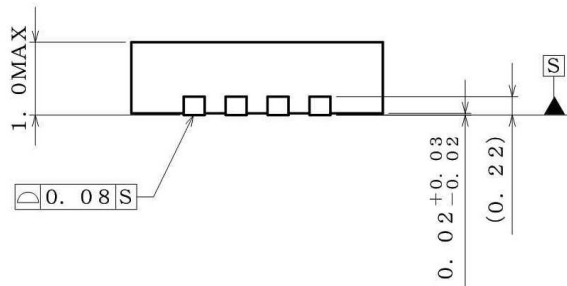
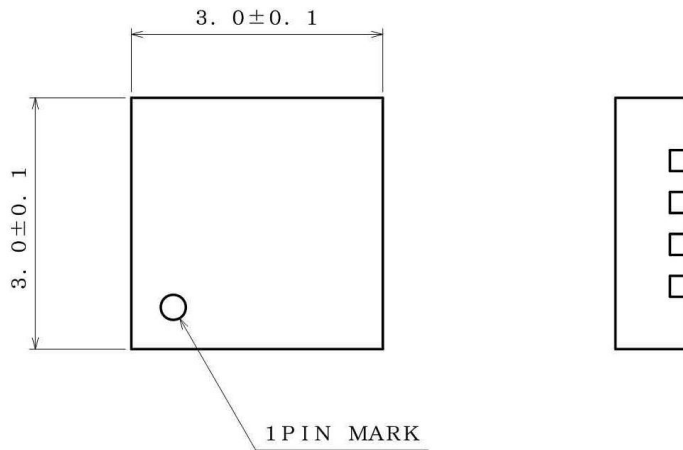

(UNIT : mm)

PKG : VQFN016V3030

Drawing No. EX460-5001-2

<Tape and Reel information>

| | |
|-------------------|---------------------------------------------------------------------------------------------------------------------------------------------------|
| Tape | Embossed carrier tape |
| Quantity | 3000pcs |
| Direction of feed | E2 (The direction is the 1pin of product is at the upper left when you hold reel on the left hand and you pull out the tape on the right hand) |

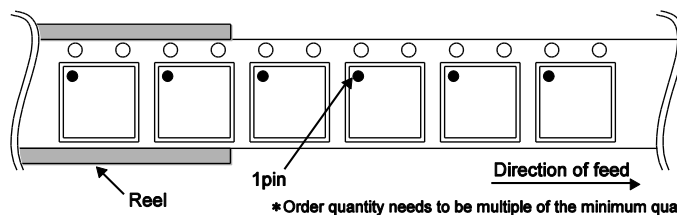

Revision History

| Date | Revision | Changes |
|-------------|----------|----------------------------|
| 26.Nov.2014 | 001 | New Release |
| 17.Feb.2015 | 002 | Correction of the writing. |

Notice

Precaution on using ROHM Products

- Our Products are designed and manufactured for application in ordinary electronic equipments (such as AV equipment, OA equipment, telecommunication equipment, home electronic appliances, amusement equipment, etc.). If you intend to use our Products in devices requiring extremely high reliability (such as medical equipment ^(Note 1), transport equipment, traffic equipment, aircraft/spacecraft, nuclear power controllers, fuel controllers, car equipment including car accessories, safety devices, etc.) and whose malfunction or failure may cause loss of human life, bodily injury or serious damage to property ("Specific Applications"), please consult with the ROHM sales representative in advance. Unless otherwise agreed in writing by ROHM in advance, ROHM shall not be in any way responsible or liable for any damages, expenses or losses incurred by you or third parties arising from the use of any ROHM's Products for Specific Applications.

(Note1) Medical Equipment Classification of the Specific Applications

| JAPAN | USA | EU | CHINA |
|-----------|-----------|------------|-----------|
| CLASS III | CLASS III | CLASS II b | CLASS III |
| CLASS IV | | CLASS III | |

- ROHM designs and manufactures its Products subject to strict quality control system. However, semiconductor products can fail or malfunction at a certain rate. Please be sure to implement, at your own responsibilities, adequate safety measures including but not limited to fail-safe design against the physical injury, damage to any property, which a failure or malfunction of our Products may cause. The following are examples of safety measures:
 - Installation of protection circuits or other protective devices to improve system safety
 - Installation of redundant circuits to reduce the impact of single or multiple circuit failure
- Our Products are designed and manufactured for use under standard conditions and not under any special or extraordinary environments or conditions, as exemplified below. Accordingly, ROHM shall not be in any way responsible or liable for any damages, expenses or losses arising from the use of any ROHM's Products under any special or extraordinary environments or conditions. If you intend to use our Products under any special or extraordinary environments or conditions (as exemplified below), your independent verification and confirmation of product performance, reliability, etc. prior to use, must be necessary:
 - Use of our Products in any types of liquid, including water, oils, chemicals, and organic solvents
 - Use of our Products outdoors or in places where the Products are exposed to direct sunlight or dust
 - Use of our Products in places where the Products are exposed to sea wind or corrosive gases, including Cl₂, H₂S, NH₃, SO₂, and NO₂
 - Use of our Products in places where the Products are exposed to static electricity or electromagnetic waves
 - Use of our Products in proximity to heat-producing components, plastic cords, or other flammable items
 - Sealing or coating our Products with resin or other coating materials
 - Use of our Products without cleaning residue of flux (even if you use no-clean type fluxes, cleaning residue of flux is recommended); or Washing our Products by using water or water-soluble cleaning agents for cleaning residue after soldering
 - Use of the Products in places subject to dew condensation
- The Products are not subject to radiation-proof design.
- Please verify and confirm characteristics of the final or mounted products in using the Products.
- In particular, if a transient load (a large amount of load applied in a short period of time, such as pulse. is applied, confirmation of performance characteristics after on-board mounting is strongly recommended. Avoid applying power exceeding normal rated power; exceeding the power rating under steady-state loading condition may negatively affect product performance and reliability.
- De-rate Power Dissipation depending on ambient temperature. When used in sealed area, confirm that it is the use in the range that does not exceed the maximum junction temperature.
- Confirm that operation temperature is within the specified range described in the product specification.
- ROHM shall not be in any way responsible or liable for failure induced under deviant condition from what is defined in this document.

Precaution for Mounting / Circuit board design

- When a highly active halogenous (chlorine, bromine, etc.) flux is used, the residue of flux may negatively affect product performance and reliability.
- In principle, the reflow soldering method must be used on a surface-mount products, the flow soldering method must be used on a through hole mount products. If the flow soldering method is preferred on a surface-mount products, please consult with the ROHM representative in advance.

For details, please refer to ROHM Mounting specification

Precautions Regarding Application Examples and External Circuits

1. If change is made to the constant of an external circuit, please allow a sufficient margin considering variations of the characteristics of the Products and external components, including transient characteristics, as well as static characteristics.
2. You agree that application notes, reference designs, and associated data and information contained in this document are presented only as guidance for Products use. Therefore, in case you use such information, you are solely responsible for it and you must exercise your own independent verification and judgment in the use of such information contained in this document. ROHM shall not be in any way responsible or liable for any damages, expenses or losses incurred by you or third parties arising from the use of such information.

Precaution for Electrostatic

This Product is electrostatic sensitive product, which may be damaged due to electrostatic discharge. Please take proper caution in your manufacturing process and storage so that voltage exceeding the Products maximum rating will not be applied to Products. Please take special care under dry condition (e.g. Grounding of human body / equipment / solder iron, isolation from charged objects, setting of Ionizer, friction prevention and temperature / humidity control).

Precaution for Storage / Transportation

1. Product performance and soldered connections may deteriorate if the Products are stored in the places where:
 - [a] the Products are exposed to sea winds or corrosive gases, including Cl₂, H₂S, NH₃, SO₂, and NO₂
 - [b] the temperature or humidity exceeds those recommended by ROHM
 - [c] the Products are exposed to direct sunshine or condensation
 - [d] the Products are exposed to high Electrostatic
2. Even under ROHM recommended storage condition, solderability of products out of recommended storage time period may be degraded. It is strongly recommended to confirm solderability before using Products of which storage time is exceeding the recommended storage time period.
3. Store / transport cartons in the correct direction, which is indicated on a carton with a symbol. Otherwise bent leads may occur due to excessive stress applied when dropping of a carton.
4. Use Products within the specified time after opening a humidity barrier bag. Baking is required before using Products of which storage time is exceeding the recommended storage time period.

Precaution for Product Label

A two-dimensional barcode printed on ROHM Products label is for ROHM's internal use only.

Precaution for Disposition

When disposing Products please dispose them properly using an authorized industry waste company.

Precaution for Foreign Exchange and Foreign Trade act

Since concerned goods might be fallen under listed items of export control prescribed by Foreign exchange and Foreign trade act, please consult with ROHM in case of export.

Precaution Regarding Intellectual Property Rights

1. All information and data including but not limited to application example contained in this document is for reference only. ROHM does not warrant that foregoing information or data will not infringe any intellectual property rights or any other rights of any third party regarding such information or data.
2. ROHM shall not have any obligations where the claims, actions or demands arising from the combination of the Products with other articles such as components, circuits, systems or external equipment (including software).
3. No license, expressly or implied, is granted hereby under any intellectual property rights or other rights of ROHM or any third parties with respect to the Products or the information contained in this document. Provided, however, that ROHM will not assert its intellectual property rights or other rights against you or your customers to the extent necessary to manufacture or sell products containing the Products, subject to the terms and conditions herein.

Other Precaution

1. This document may not be reprinted or reproduced, in whole or in part, without prior written consent of ROHM.
2. The Products may not be disassembled, converted, modified, reproduced or otherwise changed without prior written consent of ROHM.
3. In no event shall you use in any way whatsoever the Products and the related technical information contained in the Products or this document for any military purposes, including but not limited to, the development of mass-destruction weapons.
4. The proper names of companies or products described in this document are trademarks or registered trademarks of ROHM, its affiliated companies or third parties.

General Precaution

1. Before you use our Products, you are requested to carefully read this document and fully understand its contents. ROHM shall not be in any way responsible or liable for failure, malfunction or accident arising from the use of any ROHM's Products against warning, caution or note contained in this document.
2. All information contained in this document is current as of the issuing date and subject to change without any prior notice. Before purchasing or using ROHM's Products, please confirm the latest information with a ROHM sales representative.
3. The information contained in this document is provided on an "as is" basis and ROHM does not warrant that all information contained in this document is accurate and/or error-free. ROHM shall not be in any way responsible or liable for any damages, expenses or losses incurred by you or third parties resulting from inaccuracy or errors of or concerning such information.

Mouser Electronics

Authorized Distributor

Click to View Pricing, Inventory, Delivery & Lifecycle Information:

[ROHM Semiconductor:](#)

[BD8306MUV-E2](#)