

N-Channel 20 V (D-S) 175 °C MOSFET

PRODUCT SUMMARY

V_{DS} (V)	$R_{DS(on)}$ (Ω)	I_D (A) ^a
20	0.0060 at $V_{GS} = 10$ V	26
	0.0095 at $V_{GS} = 4.5$ V	21

FEATURES

- TrenchFET[®] Power MOSFET
- 175 °C Junction Temperature
- PWM Optimized for High Efficiency
- 100 % R_g Tested
- Compliant to RoHS Directive 2002/95/EC



RoHS
COMPLIANT

APPLICATIONS

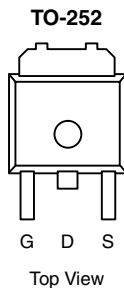
- Synchronous Buck DC/DC Conversion
 - Desktop
 - Server

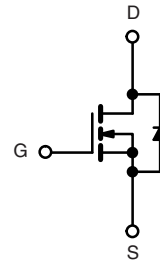

Drain Connected to Tab

Ordering Information: SUD50N02-06P-E3 (Lead (Pb) free)

N-Channel MOSFET

ABSOLUTE MAXIMUM RATINGS ($T_A = 25$ °C, unless otherwise noted)

Parameter	Symbol	Limit	Unit	
Drain-Source Voltage	V_{DS}	20	V	
Gate-Source Voltage	V_{GS}	± 20		
Continuous Drain Current ^a	I_D	$T_A = 25$ °C	26 ^a	A
		$T_C = 25$ °C	50 ^b	
Pulsed Drain Current	I_{DM}	100		
Continuous Source Current (Diode Conduction) ^a	I_S	26		
Avalanche Current	I_{AS}	L = 0.1 mH	45	
Single Pulse Avalanche Energy			E_{AS}	101
Maximum Power Dissipation	P_D	$T_A = 25$ °C	6.8 ^a	W
		$T_C = 25$ °C	65	
Operating Junction and Storage Temperature Range	T_J, T_{stg}	- 55 to 175	°C	

THERMAL RESISTANCE RATINGS

Parameter	Symbol	Typical	Maximum	Unit	
Maximum Junction-to-Ambient ^a	R_{thJA}	$t \leq 10$ s	18	22	°C/W
		Steady State	40	50	
Maximum Junction-to-Case	R_{thJC}	1.9	2.3		

Notes:

 a. Surface mounted on FR4 board, $t \leq 10$ s.

b. Limited by package.



SPECIFICATIONS (T _J = 25 °C, unless otherwise noted)						
Parameter	Symbol	Test Conditions	Min.	Typ. ^a	Max.	Unit
Static						
Drain-Source Breakdown Voltage	V _{DS}	V _{GS} = 0 V, I _D = 250 μA	20			V
Gate Threshold Voltage	V _{GS(th)}	V _{DS} = V _{GS} , I _D = 250 μA	0.8		3	V
Gate-Body Leakage	I _{GSS}	V _{DS} = 0 V, V _{GS} = ± 20 V			± 100	nA
Zero Gate Voltage Drain Current	I _{DSS}	V _{DS} = 20 V, V _{GS} = 0 V			1	μA
		V _{DS} = 20 V, V _{GS} = 0 V, T _J = 125 °C			50	
On-State Drain Current ^b	I _{D(on)}	V _{DS} = 5 V, V _{GS} = 10 V	50			A
Drain-Source On-State Resistance ^b	r _{DS(on)}	V _{GS} = 10 V, I _D = 20 A		0.0046	0.006	Ω
		V _{GS} = 10 V, I _D = 20 A, T _J = 125 °C			0.0084	
		V _{GS} = 4.5 V, I _D = 20 A		0.0073	0.0095	
Forward Transconductance ^b	g _{fs}	V _{DS} = 15 V, I _D = 20 A	15			S
Dynamic^a						
Input Capacitance	C _{iss}	V _{GS} = 0 V, V _{DS} = 10 V, f = 1 MHz		2550		pF
Output Capacitance	C _{oss}			900		
Reverse Transfer Capacitance	C _{rss}			415		
Total Gate Charge ^c	Q _g	V _{DS} = 10 V, V _{GS} = 4.5 V, I _D = 50 A		19	30	nC
Gate-Source Charge ^c	Q _{gs}			7.5		
Gate-Drain Charge ^c	Q _{gd}			6		
Gate Resistance	R _g		0.5	1.5	2.4	Ω
Turn-On Delay Time ^c	t _{d(on)}	V _{DD} = 10 V, R _L = 0.2 Ω I _D ≅ 50 A, V _{GEN} = 10 V, R _G = 2.5 Ω		11	20	ns
Rise Time ^c	t _r			10	15	
Turn-Off Delay Time ^c	t _{d(off)}			24	35	
Fall Time ^c	t _f			9	15	
Source-Drain Diode Ratings and Characteristic (T_C = 25 °C)						
Pulsed Current	I _{SM}				100	A
Diode Forward Voltage ^b	V _{SD}	I _F = 50 A, V _{GS} = 0 V		1.2	1.5	V
Source-Drain Reverse Recovery Time	t _{rr}	I _F = 50 A, di/dt = 100 A/μs		35	70	ns

Notes:

- a. Guaranteed by design, not subject to production testing.
- b. Pulse test; pulse width ≤ 300 μs, duty cycle ≤ 2 %.
- c. Independent of operating temperature.

Stresses beyond those listed under "Absolute Maximum Ratings" may cause permanent damage to the device. These are stress ratings only, and functional operation of the device at these or any other conditions beyond those indicated in the operational sections of the specifications is not implied. Exposure to absolute maximum rating conditions for extended periods may affect device reliability.

TYPICAL CHARACTERISTICS (25 °C unless noted)

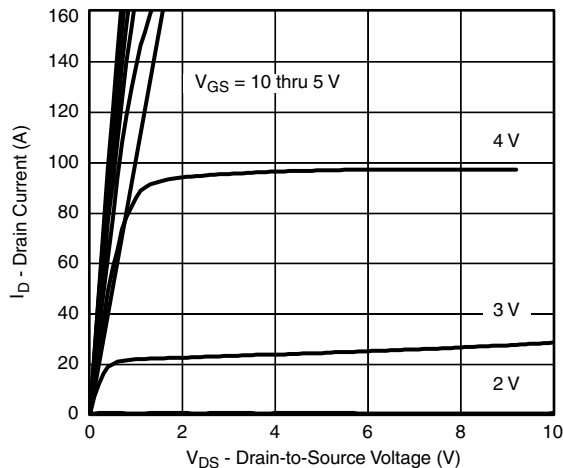

Output Characteristics

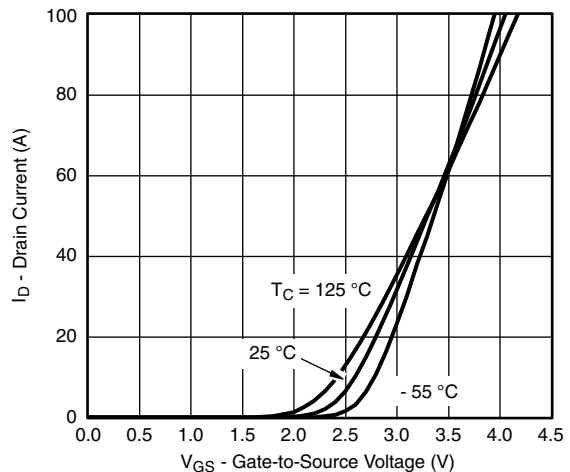

Transfer Characteristics

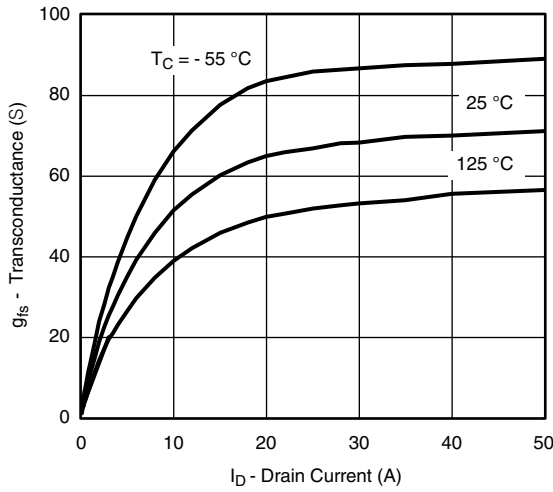
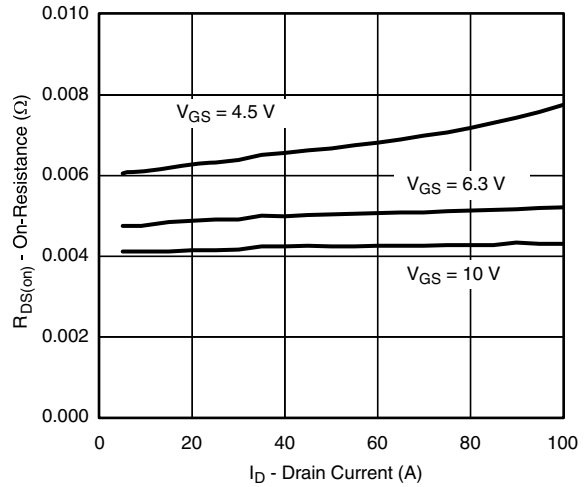
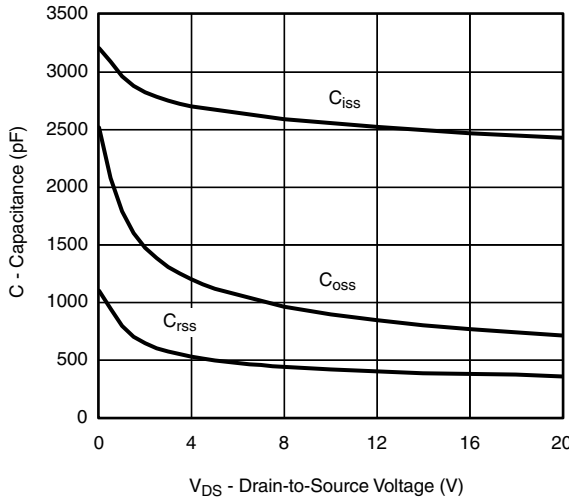
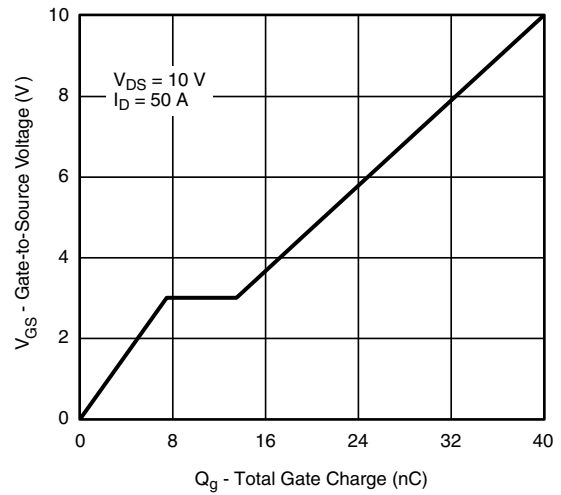
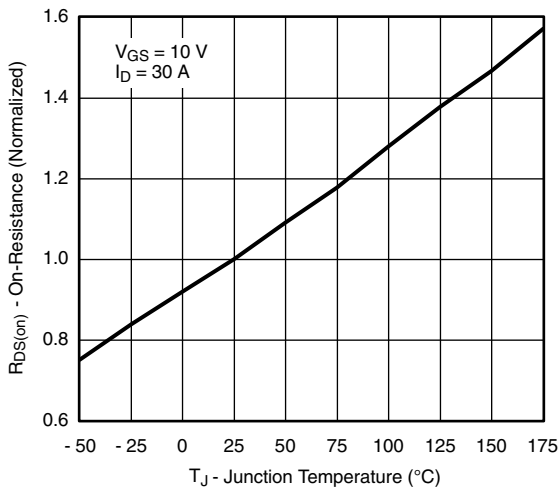
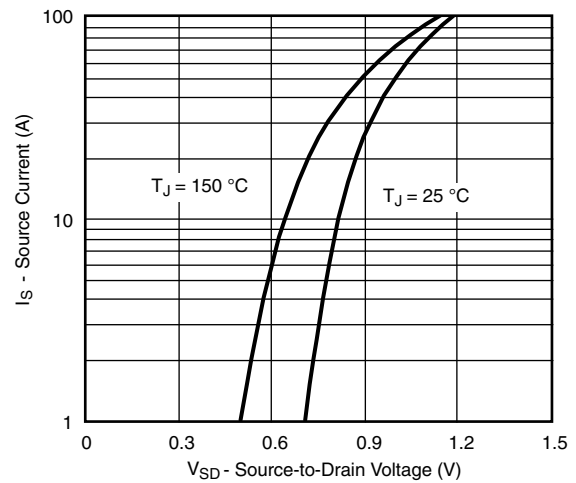
TYPICAL CHARACTERISTICS (25 °C unless noted)

Transconductance

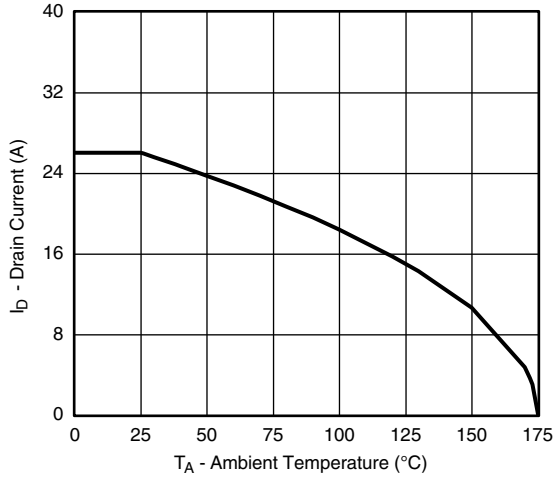
On-Resistance vs. Drain Current

Capacitance

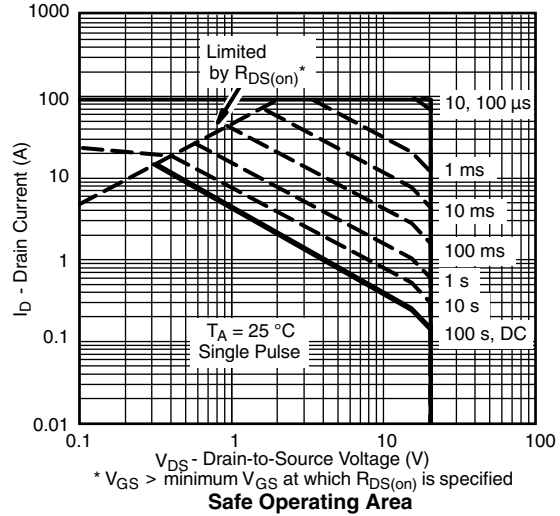
Gate Charge

On-Resistance vs. Junction Temperature

Source-Drain Diode Forward Voltage

THERMAL RATINGS



Maximum Drain Current vs. Ambient Temperature



Safe Operating Area

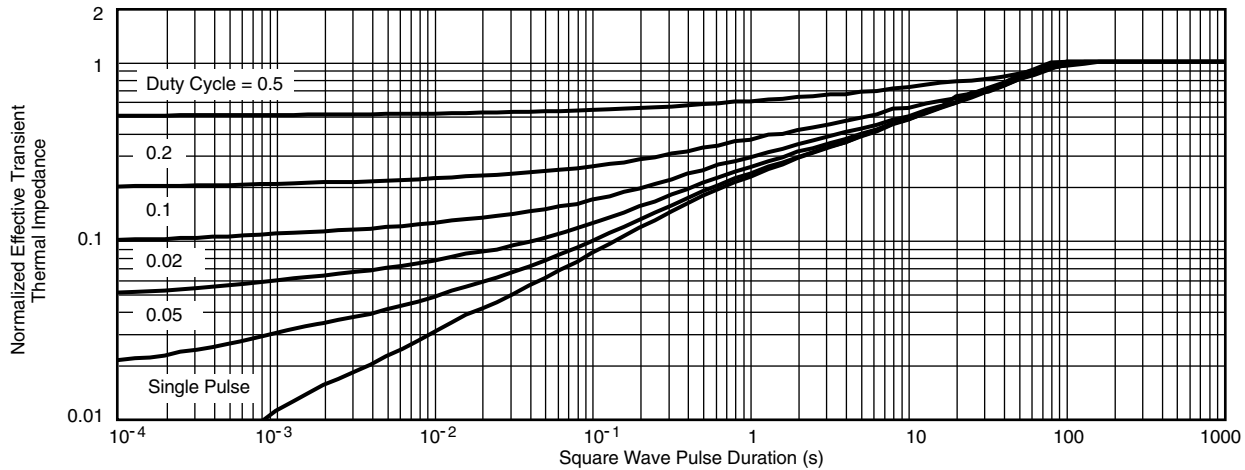

Normalized Thermal Transient Impedance, Junction-to-Ambient

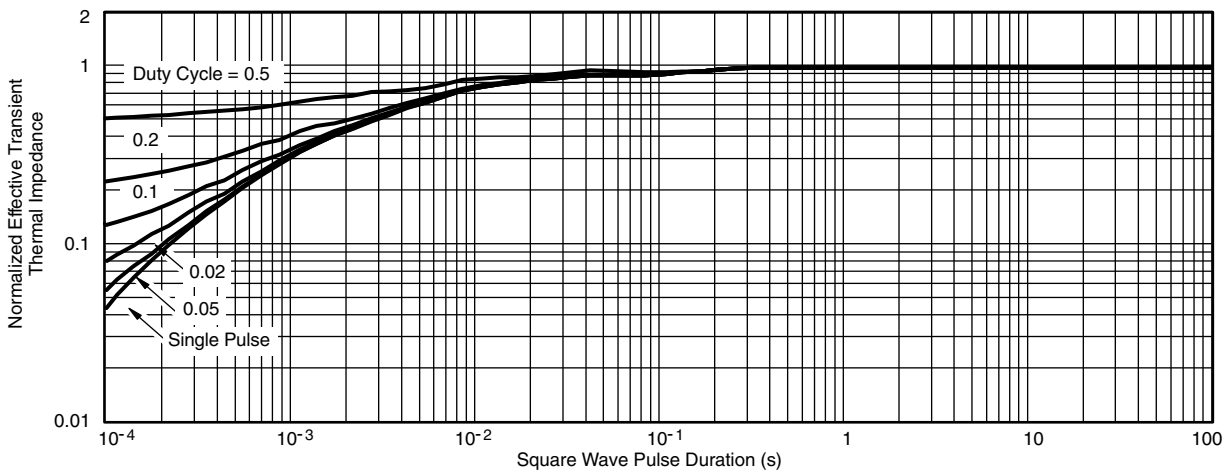

Normalized Thermal Transient Impedance, Junction-to-Case

Vishay Siliconix maintains worldwide manufacturing capability. Products may be manufactured at one of several qualified locations. Reliability data for Silicon Technology and Package Reliability represent a composite of all qualified locations. For related documents such as package/tape drawings, part marking, and reliability data, see www.vishay.com/ppg?71931.



TO-252AA Case Outline

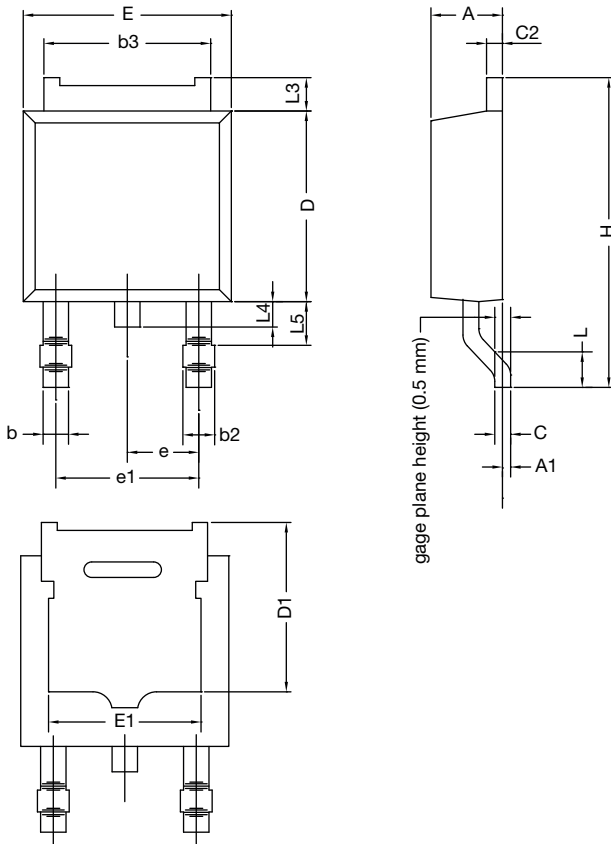

DIM.	MILLIMETERS		INCHES	
	MIN.	MAX.	MIN.	MAX.
A	2.18	2.38	0.086	0.094
A1	-	0.127	-	0.005
b	0.64	0.88	0.025	0.035
b2	0.76	1.14	0.030	0.045
b3	4.95	5.46	0.195	0.215
C	0.46	0.61	0.018	0.024
C2	0.46	0.89	0.018	0.035
D	5.97	6.22	0.235	0.245
D1	4.10	-	0.161	-
E	6.35	6.73	0.250	0.265
E1	4.32	-	0.170	-
H	9.40	10.41	0.370	0.410
e	2.28 BSC		0.090 BSC	
e1	4.56 BSC		0.180 BSC	
L	1.40	1.78	0.055	0.070
L3	0.89	1.27	0.035	0.050
L4	-	1.02	-	0.040
L5	1.01	1.52	0.040	0.060
ECN: T16-0236-Rev. P, 16-May-16 DWG: 5347				

Notes

- Dimension L3 is for reference only.

RECOMMENDED MINIMUM PADS FOR DPAK (TO-252)

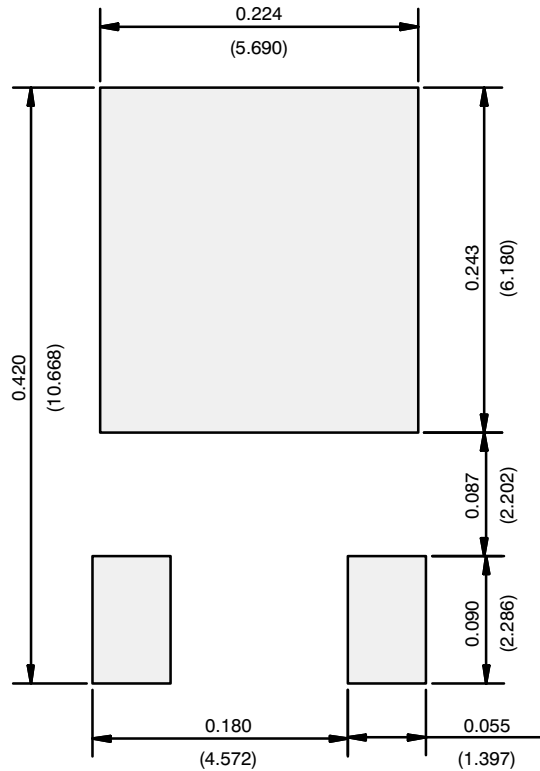

Recommended Minimum Pads
Dimensions in Inches/(mm)

[Return to Index](#)



Disclaimer

ALL PRODUCT, PRODUCT SPECIFICATIONS AND DATA ARE SUBJECT TO CHANGE WITHOUT NOTICE TO IMPROVE RELIABILITY, FUNCTION OR DESIGN OR OTHERWISE.

Vishay Intertechnology, Inc., its affiliates, agents, and employees, and all persons acting on its or their behalf (collectively, "Vishay"), disclaim any and all liability for any errors, inaccuracies or incompleteness contained in any datasheet or in any other disclosure relating to any product.

Vishay makes no warranty, representation or guarantee regarding the suitability of the products for any particular purpose or the continuing production of any product. To the maximum extent permitted by applicable law, Vishay disclaims (i) any and all liability arising out of the application or use of any product, (ii) any and all liability, including without limitation special, consequential or incidental damages, and (iii) any and all implied warranties, including warranties of fitness for particular purpose, non-infringement and merchantability.

Statements regarding the suitability of products for certain types of applications are based on Vishay's knowledge of typical requirements that are often placed on Vishay products in generic applications. Such statements are not binding statements about the suitability of products for a particular application. It is the customer's responsibility to validate that a particular product with the properties described in the product specification is suitable for use in a particular application. Parameters provided in datasheets and / or specifications may vary in different applications and performance may vary over time. All operating parameters, including typical parameters, must be validated for each customer application by the customer's technical experts. Product specifications do not expand or otherwise modify Vishay's terms and conditions of purchase, including but not limited to the warranty expressed therein.

Except as expressly indicated in writing, Vishay products are not designed for use in medical, life-saving, or life-sustaining applications or for any other application in which the failure of the Vishay product could result in personal injury or death. Customers using or selling Vishay products not expressly indicated for use in such applications do so at their own risk. Please contact authorized Vishay personnel to obtain written terms and conditions regarding products designed for such applications.

No license, express or implied, by estoppel or otherwise, to any intellectual property rights is granted by this document or by any conduct of Vishay. Product names and markings noted herein may be trademarks of their respective owners.