

PART
NAME

VALU/LINE SERIES CABINET

PART
No.

NHC-14157

REVISION
DATE

11-1-07

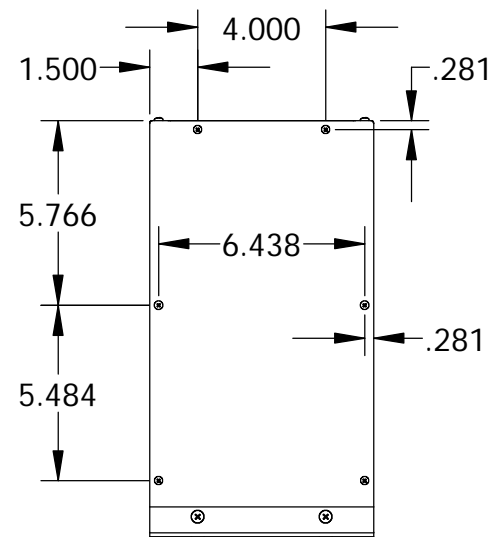
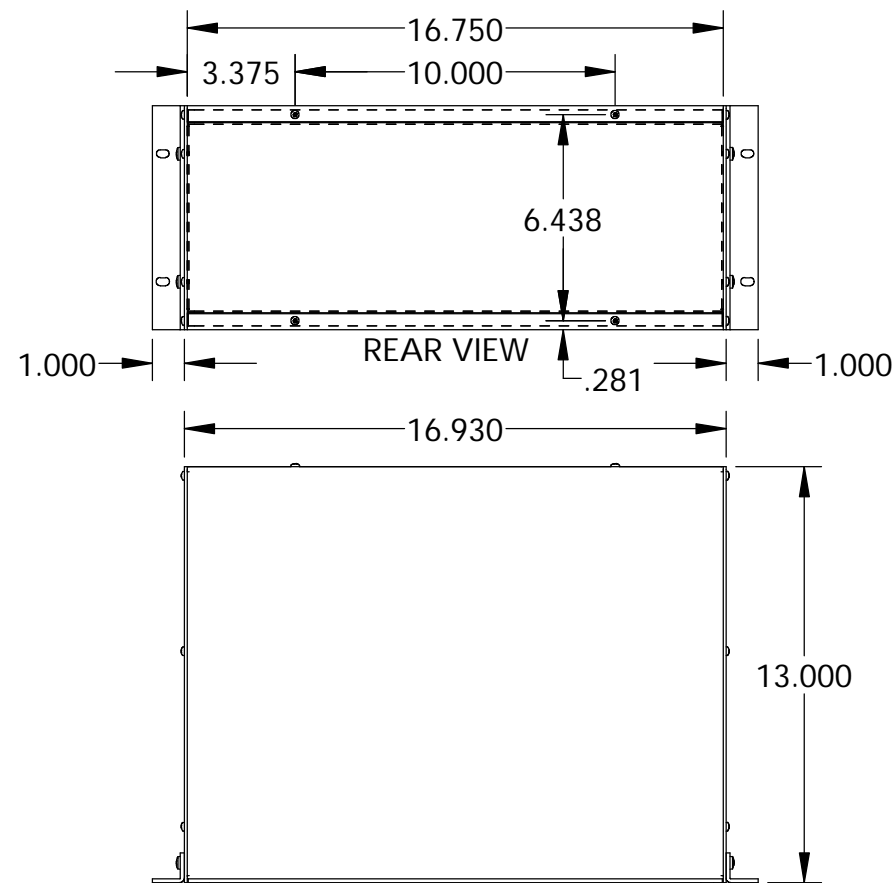

MATERIAL:

BACK & COVERS _____ 0.050 THICK ALUMINUM
 SIDES & INNER BRACKETS ____ 0.090 THICK ALUMINUM
 FRONT PANEL _____ 0.125 THICK ALUMINUM
 OUTER BRACKETS _____ 11 GA. C.R.S.

FINISH:

BACK & COVERS _____ PREPAINTED SMOOTH WHITE
 SIDES & OUTER BRACKETS ____ WHITE TEXTURED
 FRONT PANEL _____ NATURAL (OUTSIDE SURFACE TAPED WITH PVC)
 INNER BRACKETS _____ NATURAL
 FEET _____ BLACK

UNIT SHIPPED UNASSEMBLED.

OUTER BRACKETS FOR MOUNTING IN
STANDARD 19" WIDE CABINETS.

OPTIONAL SELF-ADHESIVE RUBBER FEET (SUPPLIED)

LOAD RATING: 25 LBS. MAX.

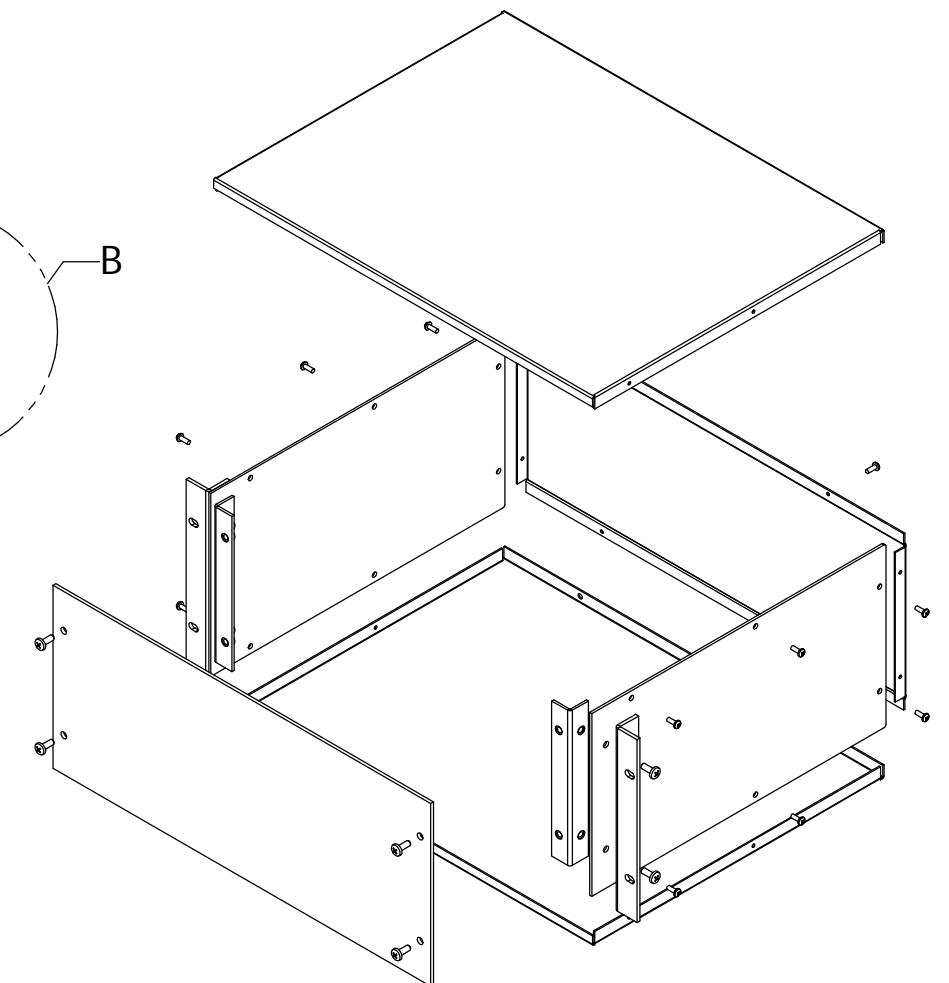
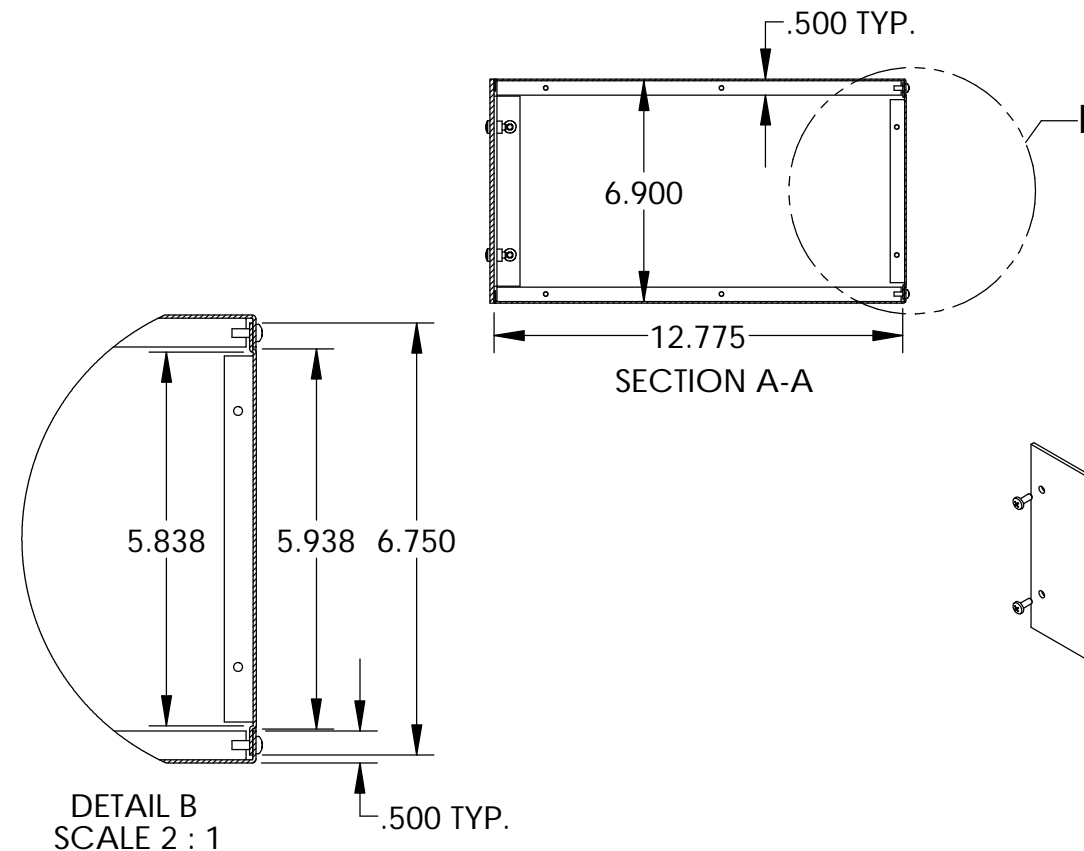
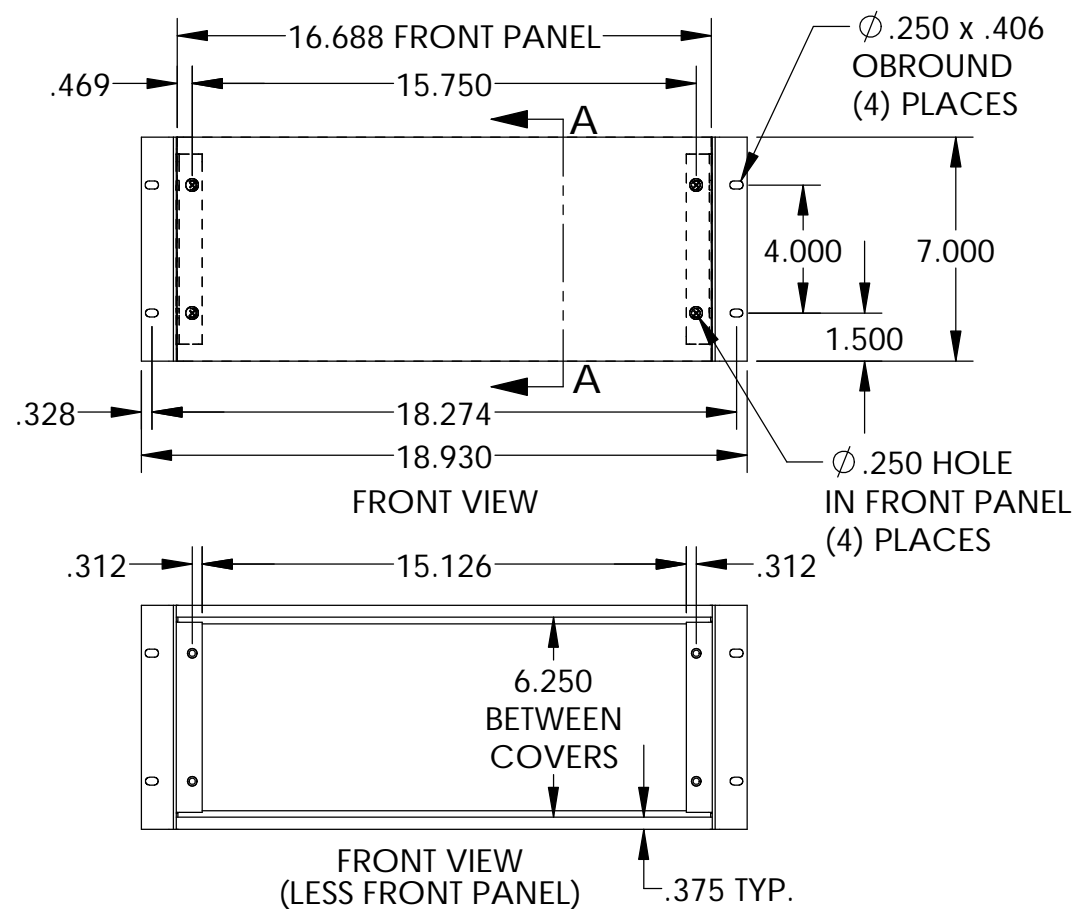

Mouser Electronics

Authorized Distributor

Click to View Pricing, Inventory, Delivery & Lifecycle Information:

[Bud Industries:](#)

[NHC-14157](#)