

# PNP Silicon Transistor

## KSA1156

### Features

- High Breakdown Voltage
- Low Collector Saturation Voltage
- High Speed Switching
- This is a Pb-Free Device

### Applications

- High Voltage Switching
- Low Power Switching Regulator
- DC-DC Converter

### ABSOLUTE MAXIMUM RATINGS (T<sub>C</sub> = 25°C unless otherwise noted)

Symbol	Parameter	Ratings	Units
V <sub>CB0</sub>	Collector-Base Voltage	-400	V
V <sub>CEO</sub>	Collector-Emitter Voltage	-400	V
V <sub>EB0</sub>	Emitter-Base Voltage	-7	V
I <sub>B</sub>	Base Current	-0.25	A
I <sub>C</sub>	Collector Current (DC)	-0.5	A
I <sub>CP</sub>	Collector Current (Pulse)	-1	A
P <sub>C</sub>	Collector Dissipation, T <sub>A</sub> = 25°C T <sub>C</sub> = 25°C	1 10	W
T <sub>J</sub>	Junction Temperature	150	°C
T <sub>STG</sub>	Storage Temperature	-55 ~ 150	°C

Stresses exceeding those listed in the Maximum Ratings table may damage the device. If any of these limits are exceeded, device functionality should not be assumed, damage may occur and reliability may be affected.

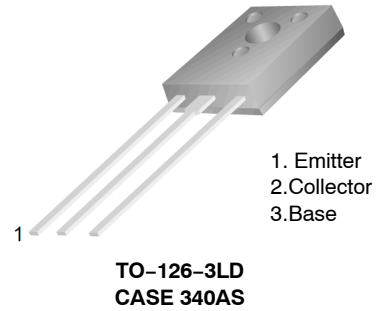

### MARKING DIAGRAM

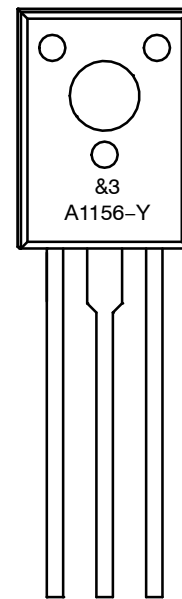

&3 = 3-Digit Date Code  
A1156-Y = Specific Device Code

### ORDERING INFORMATION

Device	Package	Shipping
KSA1156YS	TO-126-3LD (Pb-Free)	2000 Units / Bulk Bag

# KSA1156

## ELECTRICAL CHARACTERISTICS ( $T_C = 25^\circ\text{C}$ unless otherwise noted)

Symbol	Characteristic	Test Condition	Min	Max	Unit
$V_{CE0(sus)}$	Collector-Emitter Sustaining Voltage	$I_C = -100\text{ mA}, I_B = -10\text{ mA}, L = -20\text{ mH}$	-400	-	V
$V_{CEX(sus)}$	Collector-Emitter Sustaining Voltage	$I_C = -200\text{ mA}, I_{B1} = I_{B2} = -20\text{ mA}, V_{BE(off)} = 5\text{ V}, L = 10\text{ mH}$	-400	-	V
$I_{CBO}$	Collector Cut-off Current	$V_{CB} = -400\text{ V}, I_E = 0$	-	-100	$\mu\text{A}$
$I_{EBO}$	Emitter Cut-off Current	$V_{EB} = -5\text{ V}, I_C = 0$	-	-10	$\mu\text{A}$
$I_{CEX1}$	Collector Cut-off Current	$V_{CE} = -400\text{ V}, V_{BE(off)} = 1.5\text{ V}$	-	-100	$\mu\text{A}$
$I_{CEX2}$	Collector Cut-off Current	$V_{CE} = -400\text{ V}, V_{BE(off)} = 1.5\text{ V}, T_C = 125^\circ\text{C}$	-	-1	mA
$h_{FE}$	DC Current Gain	$V_{CE} = -5\text{ V}, I_C = -100\text{ mA}$	30	200	
$V_{CE(sat)}$	Collector-Emitter Saturation Voltage	$I_C = -100\text{ mA}, I_B = -10\text{ mA}$	-	-1	V
$V_{BE(sat)}$	Base-Emitter Saturation Voltage	$I_C = -100\text{ mA}, I_B = -10\text{ mA}$	-	-1.2	V
$t_{ON}$	Turn On Time	$V_{CC} = -150\text{ V}, I_C = -100\text{ mA}, I_{B1} = -10\text{ mA}, I_{B2} = 20\text{ mA}, R_L = 1.5\text{ k}\Omega$	-	1	$\mu\text{s}$
$t_{STG}$	Storage Time		-	4	$\mu\text{s}$
$t_F$	Fall Time		-	1	$\mu\text{s}$

Product parametric performance is indicated in the Electrical Characteristics for the listed test conditions, unless otherwise noted. Product performance may not be indicated by the Electrical Characteristics if operated under different conditions.

## $h_{FE}$ CLASSIFICATION

Classification	N	R	O	Y
$h_{FE}$	30 ~ 60	40 ~ 80	60 ~ 120	100 ~ 200

TYPICAL CHARACTERISTICS

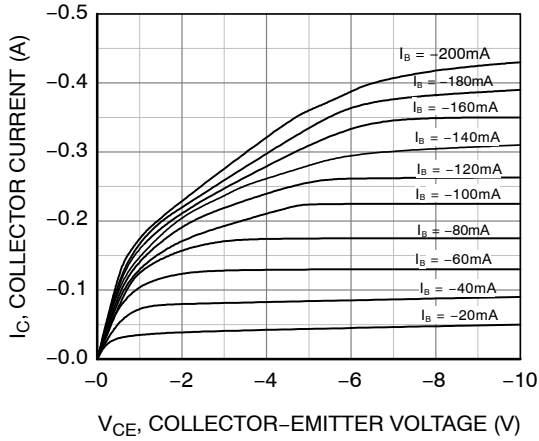

Figure 1. Static Characteristic

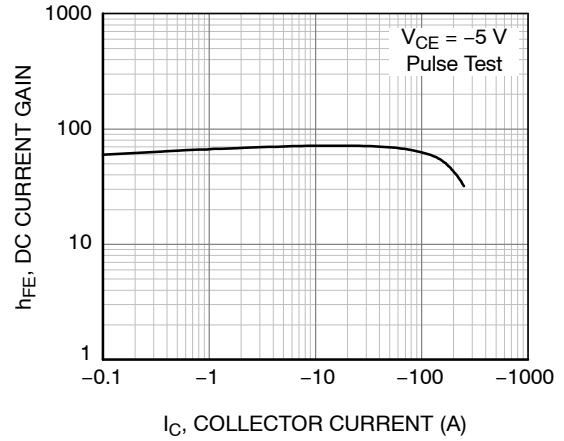

Figure 2. DC Current Gain

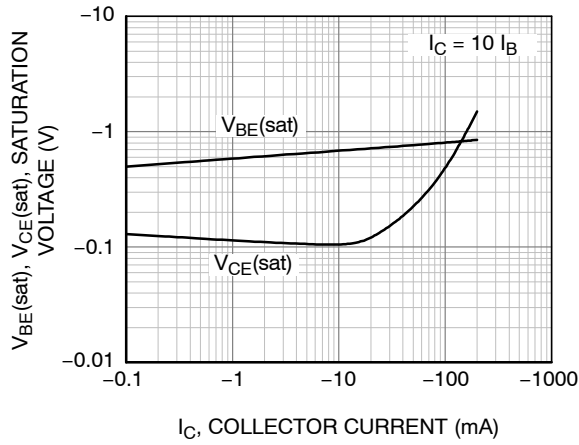

Figure 3. Collector-Emitter Saturation Voltage  
Base-Emitter Saturation Voltage

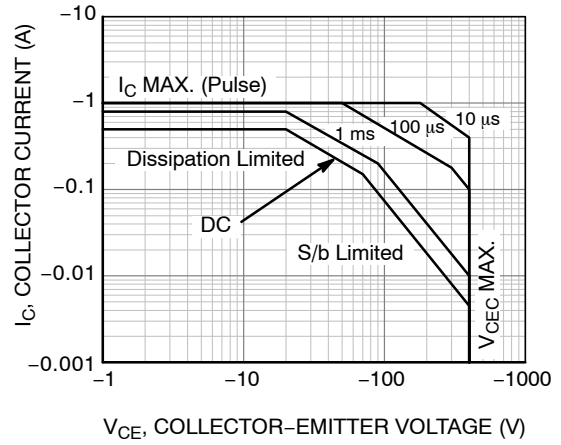

Figure 4. Safe Operating Area

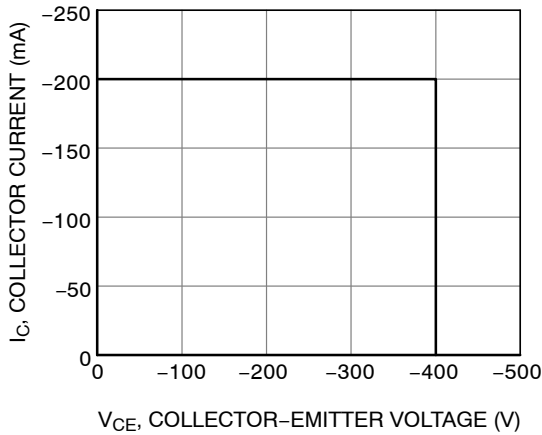

Figure 5. Reverse Bias Safe Operating Area

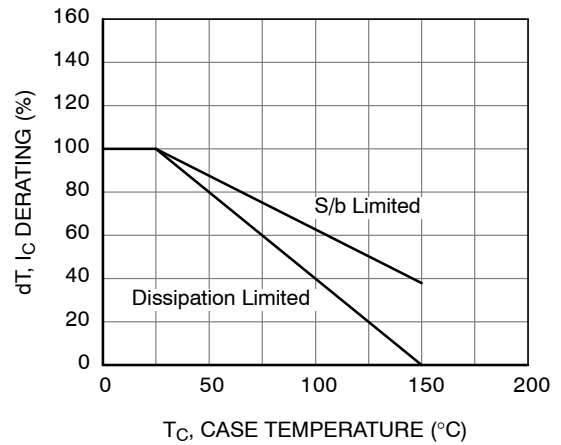
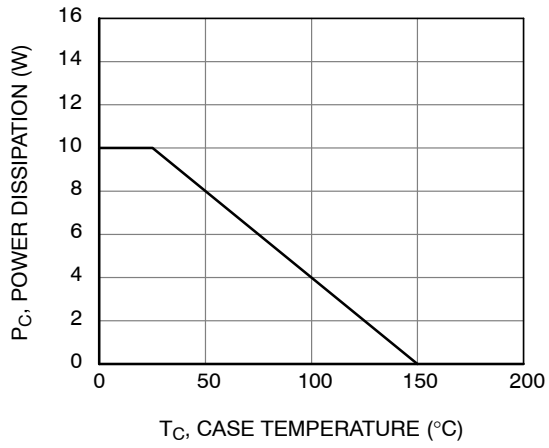

Figure 6. Derating Curve of Safe Operating Areas

# KSA1156

## TYPICAL CHARACTERISTICS (Continued)



**Figure 7. Power Derating**

TO-126-3LD  
CASE 340AS  
ISSUE O

DATE 30 SEP 2016

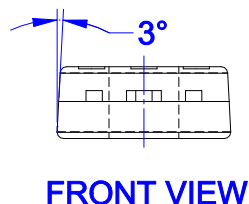
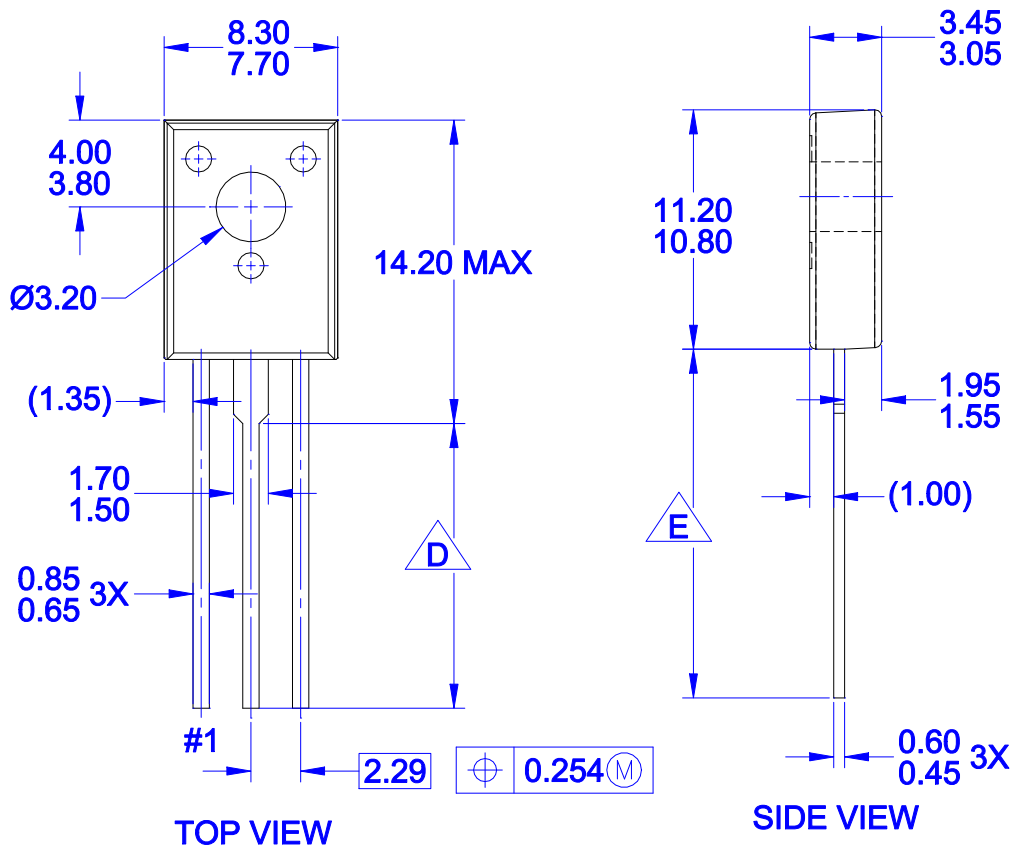

PRODUCTION CODE	TERMINAL LENGTH "D"	TERMINAL LENGTH "E"
TSSTU	3.45 - 4.05	6.45 - 7.45
TSTU	2.36 - 2.96	5.36 - 6.36
NONE (STD LENGTH)	12.76 - 13.36	15.76 - 16.76

NOTES:

- A. NO INDUSTRY STANDARD APPLIES TO THIS PACKAGE
- B. ALL DIMENSIONS ARE IN MILLIMETERS
- C. DIMENSIONS ARE EXCLUSIVE OF BURRS, MOLD FLASH, AND TIE BAR PROTRUSIONS

**D** FOR TERMINAL LENGTH "D", REFER TO TABLE

**E** FOR TERMINAL LENGTH "E", REFER TO TABLE

DOCUMENT NUMBER:	98AON13817G	Electronic versions are uncontrolled except when accessed directly from the Document Repository. Printed versions are uncontrolled except when stamped "CONTROLLED COPY" in red.
DESCRIPTION:	TO-126-3LD	PAGE 1 OF 1

ON Semiconductor and are trademarks of Semiconductor Components Industries, LLC dba ON Semiconductor or its subsidiaries in the United States and/or other countries. ON Semiconductor reserves the right to make changes without further notice to any products herein. ON Semiconductor makes no warranty, representation or guarantee regarding the suitability of its products for any particular purpose, nor does ON Semiconductor assume any liability arising out of the application or use of any product or circuit, and specifically disclaims any and all liability, including without limitation special, consequential or incidental damages. ON Semiconductor does not convey any license under its patent rights nor the rights of others.

**onsemi**, **Onsemi**, and other names, marks, and brands are registered and/or common law trademarks of Semiconductor Components Industries, LLC dba "**onsemi**" or its affiliates and/or subsidiaries in the United States and/or other countries. **onsemi** owns the rights to a number of patents, trademarks, copyrights, trade secrets, and other intellectual property. A listing of **onsemi**'s product/patent coverage may be accessed at [www.onsemi.com/site/pdf/Patent-Marking.pdf](http://www.onsemi.com/site/pdf/Patent-Marking.pdf). **onsemi** reserves the right to make changes at any time to any products or information herein, without notice. The information herein is provided "as-is" and **onsemi** makes no warranty, representation or guarantee regarding the accuracy of the information, product features, availability, functionality, or suitability of its products for any particular purpose, nor does **onsemi** assume any liability arising out of the application or use of any product or circuit, and specifically disclaims any and all liability, including without limitation special, consequential or incidental damages. Buyer is responsible for its products and applications using **onsemi** products, including compliance with all laws, regulations and safety requirements or standards, regardless of any support or applications information provided by **onsemi**. "Typical" parameters which may be provided in **onsemi** data sheets and/or specifications can and do vary in different applications and actual performance may vary over time. All operating parameters, including "Typicals" must be validated for each customer application by customer's technical experts. **onsemi** does not convey any license under any of its intellectual property rights nor the rights of others. **onsemi** products are not designed, intended, or authorized for use as a critical component in life support systems or any FDA Class 3 medical devices or medical devices with a same or similar classification in a foreign jurisdiction or any devices intended for implantation in the human body. Should Buyer purchase or use **onsemi** products for any such unintended or unauthorized application, Buyer shall indemnify and hold **onsemi** and its officers, employees, subsidiaries, affiliates, and distributors harmless against all claims, costs, damages, and expenses, and reasonable attorney fees arising out of, directly or indirectly, any claim of personal injury or death associated with such unintended or unauthorized use, even if such claim alleges that **onsemi** was negligent regarding the design or manufacture of the part. **onsemi** is an Equal Opportunity/Affirmative Action Employer. This literature is subject to all applicable copyright laws and is not for resale in any manner.

## ADDITIONAL INFORMATION

### TECHNICAL PUBLICATIONS:

Technical Library: [www.onsemi.com/design/resources/technical-documentation](http://www.onsemi.com/design/resources/technical-documentation)  
onsemi Website: [www.onsemi.com](http://www.onsemi.com)

### ONLINE SUPPORT: [www.onsemi.com/support](http://www.onsemi.com/support)

For additional information, please contact your local Sales Representative at [www.onsemi.com/support/sales](http://www.onsemi.com/support/sales)