

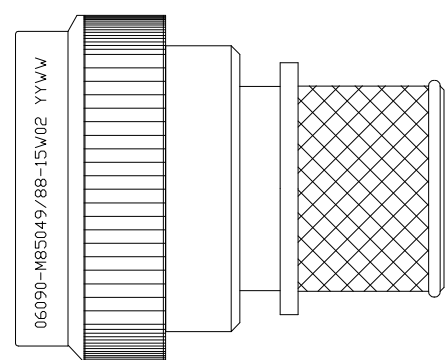

THIS DRAWING IS UNPUBLISHED. RELEASED FOR PUBLICATION
 © COPYRIGHT - - ALL RIGHTS RESERVED.

| REVISIONS | | | | | |
|-----------|-----|-----------------------|--------|-----|------|
| P | LTR | DESCRIPTION | DATE | DWN | APVD |
| | E | REV PER ECO 17-004704 | 6-5-17 | CT | EH |



SELF-LOCKING
 SHIELD BAND TERMINATION
 SHRINK BOOT ACCOMMODATION ADAPTER

1. THIS PRODUCT IS DESIGNED TO TERMINATE A BRAIDED CABLE SHIELD AND A HEAT SHRINKABLE LIPPED BOOT TO A CONNECTOR, AND DESIGNED TO MEET PERFORMANCE REQUIREMENT OF AS85049/88.
2. ALL COMPONENTS SHALL BE PACKAGED AND SUPPLIED IN A PLASTIC BAG AND LABELED WITH M85049/88 DESIGNATION e.g. M85049/88-15W02.
3. PART SUPPLIED WITH STANDARD DETENTED SELF-LOCKING WHICH PROVIDES A POSITIVE AUDIBLE DETENTED COUPLING.
4. THIS ADAPTER MATES TO MIL-DTL-38999 SERIES III AND MIL-DTL-38999 SERIES IV CONNECTORS.
5. FOR MATERIAL AND FINISH INFORMATION REFER TO R85049.
 FOR ALTERNATIVE MATERIALS AND PLATING FINISHES CONTACT TE CONNECTIVITY.

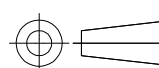
| | | | | | |
|---|--|--------------------------------|---|--------------------|---------------------------|
| THIS DRAWING IS A CONTROLLED DOCUMENT. | | DWN C.C.THOMAS 05JUN2017 |  TE Connectivity | | |
| DIMENSIONS: INCHES | | CHK E.HALEY 6-5-17 | | | |
|  | | APVD E.HALEY 6-5-17 | NAME BACKSHELL, STRAIGHT, SELF-LOCKING, SHIELD BAND TERMINATION, SHRINK BOOT ADAPTER | | |
| TOLERANCES UNLESS OTHERWISE SPECIFIED: | | PRODUCT SPEC | APPLICATION SPEC | | |
| 0 PLC ± - 1 PLC ± - 2 PLC ± - 3 PLC ± - 4 PLC ± - ANGLES ± - | | WEIGHT 0 | SIZE A3 | CAGE CODE 06090 | DRAWING NO C-R85049/88 |
| MATERIAL - | | FINISH - | | RESTRICTED TO - | CUSTOMER DRAWING |
| | | | SCALE NTS | SHEET 1 OF 3 | REV E |

THIS DRAWING IS UNPUBLISHED.

RELEASED FOR PUBLICATION

REVISIONS

© COPYRIGHT - TE Connectivity

ALL RIGHTS RESERVED.

| P | LTR | DESCRIPTION | DATE | DWN | APVD |
|---|-----|-------------|------|-----|------|
| - | - | SEE SHEET 1 | - | - | - |

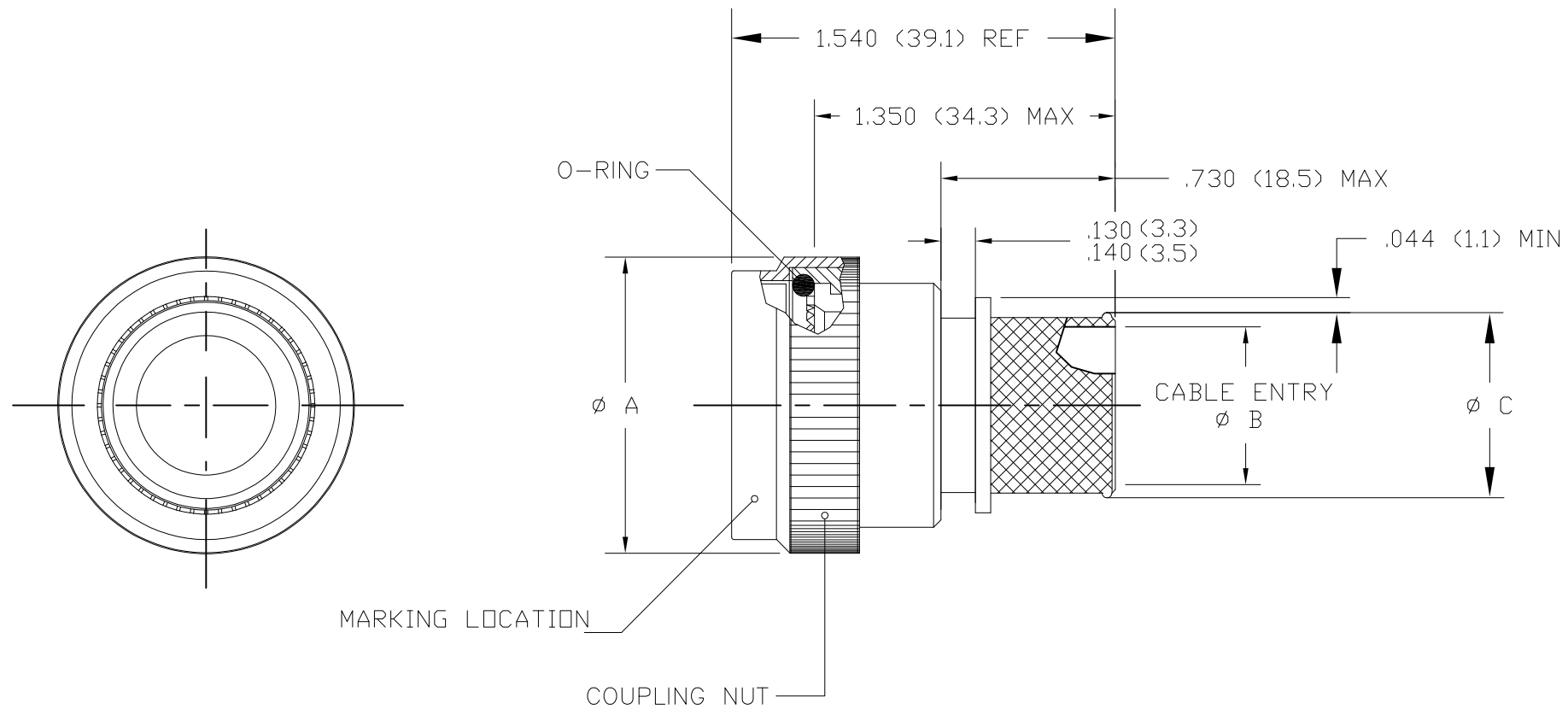

PART NUMBERING

R85049/88 - 15 W 02

- SPECIFICATION SHEET
- CONFIGURATION:
 - (DASH) DETENTED SELF-LOCKING
- ORDER NO.
- FINISH
- ENTRY SIZE

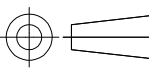
| | | | | | | |
|---|--|--------------------------------|---|-----------|-------------|---------------|
| THIS DRAWING IS A CONTROLLED DOCUMENT. | | DWN C.C.THOMAS 05JUN2017 |  TE Connectivity | | | |
| DIMENSIONS: INCHES | | CHK E.HALEY 6-5-17 | | | | |
|  | | APVD E.HALEY 6-5-17 | NAME BACKSHELL, STRAIGHT, SELF-LOCKING, SHIELD BAND TERMINATION SHRINK BOOT ADAPTER | | | |
| TOLERANCES UNLESS OTHERWISE SPECIFIED: | | PRODUCT SPEC | - | | | |
| 0 PLC ± - 1 PLC ± - 2 PLC ± - 3 PLC ± - 4 PLC ± - ANGLES ± - | | APPLICATION SPEC | - | | | |
| MATERIAL | | WEIGHT | SIZE | CAGE CODE | DRAWING NO | RESTRICTED TO |
| - | | - | A3 | 00779 | C-R85049/88 | - |
| FINISH | | CUSTOMER DRAWING | | SCALE | SHEET | REV |
| - | | - | | NTS | 2 OF 3 | E |

THIS DRAWING IS UNPUBLISHED. RELEASED FOR PUBLICATION
 © COPYRIGHT - TE Connectivity ALL RIGHTS RESERVED.

| REVISIONS | | | | | |
|-----------|-----|-------------|------|-----|------|
| P | LTR | DESCRIPTION | DATE | DWN | APVD |
| - | - | SEE SHEET 1 | - | - | - |

| TABLE I - SHELL SIZE AND DIMENSIONS | | | | | | |
|-------------------------------------|------------|--------------|------------------------|--------------|-------------|--------------|
| ORDER NUMBER | SHELL SIZE | A MAX DIA | B DIA ±.010 ENTRY SIZE | | C DIA REF | |
| | | | Ø2 | Ø3 | Ø2 | Ø3 |
| 9 | A | .858 (21.8) | N/A | .250 (6.4) | N/A | .395 (10.0) |
| 11 | B | .984 (25.0) | N/A | .312 (7.9) | N/A | .457 (11.6) |
| 13 | C | 1.157 (29.4) | .312 (7.9) | .438 (11.1) | .457 (11.6) | .583 (14.8) |
| 15 | D | 1.279 (32.5) | .438 (11.1) | .562 (14.3) | .583 (14.8) | .707 (18.0) |
| 17 | E | 1.406 (35.7) | .500 (12.7) | .625 (15.9) | .645 (16.4) | .770 (19.6) |
| 19 | F | 1.516 (38.5) | .625 (15.9) | .750 (19.1) | .770 (19.6) | .895 (22.7) |
| 21 | G | 1.642 (41.7) | .625 (15.9) | .812 (20.6) | .770 (19.6) | .957 (24.3) |
| 23 | H | 1.768 (44.9) | .688 (17.5) | .938 (23.8) | .829 (21.1) | 1.083 (27.5) |
| 25 | J | 1.889 (48.0) | .750 (19.1) | 1.000 (25.4) | .895 (22.7) | 1.145 (29.1) |

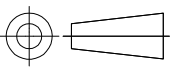
| | | | | | | |
|---|-------------|--------------------------------|---|--------------------|---------------------------|--------------------|
| THIS DRAWING IS A CONTROLLED DOCUMENT. | | DWN C.C.THOMAS 05JUN2017 |  TE Connectivity | | | |
| DIMENSIONS: INCHES | | CHK E.HALEY 6-5-17 | | | | |
|  | | APVD E.HALEY 6-5-17 | NAME BACKSHELL, STRAIGHT, SELF-LOCKING, SHIELD BAND TERMINATION SHRINK BOOT ADAPTER | | | |
| | | PRODUCT SPEC - | APPLICATION SPEC - | | | |
| MATERIAL - | FINISH - | WEIGHT - | SIZE A3 | CAGE CODE 00779 | DRAWING NO C-R85049/88 | RESTRICTED TO - |
| CUSTOMER DRAWING | | | SCALE NTS | SHEET 3 OF 3 | REV E | |

Mouser Electronics

Authorized Distributor

Click to View Pricing, Inventory, Delivery & Lifecycle Information:

[TE Connectivity:](#)

[R85049/88-21W03](#)