

EAC-03-472 / ESC-03-472

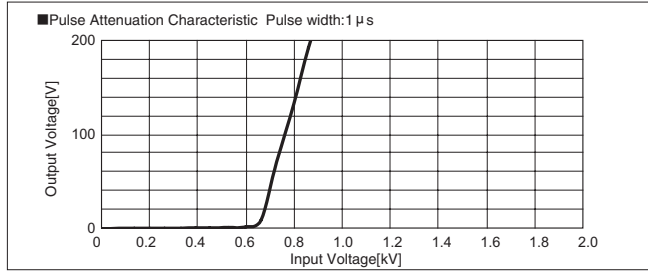

EAC-06-472 / ESC-06-472

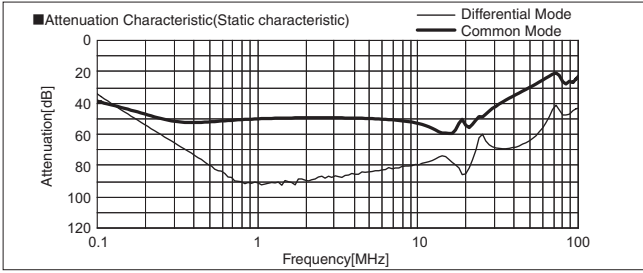
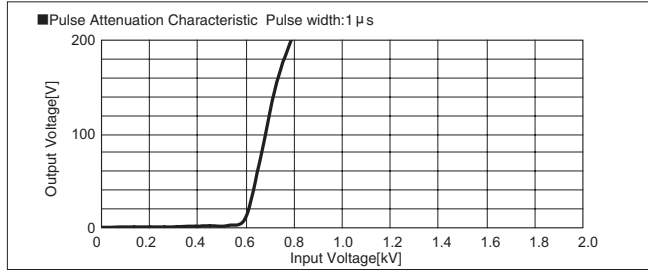
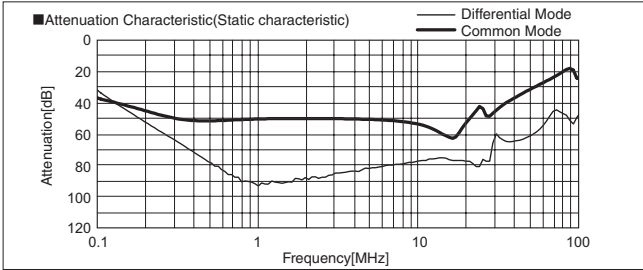

EAC-10-472 / ESC-10-472

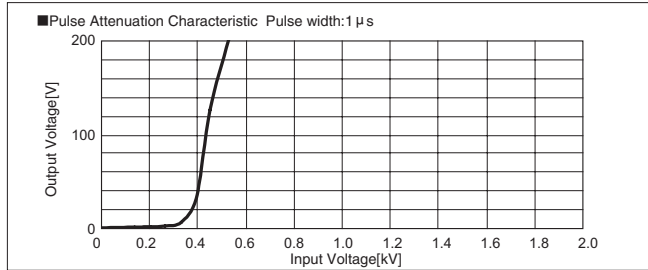
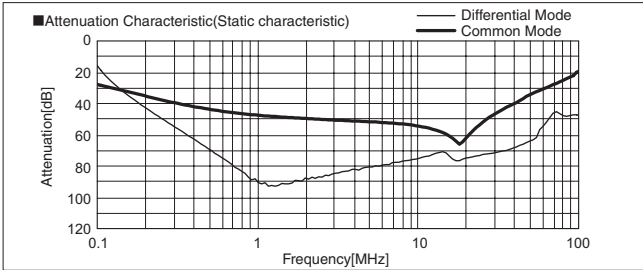

EAC-16-472 / ESC-16-472

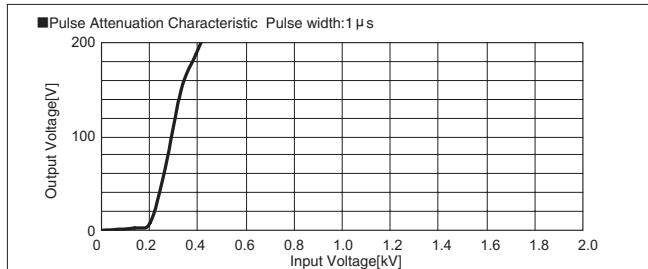
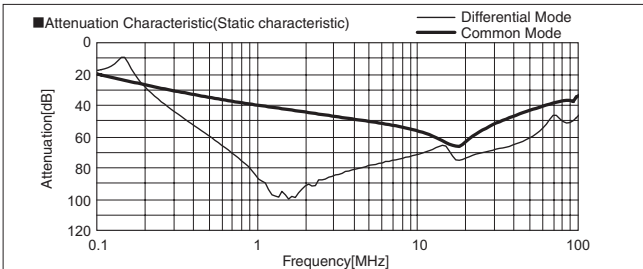

EAC-20-472

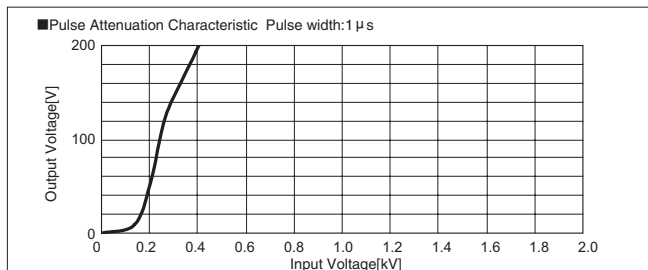
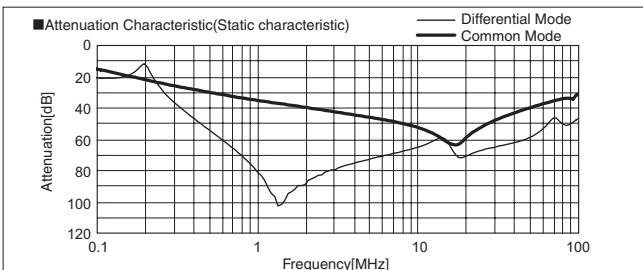

EAC-30-472

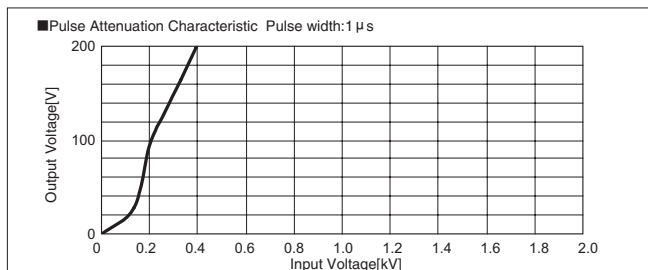
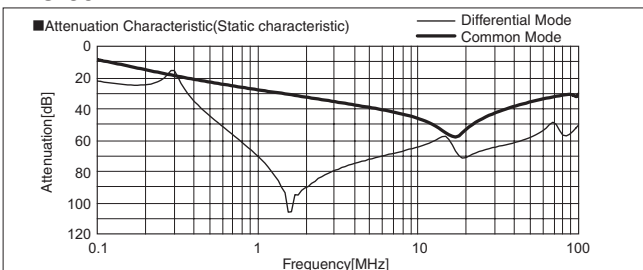

1 Method of connecting EMI/EMC Filter

(1) Single-phase

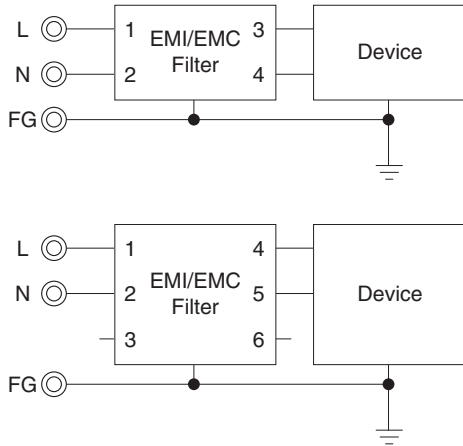

※Three-phase three-wire EMI/EMC filter is also available as a Single-phase input type.

(2) Three-phase three-wire

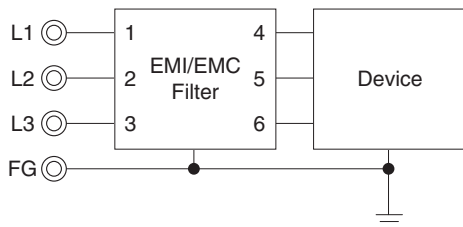

(3) Three-phase four-wire

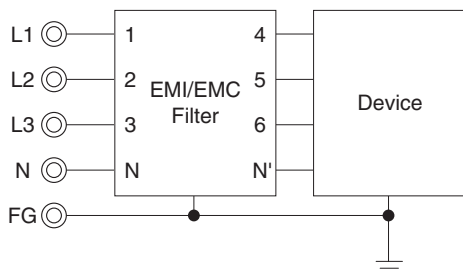

[Reference] Example of calculating input current calculation

Input voltage 400 [V]
Input capacity of the equipment 4000 [VA]

$$\text{Input current} = \frac{4000 \text{ [VA]}}{400 \text{ [V]} \times \sqrt{3}} = 5.8 \text{ [A]}$$

2 Caution when connecting EMI/EMC Filter

Please note the excessive temperature increase of EMI/EMC filter. Please contact us if judgement is difficult.

(1) Input voltage and frequency

Please use within the rated voltage (or maximum voltage) of each model.

Input frequency specification for AC input EMI/EMC filter is considered as commercial frequency (50/60Hz).

It should not be used under the following conditions.

- 1) Distorted input voltage waveform.
(Triangle wave, square wave etc.)
- 2) High input frequency (ex: 400Hz)

(2) Input current

Please use within the rated current of each model.

EMI/EMC filters have short term peak current capability. Therefore, it can flow ~40A or ten times of rated current, non-repeated, within a few ms such as inrush current of power supply etc.

However, it should not be used under the following conditions.

- 1) Long duration peak current.
- 2) Peak current or high-frequency current is continuously flowing.

(3) Connection to a general-purpose inverter (servo driver)

Please connect EMI/EMC filter to input side of inverter driver (servo driver).

It should not be used between the inverter (servo driver) and the motor.

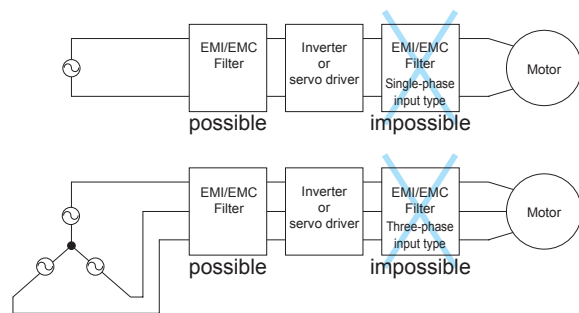

(4) Caution when a Three-phase four-wire system

When using a Three-phase three-wire system input, delta connection cannot be used.

When using the N and N' terminals of the EMI/EMC filter, the neutral line (N phase) must be connected.

If you have a Three-phase four-wire system with a Single-phase load connected between the neutral and each line, the neutral may carry considerably more current than the line current.

Please use this while ensuring that the input current does not exceed the rated current of the EMI/EMC filter.

3 Safety Considerations

- To apply for safety standard approval using this EMI/EMC Filter, the following conditions must be met.
- The unit must be used as a component of an end-use equipment.
- Protection earth terminal (PE) must be connected to safety ground of end-use equipment.

(1) Attenuation Characteristic(Static characteristic)

※ Attenuation= $20\log(U_{b1}/U_{b2})$ (dB)
 U_{b1} : Voltage in state without filters
 U_{b2} : Voltage in state which added filters
 ※ N.A.: Network analyzer

■ Object product : Single-phase input type (Differential mode)

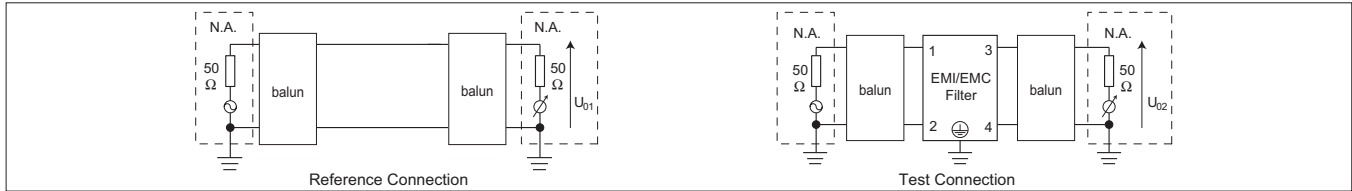

■ Object product : Single-phase input type (Common mode)

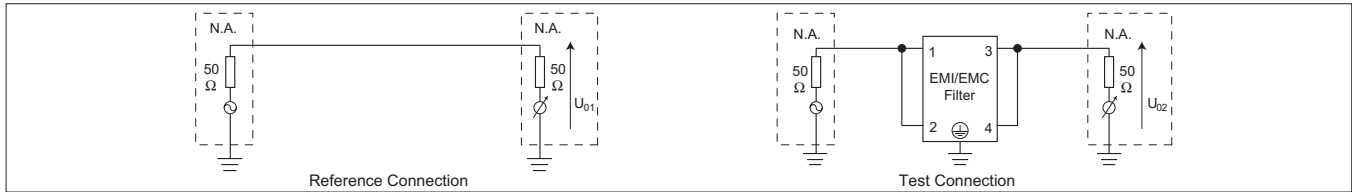

■ Object product : Three-phase three-wire system (Differential mode)

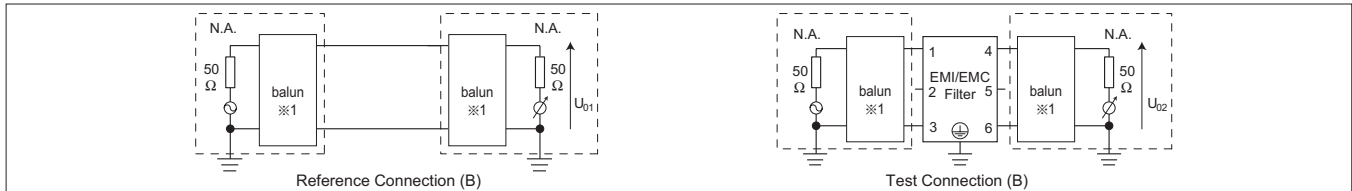
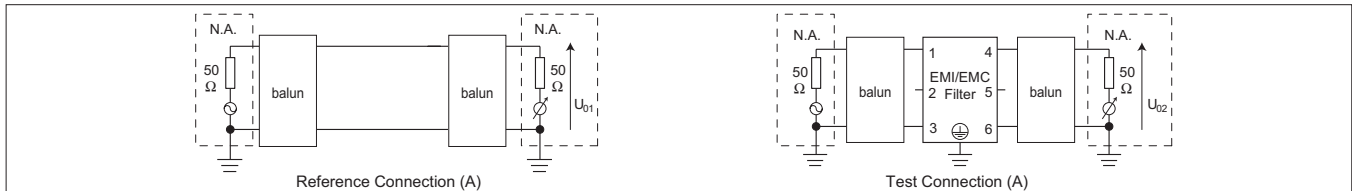

※ Measured with the above test circuit (A) or (B)
 ※1 Equilibrium measurement with mixed-mode S-parameters in the instrument

■ Object product : Three-phase three-wire system (Common mode)



■ Object product : Three-phase four-wire system (Differential mode)

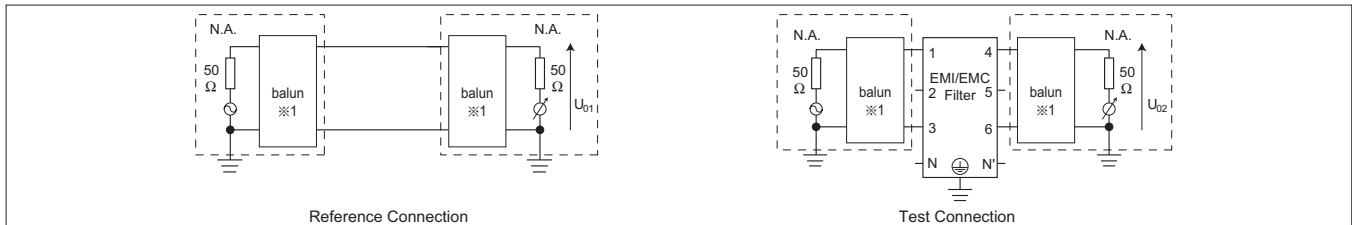

※1 Equilibrium measurement with mixed-mode S-parameters in the instrument

■ Object product : Three-phase four-wire system (Common mode)

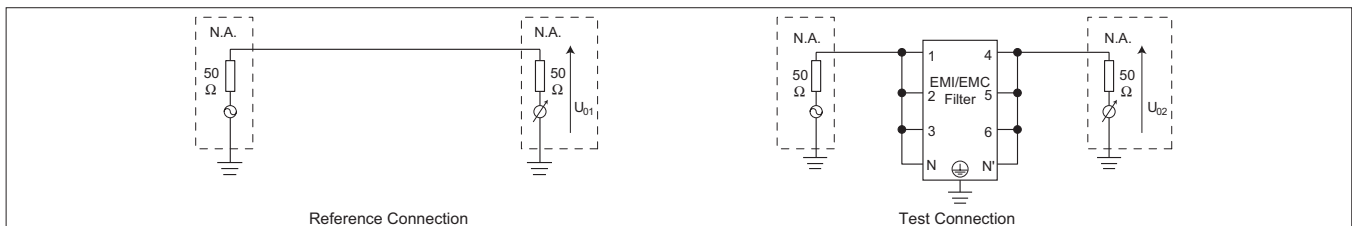

※ Attenuation = $20\log(U_{01}/U_{02})$ [dB]
 U_{01} : Voltage in state without filters
 U_{02} : Voltage in state which added filters
 ※ N.A. : Network analyzer

■ Object product : DC input type (Differential mode)

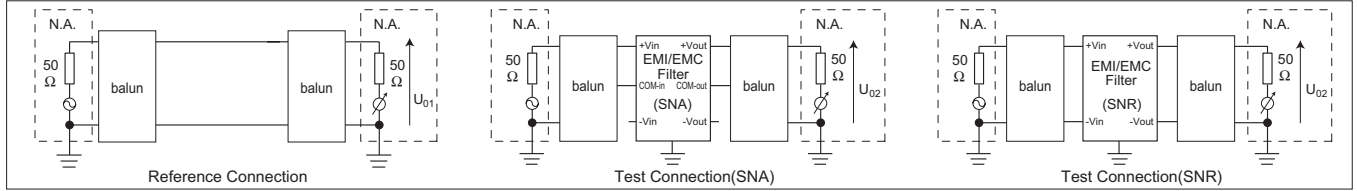

■ Object product : DC input type (Common mode)

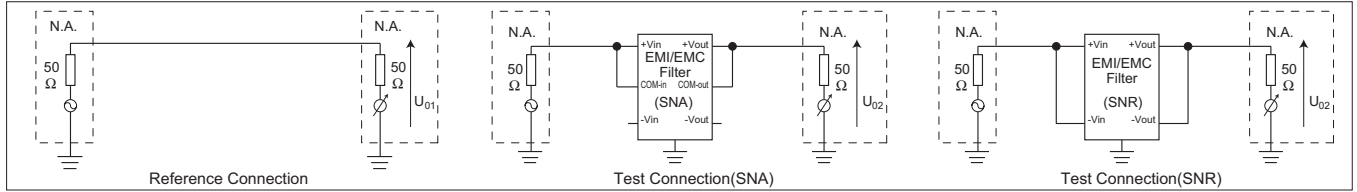

(2) Pulse Attenuation Characteristic

