

Mini-Com® Modular Furniture Faceplates

PANDUIT®

SPECIFICATION SHEET

specifications

Modular furniture faceplates shall be available in multiple port densities, flat or sloped, with or without label pocket. Select furniture faceplates shall mount to standard and/or custom furniture openings depending on the furniture manufacturer it's compatible with. Furniture faceplates will accept any Mini-Com® Module.

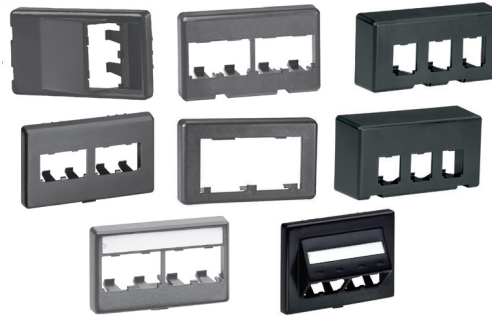

technical information

Mounting options:	Standard sizes have industry standard TIA/EIA opening; custom sizes vary by furniture manufacturer: Standard openings: 1.345"-1.405"(H) x 2.67"-2.75"(W), maximum panel thickness of 0.09"
CFFPHM4**:	1.88"-1.91"(H) x 2.98"-3.03"(W), maximum panel thickness of 0.09"
CFFPEBSL4**:	2.38"(H) x 3.44"(W), maximum panel thickness of 0.05"
CFFPKE3**:	1.60"(H) x 3.36"(W), maximum panel thickness of 0.04"
Packaging:	Versions with label include label and label cover

key features and benefits

Modular	Accepts all Mini-Com® Modules, which snap in and out for easy moves, adds, and changes
Bend radius control	Bend radius can be protected or improved by using a sloped design or the faceplate extender, which will add 0.5" to the in-wall depth
Identification	Select faceplates include label pockets with labels and label covers for easy identification of ports; optional adhesive labels available
Various port densities	Provides design flexibility

applications

The 2 and 4 position furniture faceplates (CFFP4**, CFFPL4**, CFFPLA4**, and CFFPA2**) are used in work areas with modular furniture which have the TIA/EIA standard furniture outlet opening. Modular furniture manufacturers like Herman Miller^ and Knoll^ have custom openings for various models of furniture. The CFFPHM4** can be used with Herman Miller Action Office 2 and 3, and Baseline furniture series. The

CFFPEBSL4** is designed to work with the Ethospace Beltline series, and is a 4-position sloped faceplate. Knoll Equity^ furniture can utilize CFFPKE3**, which is a 3-position furniture faceplate that is extended off the face of the furniture. Also offered is a comparable 3-position faceplate, CFFPE3**, which adapts to Knoll's Morrison^^ Series, in addition to the TIA/EIA standard opening.

Modular Furniture Faceplates (for standard openings)

4 module space:	CFFP4IW*
4 module space (with labels):	CFFPL4IW*
4 module space sloped (with labels):	CFFPLA4IW*
2 module space sloped:	CFFPA2IW*
3 module space Knoll Morrison^^:	CFFPE3BL

Modular Furniture Faceplates (for custom openings)

4 module space Herman Miller^:	CFFPHM4IW*
4 module space sloped Herman Miller^ Ethospace Beltline with label and icon slots:	CFFPEBSL4IW*
3 module space Knoll Equity^^:	CFFPKE3BL

Label Options for Three Module Space Faceplates

Laser/inkjet:	C061X030FJJ
PanTher™ LS8E:	C061X030FJC

Label Options for Two and Four Module Space Faceplates (without labels)

Laser/inkjet:	C125X030FJJ
PanTher™ LS8E:	C125X030FJC

Label Options for Four Module Space Faceplates (with labels)

Laser/inkjet:	C261X035Y1J
PanTher™ LS8E:	C261X035Y1C

Accessories

Modular furniture faceplate extender:	MFFPEIW*
(For use with CFFP4, CFFPL4, and CFFPE3)	

Replacement labels and label covers:	C4PPLK
(For faceplates with labels)	

*For other colors, replace suffix IW (Off White) with EI (Electric Ivory), WH (White), or IG (International Gray).

^Herman Miller is a trademark of Herman Miller, Inc. Zeeland, MI.

^^Knoll and Equity are registered trademarks of Knoll, Inc.

^^Morrison is a trademark of Knoll, Inc.

Mini-Com® Modular Furniture Faceplates

2 Module Space Sloped (CFFPA2)

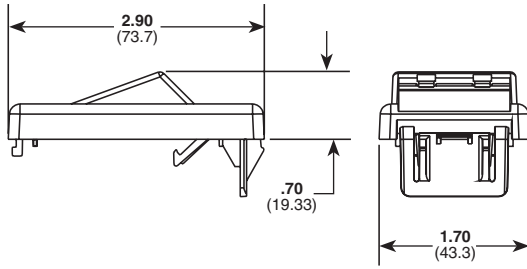

Extender (MFFPE)

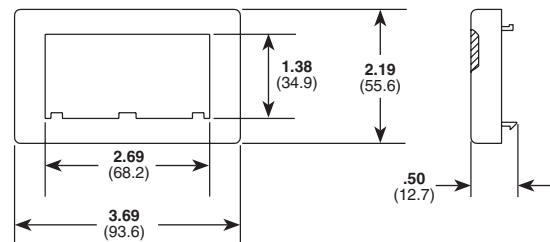

4 Module Space (CFFP4 & CFFPL4)

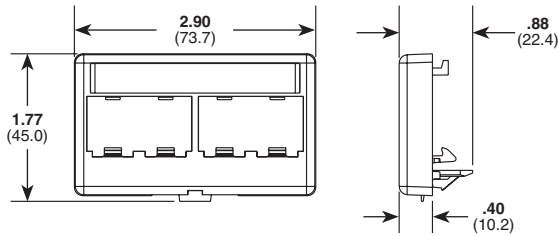

4 Module Space Herman Miller^ (CFFPHM4)

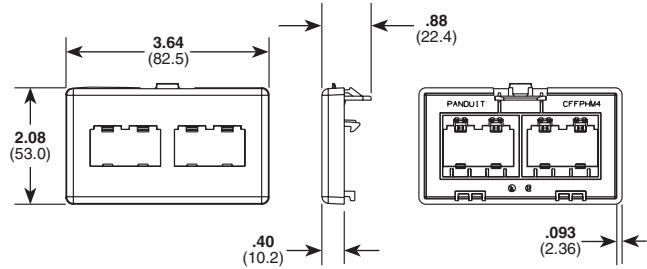

4 Module Space Sloped with labels (CFFPLA4)

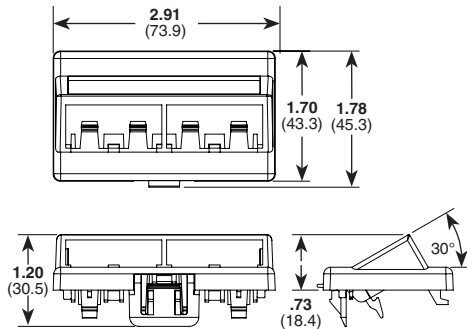

4 Module Space Sloped Herman Miller^ Ethospace Beltline (CFFPEBSL4)

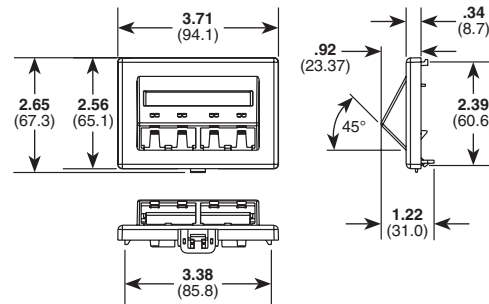

3 Module Space Knoll Equity^^ (CFFPKE3)

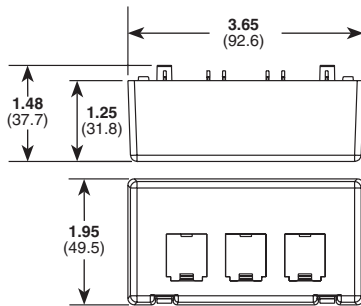

3 Module Space Knoll Morrison^^^ (CFFPE3)

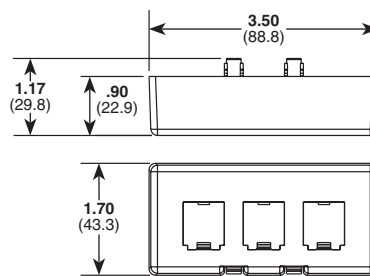

Dimensions are in inches [Dimensions in parenthesis are metric]

WORLDWIDE SUBSIDIARIES AND SALES OFFICES

PANDUIT CANADA
Markham, Ontario
cs-cdn@panduit.com
Phone: 800.777.3300

PANDUIT EUROPE LTD.
London, UK
cs-emea@panduit.com
Phone: 44.20.8601.7200

PANDUIT SINGAPORE PTE. LTD.
Republic of Singapore
cs-ap@panduit.com
Phone: 65.6305.7575

PANDUIT JAPAN
Tokyo, Japan
cs-japan@panduit.com
Phone: 81.3.6863.6000

PANDUIT LATIN AMERICA
Guadalajara, Mexico
cs-la@panduit.com
Phone: 52.33.3777.6000

PANDUIT AUSTRALIA PTY. LTD.
Victoria, Australia
cs-aus@panduit.com
Phone: 61.3.9794.9020

For a copy of Panduit product warranties, log on to www.panduit.com/warranty

For more information

Visit us at www.panduit.com

Contact Customer Service by email: cs@panduit.com
or by phone: 800.777.3300



©2015 Panduit Corp.
ALL RIGHTS RESERVED.
OTSP32--WW-ENG
Replaces WW-OTSP19
1/2015

Mouser Electronics

Authorized Distributor

Click to View Pricing, Inventory, Delivery & Lifecycle Information:

Panduit:

[CFFPL4BL](#) [CFFPHM4BL](#) [CFFPA2IW](#) [CFFPA2BL](#) [CFFPA2IG](#) [CFFPHM4IW](#) [CFFPHM4IG](#) [CFFPHM4EI](#)
[CFFPHM4WH](#) [CFFPE3BL](#) [CFFPL4IG](#) [CFFPEBSL4IW](#) [CFFPEBSL4BL](#) [CFFPEBSL4IG](#) [CFFPL4IW](#) [CFFP4IG](#)
[CPPLF-5](#) [CFFP4IW](#)