

Material Frame: Resin (PPE+PS) UL file no. E82268 94V-0

92 mm sq. type

Model no.	Mass (g)
109-1001G	12

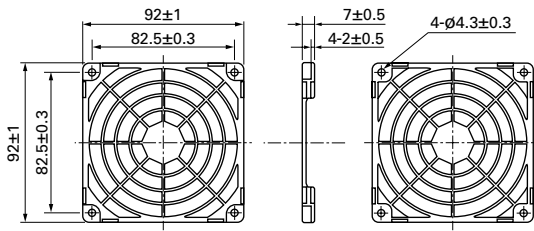

Airflow - Static pressure characteristics

Measured with our double chamber measuring device (120 mm sq. type)

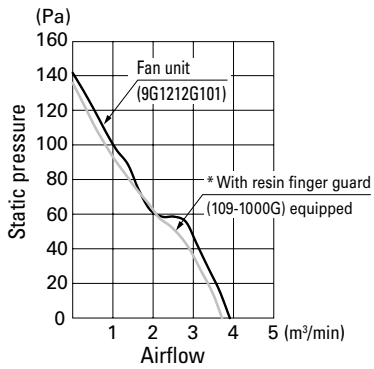

Applied voltage: 12 VDC

* Finger guard is attached on air inlet side of fan.

Mounting example

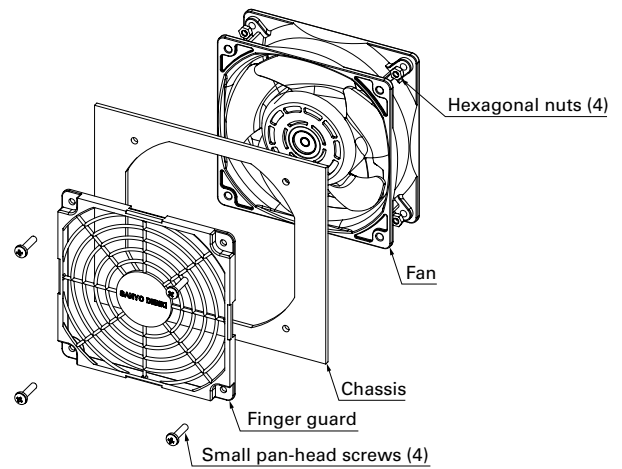

- Operating temperature limit is between -20 to +70°C. (non condensing)
- Plastic finger guards are placed on both the intake and exhaust sides of the fan.
- No nuts or screws for use in attachment included.

Mouser Electronics

Authorized Distributor

Click to View Pricing, Inventory, Delivery & Lifecycle Information:

[Sanyo Denki:](#)

[109-1001G](#)