



THIS DRAWING IS UNPUBLISHED. RELEASED FOR PUBLICATION
 © COPYRIGHT - By - ALL RIGHTS RESERVED.

LOC	DIST	REVISIONS					
		P	LTR	DESCRIPTION	DATE	DWN	APVD
			D2	REVISED PER ECO-12-022400	28DEC12	HMR	MB









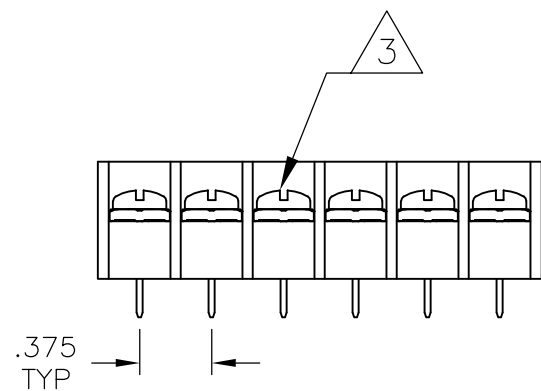
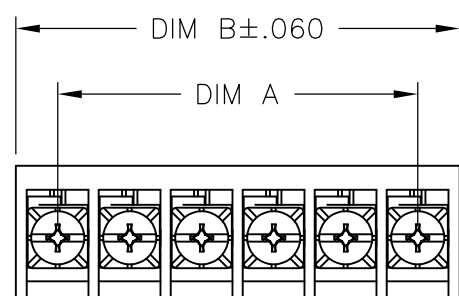

MATERIAL:
 HOUSING: THERMOPLASTIC, UL94V-2.
 TERMINALS: BRASS, BRIGHT TIN PLATE.
 SCREWS: 6-32, STEEL, PLATED ZINC W/ CLEAR CHROMATE COATING. UNLESS OTHERWISE SPECIFIED.
 RECOMMENDED TIGHTENING TORQUE: 12 IN-LBS

ELECTRICAL:
 MAXIMUM CURRENT: 20A.
 OPERATING VOLTAGE: 300V.
 WIRE RANGE: 12-22 AWG.

ENVIRONMENTAL:
 OPERATING TEMP.: -60°C TO 105°C

-  WHITE MARKING AS SHOWN.
-  SCREWS BOTTOMED TO 3-5 IN-LBS
-  ALL SCREWS BOTTOMED, TORQUE 2 TO 4 IN-LBS



OBSOLETE	Notes	DIM B	DIM A	NO. OF POS.	CATALOG NUMBER	PART NUMBER
		7.561	7.125	20	RSB6VP201202	2-1437408-6
		7.186	6.750	19	RSB6VP191202	2-1437408-4
		6.811	6.375	18	RSB6VP181202	2-1437408-1
		6.061	5.625	16	RSB6VP16120222N1760	2-1437417-5
		6.061	5.625	16	RSB6VP16120222N60	1-1437408-9
		6.061	5.625	16	RSB6VP16120221N2060	1-796609-6
		6.061	5.625	16	RSB6VP1620221N60	1-1437408-7
		6.061	5.625	16	RSB6VP161202	1-1437408-6
OBSOLETE		5.311	4.875	14	RSB6VP141202	1-1437408-2
OBSOLETE		4.936	4.500	13	RSB6VP131202	1-1437408-0
OBSOLETE		4.561	4.125	12	RSB6VP121202	1-1437408-8
OBSOLETE		4.186	3.750	11	RSB6VP111202	1-1437408-7
		3.811	3.375	10	RSB6VP101202	1-1437408-1
		3.436	3.000	9	RSB6VP09120222N60	9-1437407-6
		3.436	3.000	9	RSB6VP09120221N60	9-1437407-5
OBSOLETE		3.436	3.000	9	RSB6VP091202	9-1437407-4
OBSOLETE		3.061	2.625	8	RSB6VP081202	8-1437407-8
		2.686	2.250	7	RSB6VP071902	8-1437407-7
OBSOLETE		2.686	2.250	7	RSB6VP071202	8-1437407-6
OBSOLETE		2.311	1.875	6	RSB6VP061202	7-1437407-9
OBSOLETE		1.936	1.500	5	RSB6VP05120221AA	7-796933-1
OBSOLETE		1.936	1.500	5	RSB6VP051202	7-1437407-4
		1.561	1.125	4	RSB6VP041202	7-1437407-0
		1.186	.750	3	RSB6VP03120211	1-1986391-3
OBSOLETE		1.186	.750	3	RSB6VP031202	6-1437407-3
		.811	.375	2	RSB6VP08120222N1960	5-1437407-9
		.811	.375	2	RSB6VP021202N60	6-1437407-0
		.811	.375	2	RSB6VP021202	5-1437407-8

THIS DRAWING IS A CONTROLLED DOCUMENT.		DWN S SCHLEGEL 02OCT2008	 TE Connectivity													
DIMENSIONS: INCHES		CHK S MACE 10/2/08														
TOLERANCES UNLESS OTHERWISE SPECIFIED:		APVD S MACE 10/2/08	NAME													
<table border="0"> <tr><td>0 PLC</td><td>± -</td></tr> <tr><td>1 PLC</td><td>± -</td></tr> <tr><td>2 PLC</td><td>± .02</td></tr> <tr><td>3 PLC</td><td>± .010</td></tr> <tr><td>4 PLC</td><td>± -</td></tr> <tr><td>ANGLES</td><td>± 2'</td></tr> </table>		0 PLC	± -	1 PLC	± -	2 PLC	± .02	3 PLC	± .010	4 PLC	± -	ANGLES	± 2'	PRODUCT SPEC	RSB6 ASSEMBLY	
0 PLC	± -															
1 PLC	± -															
2 PLC	± .02															
3 PLC	± .010															
4 PLC	± -															
ANGLES	± 2'															
MATERIAL		APPLICATION SPEC	SIZE	CAGE CODE	DRAWING NO	RESTRICTED TO										
FINISH		WEIGHT	A3	00779	C-5-1437407-8	-										
CUSTOMER DRAWING			SCALE	SHEET	REV											
			1:1	1 OF 2	D2											

THIS DRAWING IS UNPUBLISHED. RELEASED FOR PUBLICATION
 © COPYRIGHT - By - ALL RIGHTS RESERVED.

LOC	DIST	REVISIONS			
P	LTR	DESCRIPTION	DATE	DWN	APVD
-	-	SEE SHEET 1	-	-	-

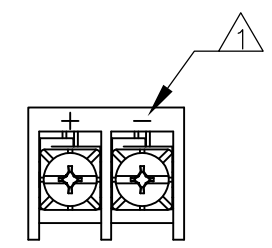

5-1437407-9

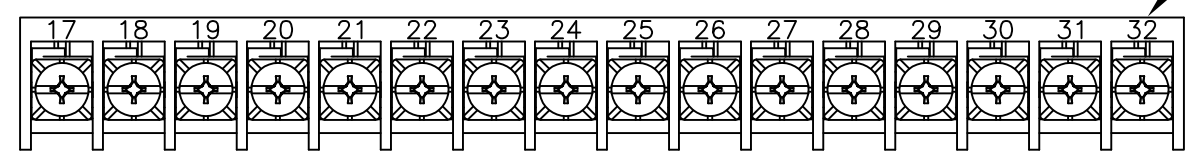

1-796609-6

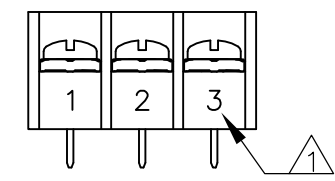

1986391-3

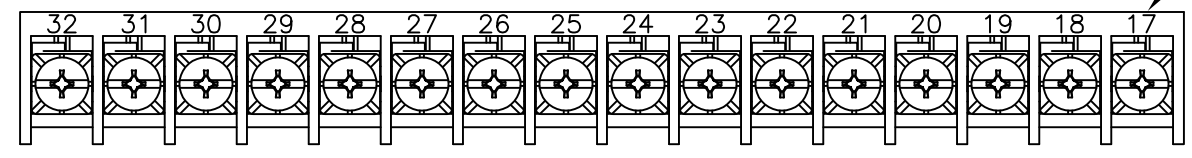

2-1437417-5

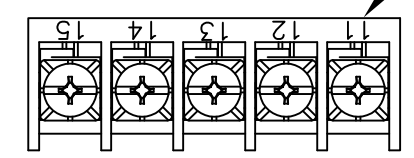

796933-1

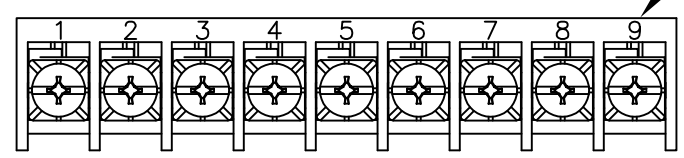

9-1437407-5

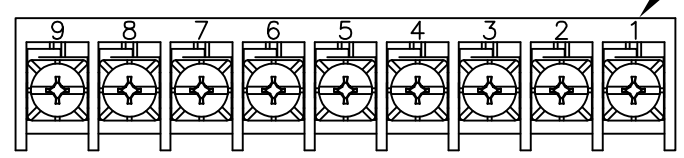

9-1437407-6

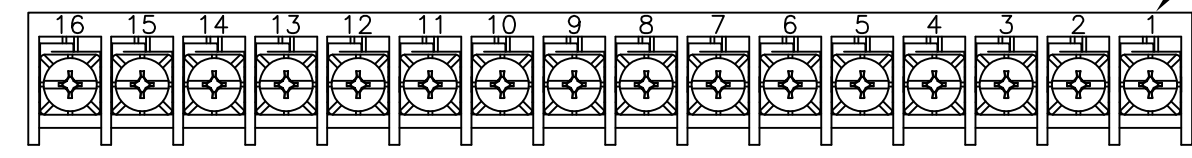

1-1437408-9

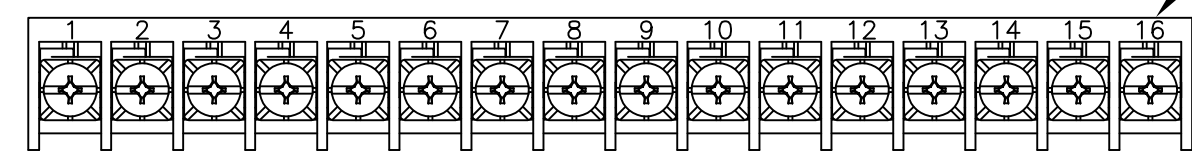

1-1437408-7

OBSOLETE	9.061	8.625	24	RSB6VP241202	3-1437408-2
	8.686	8.250	23	RSB6VP231202	3-1437408-1
	8.311	7.875	22	RSB6VP221202	2-1437408-8
	7.936	7.500	21	RSB6VP211202	2-1437408-7
DIM B	DIM A	NO. OF POS.	CATALOG NUMBER	PART NUMBER	

THIS DRAWING IS A CONTROLLED DOCUMENT.

DIMENSIONS: INCHES	TOLERANCES UNLESS OTHERWISE SPECIFIED:	DWN S SCHLEGEL 02OCT2008	STE TE Connectivity			
	0 PLC ± - 1 PLC ± - 2 PLC ± .02 3 PLC ± .010 4 PLC ± - ANGLES ± 2'	CHK S MACE 10/2/08 APVD S MACE 10/2/08				
MATERIAL -	FINISH -	PRODUCT SPEC -	NAME RSB6 ASSEMBLY			
		APPLICATION SPEC -	SIZE A3	CAGE CODE 00779	DRAWING NO C-5-1437407-8	RESTRICTED TO -
		WEIGHT -	CUSTOMER DRAWING		SCALE 1:1	SHEET 2 OF 2
					REV D2	

Mouser Electronics

Authorized Distributor

Click to View Pricing, Inventory, Delivery & Lifecycle Information:

[TE Connectivity:](#)

[RSB6VP09120222N60](#) [RSB3VP021201](#) [RSB6VP241202](#)