

High Performance Dual Output Synchronous Buck EVM

Contents

1	Introduction	3
2	Description	3
	2.1 Typical Applications	3
	2.2 Features	3
3	Electrical Performance Specifications	4
4	Schematic	5
5	Test Setup	6
	5.1 Test Equipment	6
	5.2 Recommended Test Setup	6
	5.3 List of Test Points	7
6	Test Procedure	8
	6.1 Line/Load Regulation and Efficiency Measurement Procedure	8
	6.2 Output Ripple Test	9
	6.3 Measuring Improved Light Load Efficiency	9
	6.4 Control Architecture and OVP Select	10
	6.5 Over Current Trip Level and Output Discharge Select	10
7	Performance Data and Typical Characteristic Curves	11
	7.1 Efficiency	11
	7.2 Load Regulation	11
	7.3 Bode Plot	12
	7.4 Transient Response	12
	7.5 Output Ripple and Switch Node	13
	7.6 Turn-On Waveform	13
	7.7 Turn-Off Waveform	14
8	EVM Assembly Drawing and PCB Layout	15
9	List of Materials	21

List of Figures

1	TPS51220A EVM-476 Schematic	5
2	TPS51220A EVM-476 Recommended Test Set Up.....	6
3	Recommended “Tip and Barrel” Technique to Measure Output Ripple Voltage	6
4	Efficiency, 12 V _{IN} , 5.0-V Output.....	11
5	Efficiency, 12 V _{IN} , 3.3-V Output.....	11
6	12 V _{IN} , 5.0-V Load Regulation	11
7	12 V _{IN} , 3.3-V Load Regulation	11
8	CCM mode 5-V Loop Response Gain and Phase, f _{CO} = 95 kHz, PM = 48°	12
9	CCM mode 3.3-V Loop Response Gain and Phase, f _{CO} = 90 kHz, PM = 63°	12
10	5-V CCM Mode Load Transient	12
11	5-V D-CAP Mode Load Transient	12
12	5-V CCM Mode Output Ripple and Switch Node.....	13
13	3.3-V CCM Mode Output Ripple.....	13
14	Enable Turn-On Waveform.....	13

15	Enable Turn-Off With Discharge Waveform	14
16	Enable Turn-Off Without Discharge Waveform.....	14
17	Top Layer Assembly Drawing (Top view)	15
18	Bottom Assembly Drawing (Top view)	16
19	Top Copper (Top View).....	17
20	Internal Layer 1 (Top View)	18
21	Internal Layer 2 (Top View)	19
22	Bottom Copper (Top View).....	20

List of Tables

1	TPS51220A EVM-476 Electrical Performance Specifications	4
2	Test Point Functions Found on the TPS51220A EVM-476.....	7
3	SKIPSEL1 or SKIPSEL2 (jumpers JP1 and JP4) Selections	9
4	FUNC (jumper JP2) Selections	10
5	TRIP (JP3) Selections	10
6	EVM Components List According to Schematic Shown in	21

1 Introduction

This EVM utilizes TI's TPS51220A in a dual output design. It includes many test points to help the engineer monitor and evaluate the control characteristics of the TPS51220A. The TPS51220A is a dual peak current mode synchronous buck controller with three linear regulators. The EVM also allows the engineer to configure several of the features of the TPS51220A controller.

2 Description

The TPS51220A EVM-476 provides two 8-A outputs, 3.3 V and 5 V. It accepts an input voltage from 8 V to 20 V. Several jumpers and switches allow the user to evaluate various control functions of the TPS51220A. Switches provide an easy method to enable and disable the EVM or each of the two outputs independently. Two jumper blocks allow the user to select the mode of operation of each output. One jumper block allows the engineer to select the control architecture and OVP function. And one block allows for selection of over current trip level and if the output is discharged by the converter. See sections below for more details.

2.1 Typical Applications

- Notebook Computers and I/O Bus
- Point-of-load in such Applications as Digital TV and Multi-Function Printers

2.2 Features

- Input Range from 8 V to 20 V
- Dual 8-A Outputs, 3.3 V and 5 V
- Individual Enable Function for 3.3-V and 5-V Output
- Selectable Light Load Operation
- Selectable Control Architecture
- Inductor Current Sensing
- OVP Disable Function
- Output Discharge Disable Function
- Test Points for Easy Access to Measure Key Parameters

3 Electrical Performance Specifications

Table 1. TPS51220A EVM-476 Electrical Performance Specifications

PARAMETER	TEST CONDITIONS	MIN	TYP	MAX	UNITS
Input Characteristics					
Voltage range		8	12	20	V
Maximum input current	12 V _{IN} , both outputs at 8 A.		5.8		A
Output Characteristics					
Output voltage, V _{OUT 1}			5		V
Output load current, I _{OUT1}		0		8	A
Output voltage regulation	Line regulation: input voltage = 8 V to 20 V		±0.5		%
	Load regulation: output current = 0 A to 8 A		±1		%
Output voltage ripple	At I _{OUT1} = 8 A			50	mVpp
Output over current			12		A
Switching frequency			330		kHz
Peak efficiency			97.8		%
Full load efficiency			96.9		%
Output voltage, V _{OUT 2}			3.3		V
Output load current, I _{OUT2}		0		8	A
Output voltage regulation	Line Regulation: Input voltage = 8V to 20V		±0.5		%
	Load Regulation: Output current = 0A to 8A		±1		%
Output voltage ripple	At I _{OUT} = 8 A			50	mVpp
Output over current			12		A
Switching frequency			330		kHz
Peak efficiency			96		%
Full load efficiency			95		%

4 Schematic

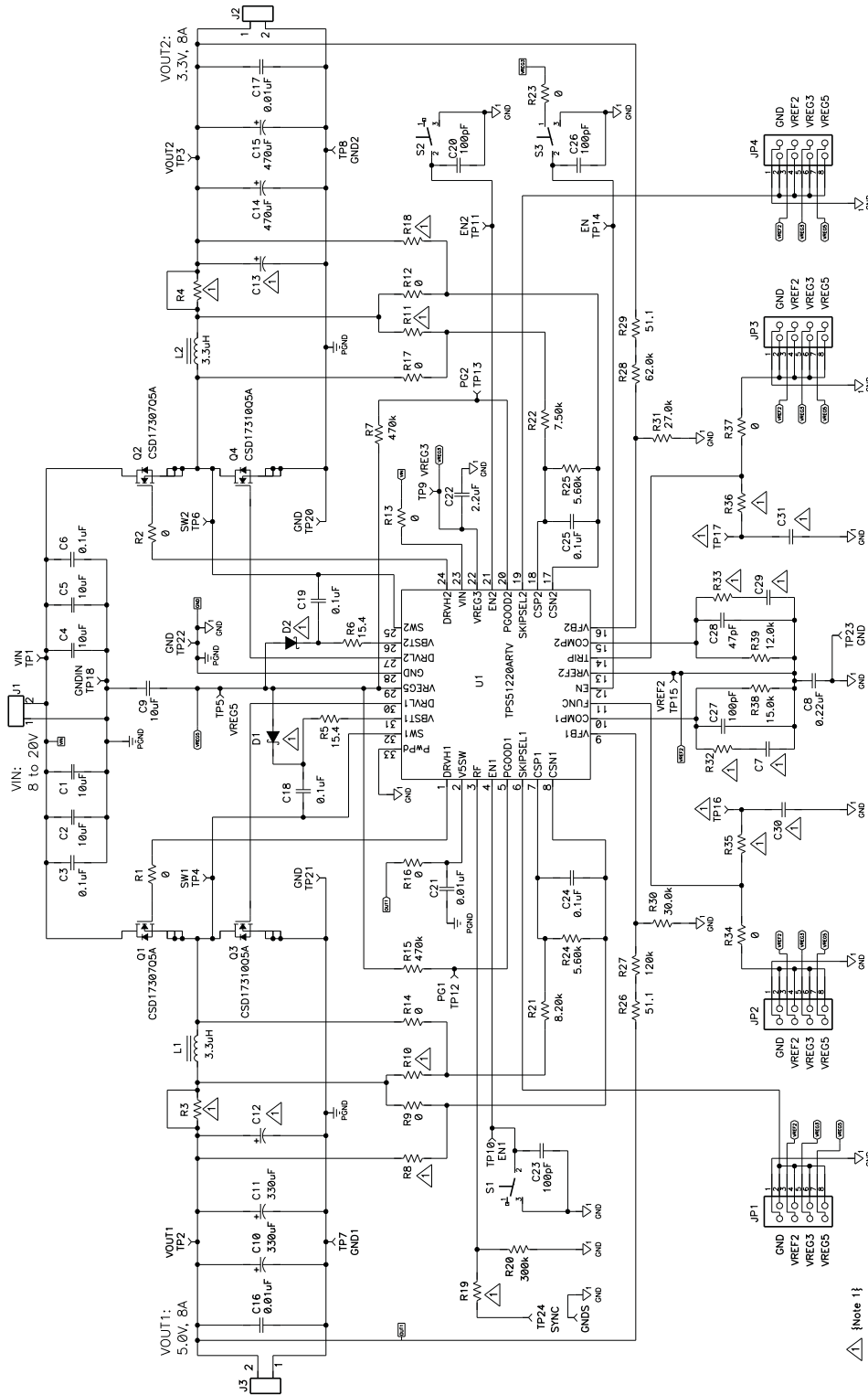

Figure 1. TPS51220A EVM-476 Schematic

5 Test Setup

5.1 Test Equipment

Voltage Source: The power source must be capable of supplying 8 VDC to 20 VDC at up to 10 A.

Multimeters: A minimum of three voltage meters are required. Other voltage meters can be used to monitor some of the test points.

Output Load: Two constant current electronic loads are recommended. They must be able to sink up to 10 A when the output is 3.3 V or 5V.

Oscilloscope: A minimum 50-MHz digital oscilloscope and a voltage probe is required. The scope can be used to measure output ripple and monitor some of the test points

Fan: A fan is not required when testing the EVM

Recommended Wire Gauge: Both loads and input should be connected using a minimum gauge wire of AWG#16. Also these connections should be kept as short as possible.

5.2 Recommended Test Setup

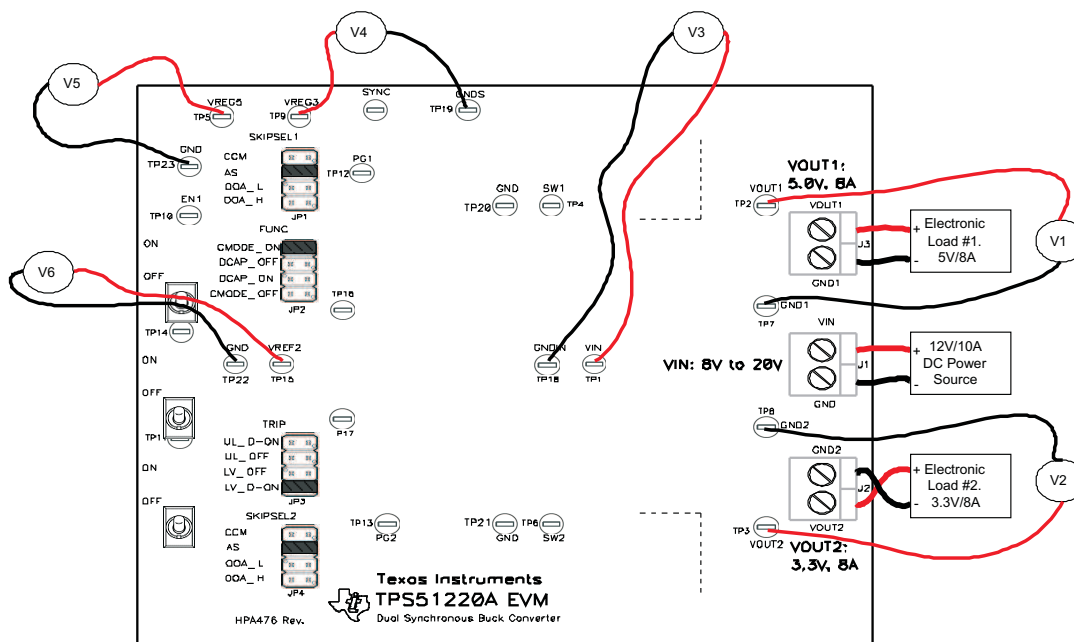

Figure 2. TPS51220A EVM-476 Recommended Test Set Up

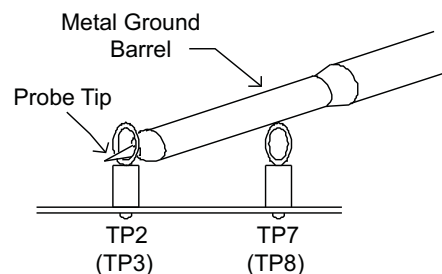

Figure 3. Recommended "Tip and Barrel" Technique to Measure Output Ripple Voltage

5.3 List of Test Points

Table 2. Test Point Functions Found on the TPS51220A EVM-476

TEST POINT	NAME	DESCRIPTION
TP1	VIN	Measurement point for input voltage with respect to TP18
TP2	VOUT1	Measurement point for output 1 voltage with respect to TP7
TP3	VOUT2	Measurement point for output 2 voltage with respect to TP8
TP4	SW1	Output 1 switch node with respect to TP20
TP5	VREG5	5-V/100-mA output, enabled EN is high, use switch S3
TP6	SW2	Output 2 switch node with respect to TP21
TP7	GND1	Ground reference for VOUT1
TP8	GND2	Ground reference for VOUT2
TP9	VREG3	3.3-V/10-mA output should be present when input voltage is applied to EVM.
TP10	EN1	Output 1 enable signal, will be high when output is enabled via switch S1
TP11	EN2	Output 2 enable signal, will be high when output is enabled via switch S2
TP12	PG1	Output 1 power good signal, will be high when output is in regulation
TP13	PG2	Output 2 power good signal, will be high when output is in regulation
TP14	EN	5-V and 2-V reference enable signal, high when EVM is enabled via switch S3
TP15	VREF2	2-V internal reference, enabled when EN is high, use switch S3
TP16	–	Not used
TP17	–	Not used
TP18	GNDIN	Ground reference for VIN
TP19	GNDS	General ground
TP20	GND	Ground reference for SW1
TP21	GND	Ground reference for SW2
TP22	GND	General ground
TP23	GND	General ground
TP24	SYNC	Not used

6 Test Procedure

6.1 Line/Load Regulation and Efficiency Measurement Procedure

1. Ensure the switches S1 (EN1), S2 (EN2) and S3 (EN) are in the “OFF” position.
2. Ensure the shunt jumper are set as follows, see sections [Section 6.3](#), [Section 6.4](#) and [Section 6.5](#) for details on how to change these settings:
 - (a) JP1 (SKIPSEL1): jumper 3 pin to 4 pin (AS),
 - (b) JP2 (FUNC): jumper 1 pin to 2 pin (CMODE_ON),
 - (c) JP3 (TRIP): jumper 7 pin to 8 pin (LV_D-ON),
 - (d) JP4 (SKIPSEL2): jumper 3 pin to 4 pin (AS).
3. Set the DC power source current limit to 10 A. Increase VIN voltage from 0 V to 8 VDC. V3 should be used to verify VIN.
4. Measure VREG3 (TP9) voltage using V4. It should be between 3.2 V and 3.4 V.
5. Set S3 (EN) to “ON” position. Measure VREG5 (TP5) voltage using V5, it should read between 4.9 V and 5.1 V. Measure VREF2 (TP15) voltage using V6, it should read 1.98 V to 2.02 V.
6. Make sure electronic load #1 is set to sink 0 A. Set S1 (EN1) to “ON” position, S3 remains in “ON” position.
7. Record VOUT1 voltage using V1, IOUT1 current, VIN using V3 and input current from source.
8. Increase electronic load #1’s current in 0.5-A steps from 0 A to 8 A, Record VOUT1 voltage using V1, IOUT1 current, VIN using V3 and input current from source for each step.
9. Set input voltage to 20 V.
10. Reduce electronic load #1’s current from 8 A to 0 A, electronic load #1’s current in 0.5-A steps from 0 A to 8 A, Record VOUT1 voltage using V1, IOUT1 current, VIN using V3 and input current from source for each step.
11. Similar technique can be used for VOUT2. Use S2 to enable VOUT2.

6.2 Output Ripple Test

1. Use steps 1 to 6 of section [Section 6.1](#) to start output.
2. Set up the scope as follows:
 - (a) HORIZONTAL SWEEP: 2 μ s/div.
 - (b) TRIGGER MODE: auto, rising edge
 - (c) TRIGGER SOURCE: Ch1.
 - (d) CH1: 50 mV/div, AC coupled, bandwidth 20 MHz
3. Use “Tip & Barrel” technique shown in [Figure 3](#) to probe VOUT1 and VOUT2 during test procedure.

6.3 Measuring Improved Light Load Efficiency

1. All jumper modifications should be done with no power applied to the EVM
2. SKIPSEL1 and SKIPSEL2 allow the user to select how the EVM operates when in light load. [Table 3](#) describes each possible selection.

Table 3. SKIPSEL1 or SKIPSEL2 (jumpers JP1 and JP4) Selections

JUMPER LOCATION	MODE	DESCRIPTION
CCM (1 and 2 shorted)	CCM	EVM remains in continuous current mode
AS (3 and 4 shorted) default	Auto-skip	EVM enters auto skip mode at light load, audible noise may be heard.
OOA_L (5 and 6 shorted)	OOA (<400 kHz)	EVM enters skip mode with no audible noise
OOA_H (7 and 8 shorted)	OOA (>400 kHz)	Not recommended

3. Once a mode has been selected efficiency and regulation measurements may be retaken. Repeat steps 3 to 11 of section [Section 6.1](#). The engineer should reduce the step current when the output is less than 1 A. [Section 7](#) shows typical data for the various modes of operation

6.4 Control Architecture and OVP Select

1. All jumper modifications should be done with no power applied to the EVM.
2. The FUNC jumper (JP2) allows the user to select the control architecture the EVM uses to control the output. It also enables or disables the OVP function. [Table 4](#) describes each possible selection.

Table 4. FUNC (jumper JP2) Selections

JUMPER LOCATION	MODE
CMODE_ON (1 and 2 shorted) default	Current mode control and OVP enabled
DCAP_OFF (3 and 4 shorted)	D-Cap mode control and OVP disabled
DCAP_ON (5 and 6 shorted)	D-Cap mode control and OVP enabled
CMODE_OFF (7 and 8 shorted)	Current mode control and OVP disabled

3. Once a mode has been selected efficiency and regulation measurements may be retaken. Repeat steps 3 to 11 of section [Section 6.1](#). The engineer should reduce the step current when the output is less than 1 A. [Section 7](#) shows typical data for the various modes of operation

6.5 Over Current Trip Level and Output Discharge Select

1. All jumper modifications should be done with no power applied to the EVM.
2. The TRIP jumper (JP3) allows the user to select the voltage level used by the EVM to implement current limit. It also enables or disables the output discharge function. [Table 5](#) describes each possible selection.

Table 5. TRIP (JP3) Selections

JUMPER LOCATION	MODE
UL_D-ON (1 and 2 shorted)	Over current uses ultra low voltage threshold (31 mV typical) and output discharge is enabled
UL_OFF (3 and 4 shorted)	Over current uses ultra low voltage threshold (31 mV typical) and output discharge is disabled
LV_OFF (5 and 6 shorted)	Over current uses low voltage threshold (60 mV typical) and output discharge is disabled
LV_D-ON (7 and 8 shorted) default	Over current uses low voltage threshold (60 mV typical) and output discharge is enabled

3. Once a mode has been selected efficiency and regulation measurements may be retaken. Repeat steps 3 to 11 of section [Section 6.1](#). The engineer should reduce the step current when the output is less than 1 A. [Section 7](#) shows typical data for the various modes of operation

7 Performance Data and Typical Characteristic Curves

7.1 Efficiency

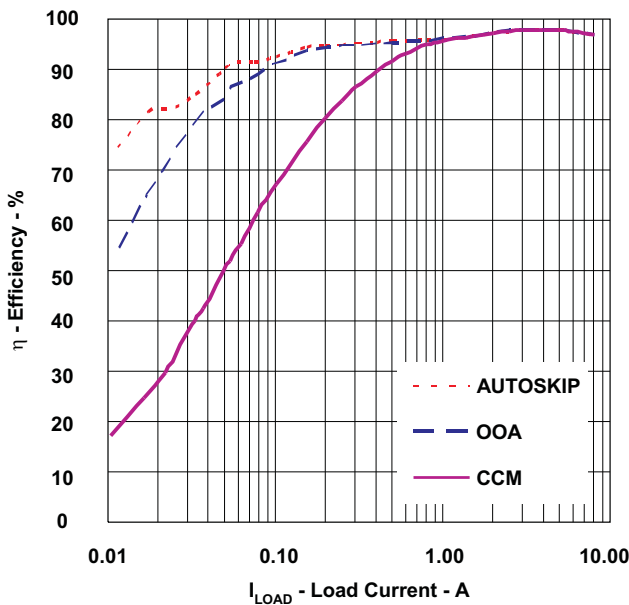

Figure 4. Efficiency, 12 V_{IN}, 5.0-V Output

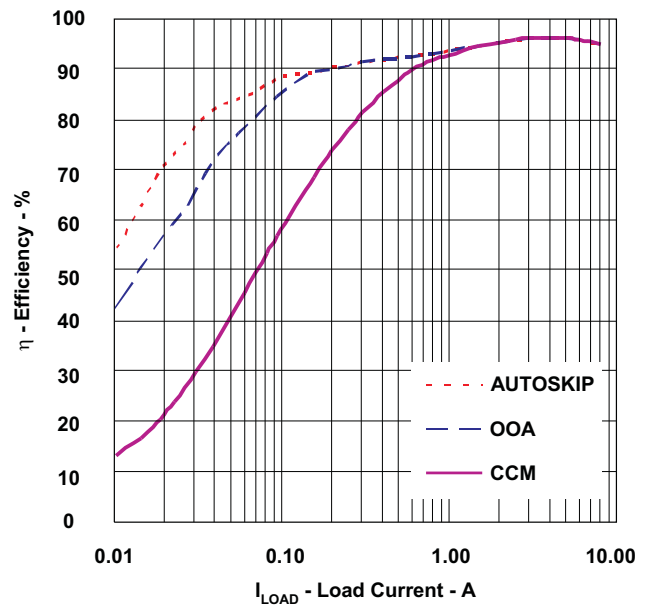

Figure 5. Efficiency, 12 V_{IN}, 3.3-V Output

7.2 Load Regulation

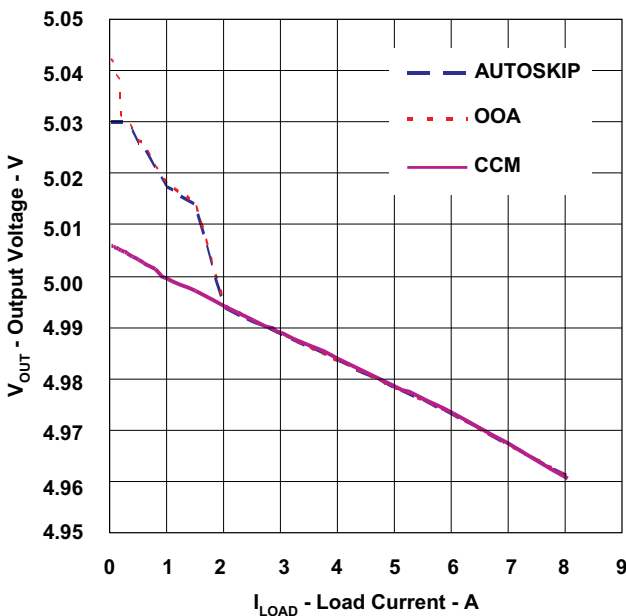

Figure 6. 12 V_{IN}, 5.0-V Load Regulation

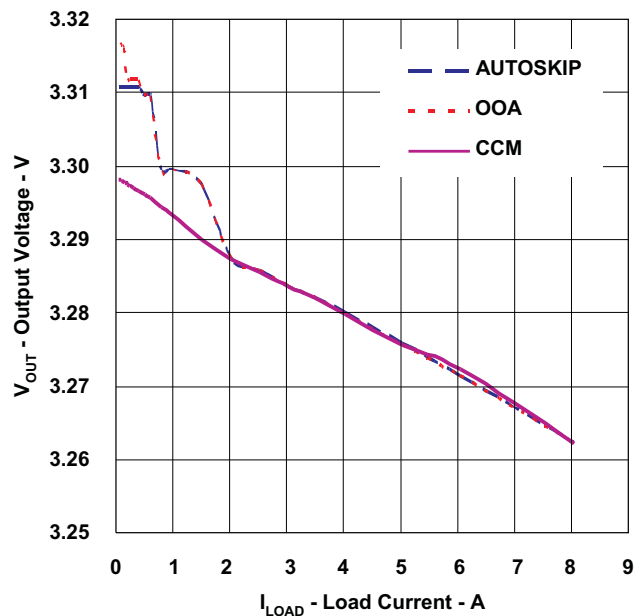

Figure 7. 12 V_{IN}, 3.3-V Load Regulation

7.3 Bode Plot

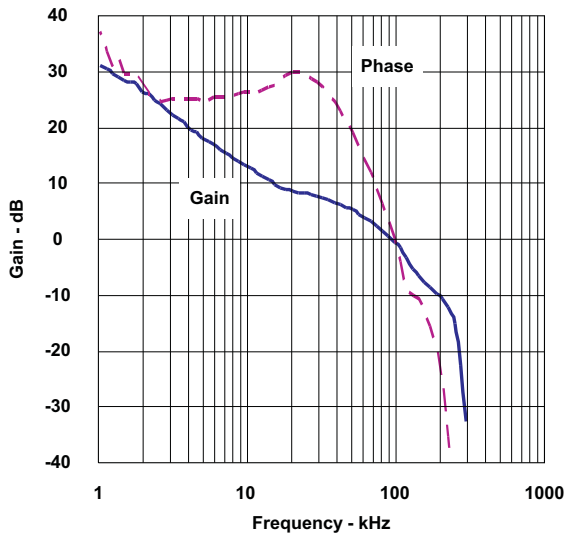

Figure 8. CCM mode 5-V Loop Response Gain and Phase, $f_{CO} = 95$ kHz, $PM = 48^\circ$

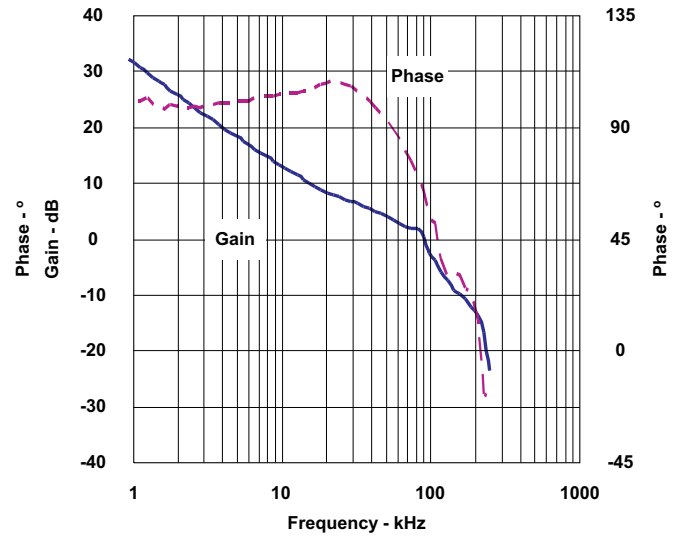

Figure 9. CCM mode 3.3-V Loop Response Gain and Phase, $f_{CO} = 90$ kHz, $PM = 63^\circ$

7.4 Transient Response

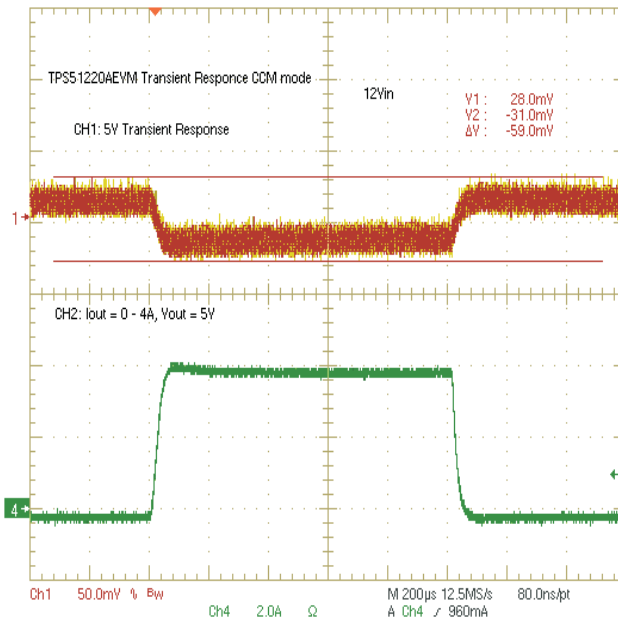

Figure 10. 5-V CCM Mode Load Transient

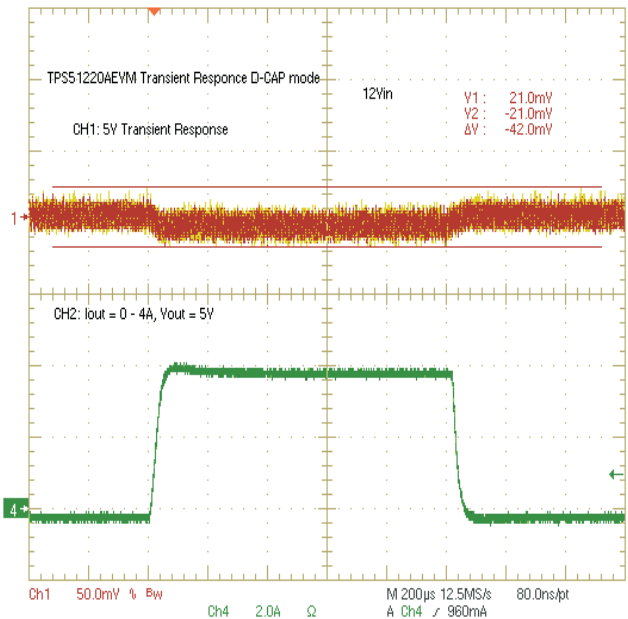

Figure 11. 5-V D-CAP Mode Load Transient

7.5 Output Ripple and Switch Node

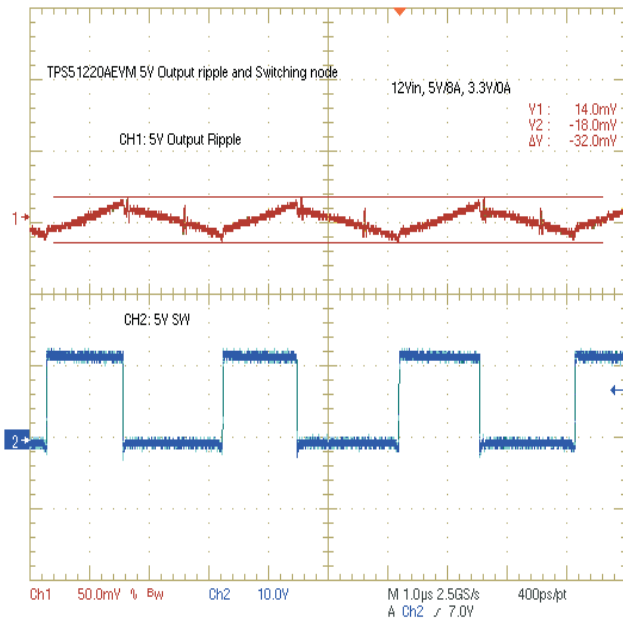

Figure 12. 5-V CCM Mode Output Ripple and Switch Node

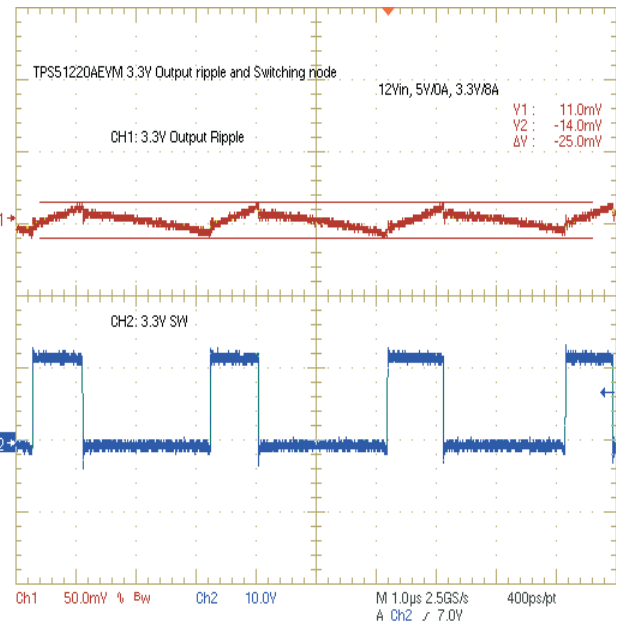

Figure 13. 3.3-V CCM Mode Output Ripple

7.6 Turn-On Waveform

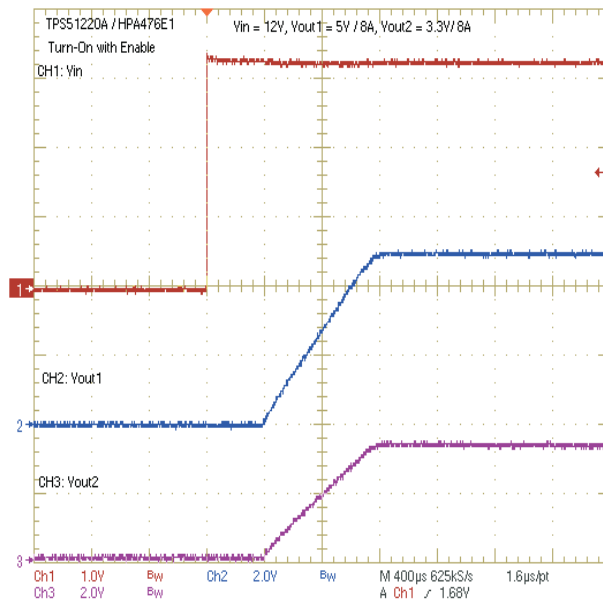

Figure 14. Enable Turn-On Waveform

7.7 Turn-Off Waveform

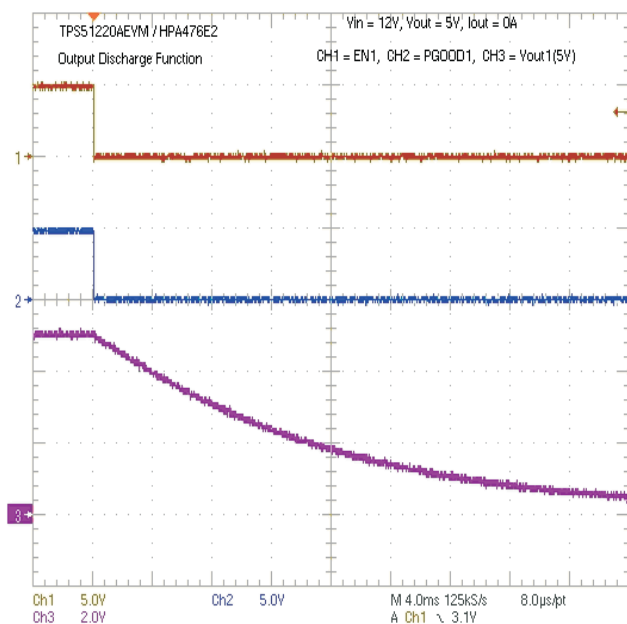

Figure 15. Enable Turn-Off With Discharge Waveform

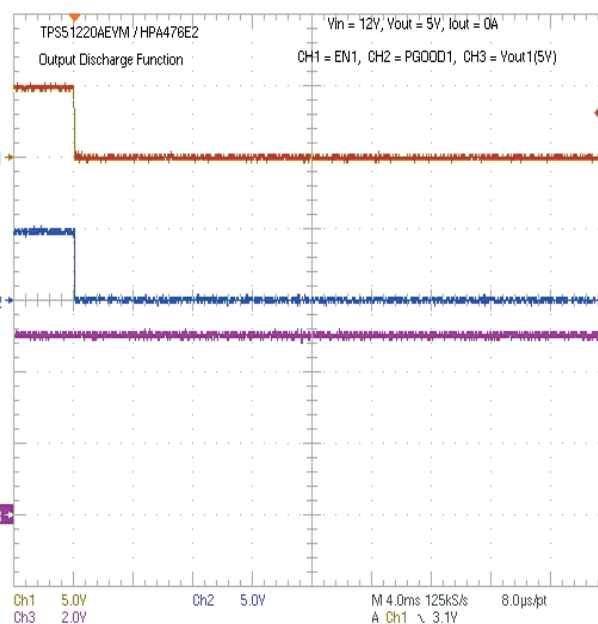

Figure 16. Enable Turn-Off Without Discharge Waveform

8 EVM Assembly Drawing and PCB Layout

The following figures (Figure 17 through Figure 22) show the design of the TPS51220A EVM-476 printed circuit board. The PCB is 0.062" thick. It uses four layers of copper. The two internal layers are 2-oz copper while the external layers are 1-oz copper.

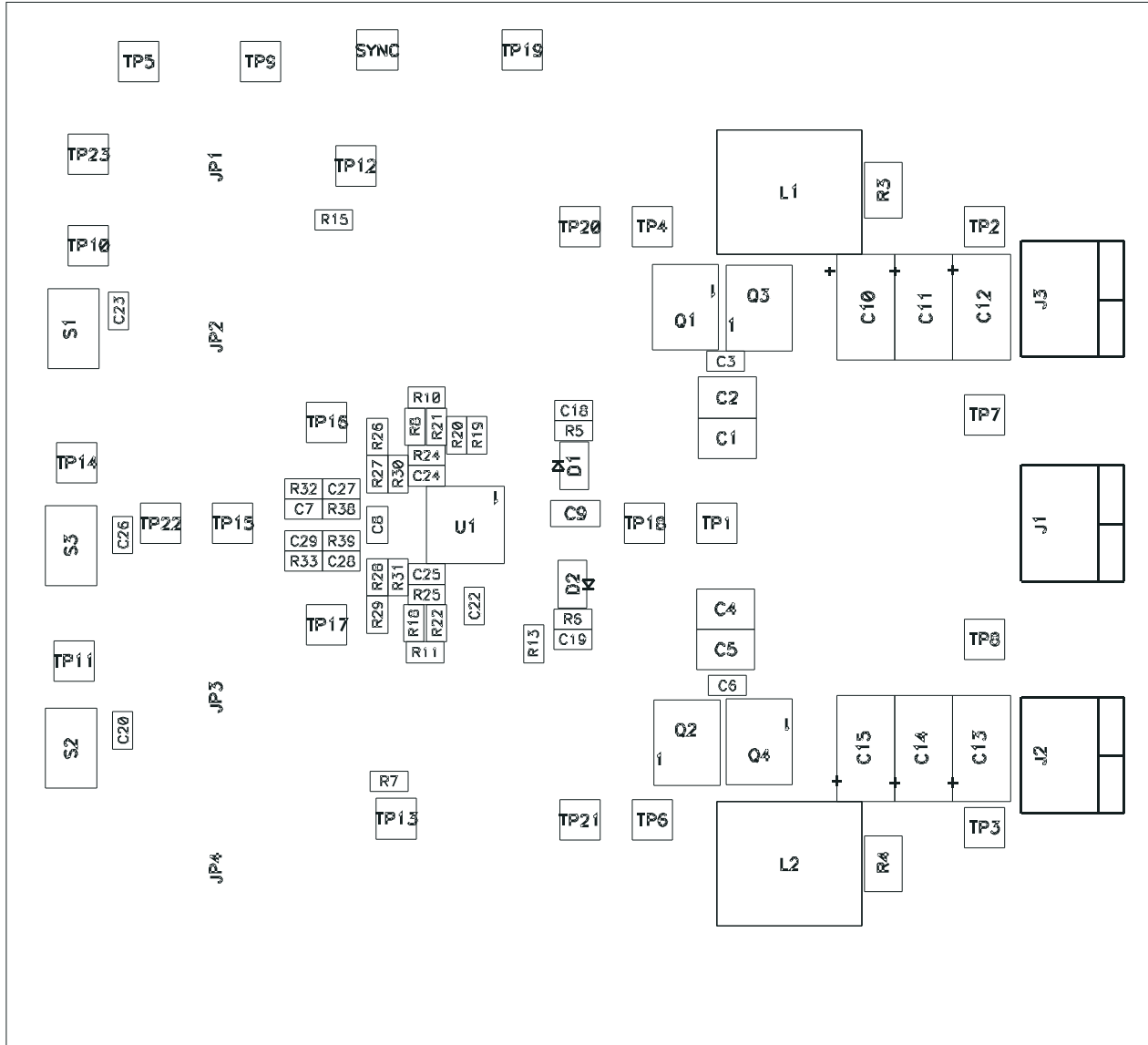

Figure 17. Top Layer Assembly Drawing (Top view)

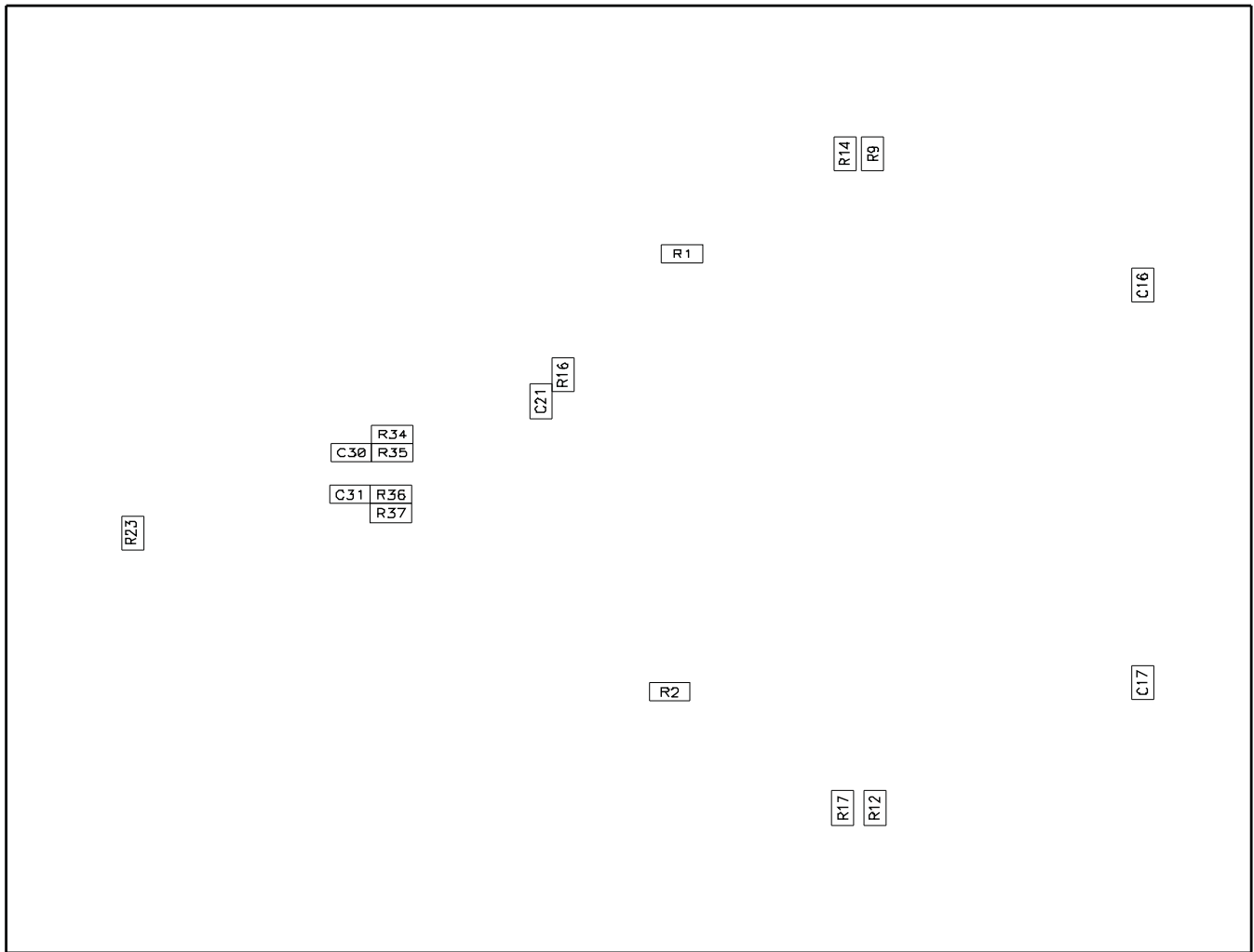

Figure 18. Bottom Assembly Drawing (Top view)

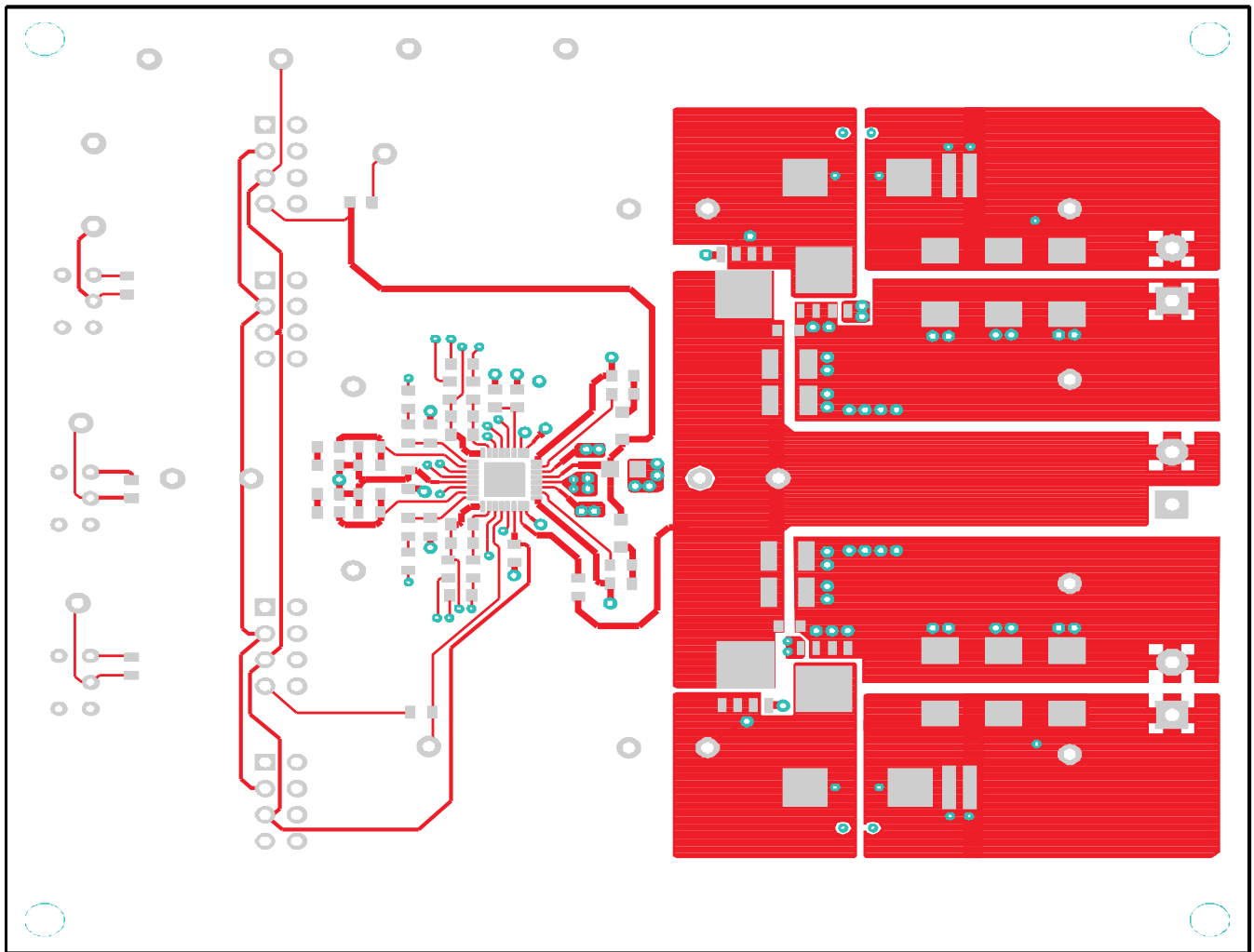

Figure 19. Top Copper (Top View)

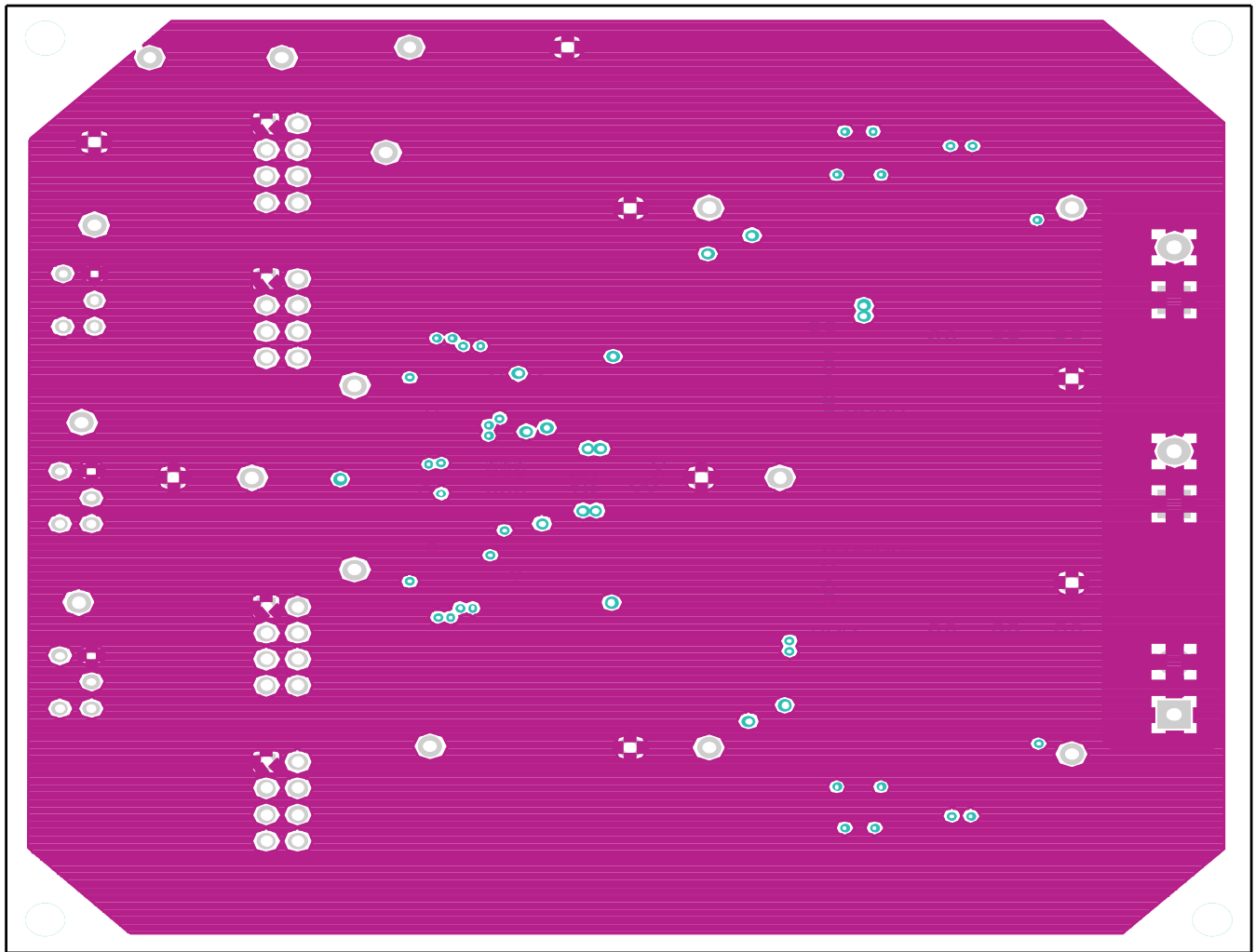

Figure 20. Internal Layer 1 (Top View)

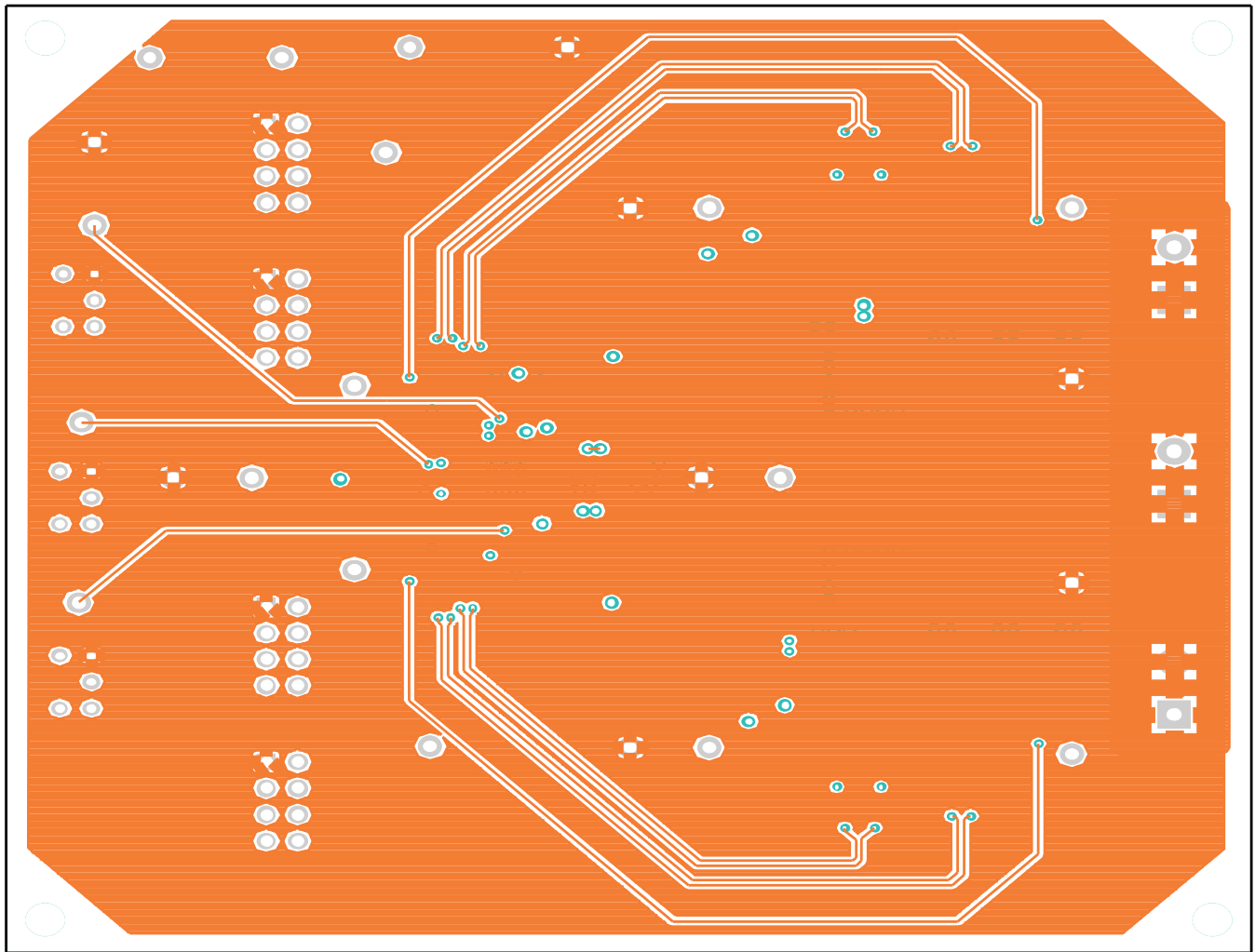

Figure 21. Internal Layer 2 (Top View)

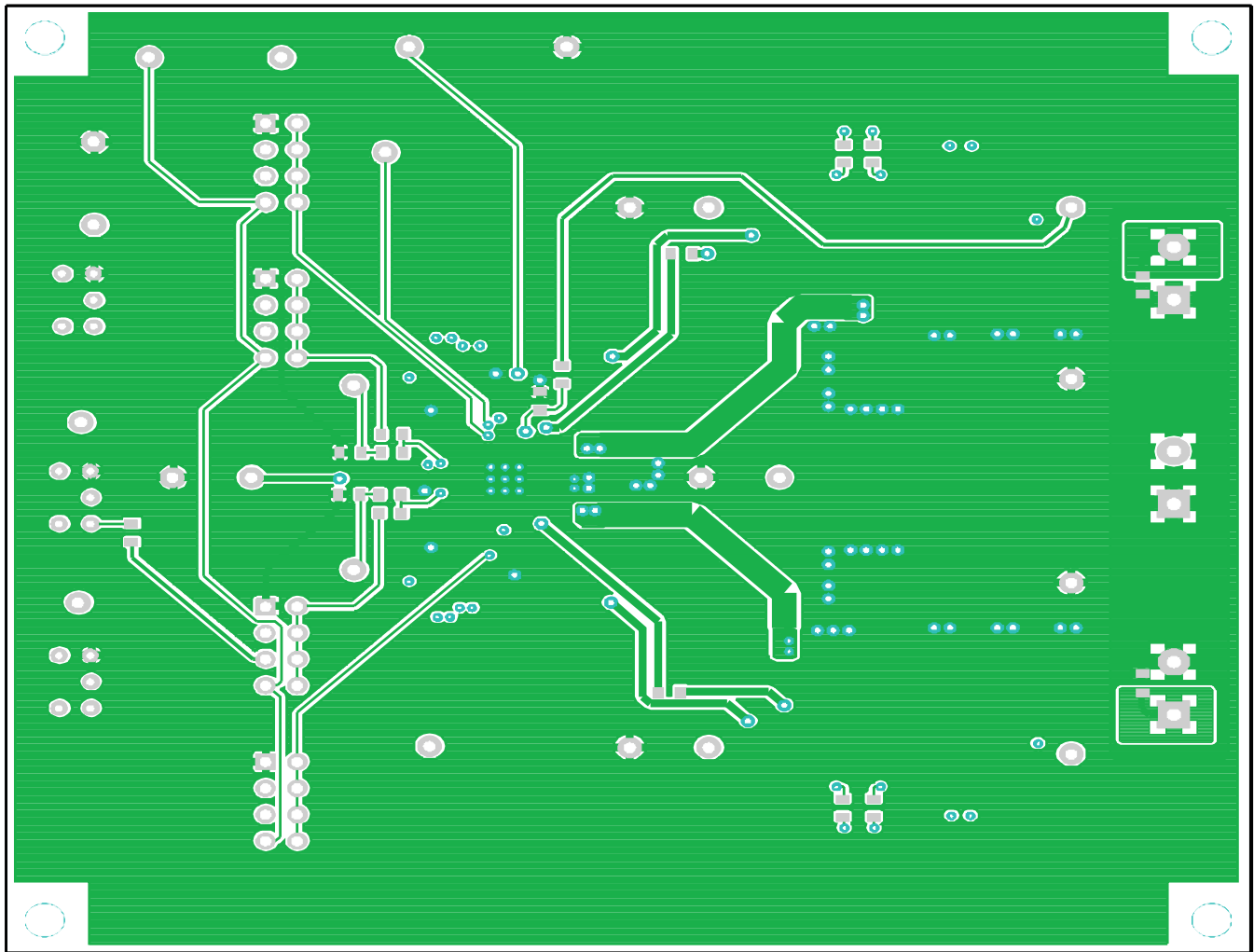

Figure 22. Bottom Copper (Top View)

9 List of Materials

Table 6. EVM Components List According to Schematic Shown in Figure 1

QTY	REFDES	DESCRIPTION	MFR	PART NUMBER
4	C1, C2, C4, C5	Capacitor, ceramic, 10 μ F, 25 V, X7R, \pm 10%, 1210	muRata	GRM32DR71E106K
2	C10, C11	Capacitor, POS-CAP, 330 μ F, 6.3 V, 18 m Ω , 20%	SANYO	6TPE330MIL
2	C14, C15	Capacitor, POS-CAP, 470 μ F, 4.0 V, 15 m Ω , 20%	SANYO	4TPE470MFL
3	C16, C17, C21	Capacitor, ceramic, 0.01 μ F, 50 V, X7R, \pm 10%, 0603	Std	Std
4	C20, C23, C26, C27	Capacitor, ceramic, 100 pF, 50 V, C0G, \pm 5%, 0603	Std	Std
1	C22	Capacitor, ceramic, 2.2 μ F, 6.3 V, X5R, \pm 10%, 0603	Std	Std
1	C28	Capacitor, ceramic, 47 pF, 50 V, C0G, \pm 5%. 0603	Std	Std
6	C3, C6, C18, C19, C24, C25	Capacitor, ceramic, 0.1 μ F, 50 V, X7R, \pm 10%, 0603	Std	Std
1	C8	Capacitor, ceramic, 0.22 μ F, 25 V, X7R, \pm 10%, 0603	Std	Std
1	C9	Capacitor, ceramic, 10 μ F, 6.3 V, X5R, \pm 10%, 0805	TDK	C2012X5R0J106K
2	D1, D2	Diode, Schottky, 40 V, 30 mA, SOD-323	Rohm	RB751x-40
2	L1, L2	Inductor, 3.3- μ H, 12 A	Vishay	IHLP5050CEER3R3
2	Q1, Q2	MOSFET, N-ch, 30 V, 14 A, 9.7 m Ω	TI	CSD17307Q5A
2	Q3, Q4	MOSFET, N-ch, 30 V, 21 A, 4.5 m Ω	TI	CSD17310Q5A
11	R1, R2, R9, R12, R13, R14, R16, R17, R23, R34, R37	Resistor, chip, 0 Ω , 1/16 W, \pm 5%, 0603	Std	Std
1	R20	Resistor, chip, 300 k Ω , 1/16 W, \pm 1%, 0603	Std	Std
1	R21	Resistor, chip, 8.20 k Ω , 1/16 W, \pm 1%, 0603	Std	Std
1	R22	Resistor, chip, 7.50 k Ω , 1/16 W, \pm 1%, 0603	Std	Std
2	R24, R25	Resistor, chip, 5.60 k Ω , 1/16 W, \pm 1%, 0603	Std	Std
2	R26, R29	Resistor, chip, 51.1 Ω , 1/16 W, \pm 1%, 0603	Std	Std
1	R27	Resistor, chip, 120 k Ω , 1/16 W, \pm 1%, 0603	Std	Std
1	R28	Resistor, chip, 62.0 k Ω , 1/16 W, \pm 1%, 0603	Std	Std
1	R30	Resistor, chip, 30.0 k Ω , 1/16 W, \pm 1%, 0603	Std	Std
1	R31	Resistor, chip, 27.0 k Ω , 1/16 W, \pm 1%, 0603	Std	Std
1	R38	Resistor, chip, 15.0 k Ω , 1/16 W, \pm 1%, 0603	Std	Std
1	R39	Resistor, chip, 12.0 k Ω , 1/16 W, \pm 1%, 0603	Std	Std
2	R5, R6	Resistor, chip, 15.4 Ω , 1/16 W, \pm 1%, 0603	Std	Std
2	R7, R15	Resistor, chip, 470 k Ω , 1/16 W, \pm 1%, 0603	Std	Std
1	U1	Fixed frequency 99% duty cycle, dual buck controller	TI	TPS51220ARTV

Evaluation Board/Kit Important Notice

Texas Instruments (TI) provides the enclosed product(s) under the following conditions:

This evaluation board/kit is intended for use for **ENGINEERING DEVELOPMENT, DEMONSTRATION, OR EVALUATION PURPOSES ONLY** and is not considered by TI to be a finished end-product fit for general consumer use. Persons handling the product(s) must have electronics training and observe good engineering practice standards. As such, the goods being provided are not intended to be complete in terms of required design-, marketing-, and/or manufacturing-related protective considerations, including product safety and environmental measures typically found in end products that incorporate such semiconductor components or circuit boards. This evaluation board/kit does not fall within the scope of the European Union directives regarding electromagnetic compatibility, restricted substances (RoHS), recycling (WEEE), FCC, CE or UL, and therefore may not meet the technical requirements of these directives or other related directives.

Should this evaluation board/kit not meet the specifications indicated in the User's Guide, the board/kit may be returned within 30 days from the date of delivery for a full refund. **THE FOREGOING WARRANTY IS THE EXCLUSIVE WARRANTY MADE BY SELLER TO BUYER AND IS IN LIEU OF ALL OTHER WARRANTIES, EXPRESSED, IMPLIED, OR STATUTORY, INCLUDING ANY WARRANTY OF MERCHANTABILITY OR FITNESS FOR ANY PARTICULAR PURPOSE.**

The user assumes all responsibility and liability for proper and safe handling of the goods. Further, the user indemnifies TI from all claims arising from the handling or use of the goods. Due to the open construction of the product, it is the user's responsibility to take any and all appropriate precautions with regard to electrostatic discharge.

EXCEPT TO THE EXTENT OF THE INDEMNITY SET FORTH ABOVE, NEITHER PARTY SHALL BE LIABLE TO THE OTHER FOR ANY INDIRECT, SPECIAL, INCIDENTAL, OR CONSEQUENTIAL DAMAGES.

TI currently deals with a variety of customers for products, and therefore our arrangement with the user **is not exclusive.**

TI assumes **no liability for applications assistance, customer product design, software performance, or infringement of patents or services described herein.**

Please read the User's Guide and, specifically, the Warnings and Restrictions notice in the User's Guide prior to handling the product. This notice contains important safety information about temperatures and voltages. For additional information on TI's environmental and/or safety programs, please contact the TI application engineer or visit www.ti.com/esh.

No license is granted under any patent right or other intellectual property right of TI covering or relating to any machine, process, or combination in which such TI products or services might be or are used.

FCC Warning

This evaluation board/kit is intended for use for **ENGINEERING DEVELOPMENT, DEMONSTRATION, OR EVALUATION PURPOSES ONLY** and is not considered by TI to be a finished end-product fit for general consumer use. It generates, uses, and can radiate radio frequency energy and has not been tested for compliance with the limits of computing devices pursuant to part 15 of FCC rules, which are designed to provide reasonable protection against radio frequency interference. Operation of this equipment in other environments may cause interference with radio communications, in which case the user at his own expense will be required to take whatever measures may be required to correct this interference.

EVM Warnings and Restrictions

It is important to operate this EVM within the input voltage range of xxx VAC to xxx VAC and the output voltage range of xxx A .

Exceeding the specified input range may cause unexpected operation and/or irreversible damage to the EVM. If there are questions concerning the input range, please contact a TI field representative prior to connecting the input power.

Applying loads outside of the specified output range may result in unintended operation and/or possible permanent damage to the EVM. Please consult the EVM User's Guide prior to connecting any load to the EVM output. If there is uncertainty as to the load specification, please contact a TI field representative.

During normal operation, some circuit components may have case temperatures greater than xxx°C. The EVM is designed to operate properly with certain components above xxx° C as long as the input and output ranges are maintained. These components include but are not limited to linear regulators, switching transistors, pass transistors, and current sense resistors. These types of devices can be identified using the EVM schematic located in the EVM User's Guide. When placing measurement probes near these devices during operation, please be aware that these devices may be very warm to the touch.

Mailing Address: Texas Instruments, Post Office Box 655303, Dallas, Texas 75265
Copyright © 2011, Texas Instruments Incorporated

IMPORTANT NOTICE

Texas Instruments Incorporated and its subsidiaries (TI) reserve the right to make corrections, modifications, enhancements, improvements, and other changes to its products and services at any time and to discontinue any product or service without notice. Customers should obtain the latest relevant information before placing orders and should verify that such information is current and complete. All products are sold subject to TI's terms and conditions of sale supplied at the time of order acknowledgment.

TI warrants performance of its hardware products to the specifications applicable at the time of sale in accordance with TI's standard warranty. Testing and other quality control techniques are used to the extent TI deems necessary to support this warranty. Except where mandated by government requirements, testing of all parameters of each product is not necessarily performed.

TI assumes no liability for applications assistance or customer product design. Customers are responsible for their products and applications using TI components. To minimize the risks associated with customer products and applications, customers should provide adequate design and operating safeguards.

TI does not warrant or represent that any license, either express or implied, is granted under any TI patent right, copyright, mask work right, or other TI intellectual property right relating to any combination, machine, or process in which TI products or services are used. Information published by TI regarding third-party products or services does not constitute a license from TI to use such products or services or a warranty or endorsement thereof. Use of such information may require a license from a third party under the patents or other intellectual property of the third party, or a license from TI under the patents or other intellectual property of TI.

Reproduction of TI information in TI data books or data sheets is permissible only if reproduction is without alteration and is accompanied by all associated warranties, conditions, limitations, and notices. Reproduction of this information with alteration is an unfair and deceptive business practice. TI is not responsible or liable for such altered documentation. Information of third parties may be subject to additional restrictions.

Resale of TI products or services with statements different from or beyond the parameters stated by TI for that product or service voids all express and any implied warranties for the associated TI product or service and is an unfair and deceptive business practice. TI is not responsible or liable for any such statements.

TI products are not authorized for use in safety-critical applications (such as life support) where a failure of the TI product would reasonably be expected to cause severe personal injury or death, unless officers of the parties have executed an agreement specifically governing such use. Buyers represent that they have all necessary expertise in the safety and regulatory ramifications of their applications, and acknowledge and agree that they are solely responsible for all legal, regulatory and safety-related requirements concerning their products and any use of TI products in such safety-critical applications, notwithstanding any applications-related information or support that may be provided by TI. Further, Buyers must fully indemnify TI and its representatives against any damages arising out of the use of TI products in such safety-critical applications.

TI products are neither designed nor intended for use in military/aerospace applications or environments unless the TI products are specifically designated by TI as military-grade or "enhanced plastic." Only products designated by TI as military-grade meet military specifications. Buyers acknowledge and agree that any such use of TI products which TI has not designated as military-grade is solely at the Buyer's risk, and that they are solely responsible for compliance with all legal and regulatory requirements in connection with such use.

TI products are neither designed nor intended for use in automotive applications or environments unless the specific TI products are designated by TI as compliant with ISO/TS 16949 requirements. Buyers acknowledge and agree that, if they use any non-designated products in automotive applications, TI will not be responsible for any failure to meet such requirements.

Following are URLs where you can obtain information on other Texas Instruments products and application solutions:

Products

Audio	www.ti.com/audio
Amplifiers	amplifier.ti.com
Data Converters	dataconverter.ti.com
DLP® Products	www.dlp.com
DSP	dsp.ti.com
Clocks and Timers	www.ti.com/clocks
Interface	interface.ti.com
Logic	logic.ti.com
Power Mgmt	power.ti.com
Microcontrollers	microcontroller.ti.com
RFID	www.ti-rfid.com
RF/IF and ZigBee® Solutions	www.ti.com/lprf

Applications

Communications and Telecom	www.ti.com/communications
Computers and Peripherals	www.ti.com/computers
Consumer Electronics	www.ti.com/consumer-apps
Energy and Lighting	www.ti.com/energy
Industrial	www.ti.com/industrial
Medical	www.ti.com/medical
Security	www.ti.com/security
Space, Avionics and Defense	www.ti.com/space-avionics-defense
Transportation and Automotive	www.ti.com/automotive
Video and Imaging	www.ti.com/video
Wireless	www.ti.com/wireless-apps

TI E2E Community Home Page

e2e.ti.com

Mailing Address: Texas Instruments, Post Office Box 655303, Dallas, Texas 75265
Copyright © 2011, Texas Instruments Incorporated