

CXM-14 COB Arrays

White LED



Table of Contents

- Technology Overview2
- Test Specifications2
- Chromaticity Bins3
- Product Ordering & Shipping Part Numbers4
- Part Numbers (AA00) 5
- Part Numbers (AC00)6
- Operating Characteristics ..7
- Optical and Electrical Characteristics.....8
- Spectra9
- Mechanical Dimensions .. 10
- Packaging Information ... 11
- Handling Notes 12

Features:

- High lumen output and efficacy typical
 - Over 2250 lm, 130 LPW @ 3000K, 25°C
 - Over 2460 lm, 142 LPW @ 5000K, 25°C
- Complete CCT range 2700K, 3000K, 3500K, 4000K, 5000K and 6500K
- 80 or 90 CRI min. up to 95 min. in warm white
- 2-step and 3-step MacAdam Ellipse color binning accuracy
- Excellent optical emission uniformity and color over angle consistency
- Exceptional long term color stability
- Superior thermal conductivity for uniform heat spreading
- Environmentally friendly: RoHS and REACH compliant
- 

Applications

- | | |
|--|--|
| <ul style="list-style-type: none"> • Spotlights/Track Lights • Downlights • Shop Lighting • Hospitality Lighting | <ul style="list-style-type: none"> • Architectural and Specialty • Street Lighting • Parking Lot and Area Lighting • Tunnel Lighting |
|--|--|

Technology Overview

Luminus XNova™ Chip-on-Board (COB) LED series offers a complete lighting class solution designed for high performance illumination applications. The selection covers a wide lumen range from less than 400lm to over 10,000lm, all major color temperatures and can deliver color rendering greater than 97 at 2700K and 3000K and R9 equal to 95. These breakthroughs allow illumination engineers and designers to develop lighting solutions with maximum efficacy, brightness and overall quality.

Reliability

Designed from the ground up, the XNova™ COB LED is one of the most reliable light sources in the world today. Having passed a rigorous suite of environmental and mechanical stress tests, including mechanical shock, vibration, temperature cycling and humidity. Only then are the devices qualified for use in a wide range of lighting application including some of the most demanding commercial applications. Delivered with fully qualified LM80 test data and TM21 lifetime results that certify lumen maintenance at 35,000 hours or more, XNova™ COB LEDs are ready for the toughest challenges.

UL Recognized Compliance

XNova COB arrays are tested in accordance with ANSI/UL 8750 to ensure safe operation for their intended applications.

REACH & RoHS Compliance

All LED products manufactured by Luminus are REACH and RoHS compliant and free of hazardous materials, including lead and mercury.

Understanding XNova™ COB LED Test Specifications

Every XNova™ LED is fully tested to ensure it meets the high quality standards customers have come to expect from Luminus' products.

Traceability

Each XNova COB LED is marked with a 2D bar code that contains a unique serial number. With this serial number, Luminus has the ability to provide customers with actual test data measurements for a specific LED. In addition, the 2D bar code is linked to manufacturing date codes that enables traceability of production processes and materials.

Chromaticity Bin Range

Chromaticity binning delivers color consistency for every order. Standard products are delivered with a 3-step MacAdam ellipse. This ensures color performance matching in the application. For the most demanding application, Luminus is one of only a few companies that can provide a 2-step ellipse bin. These tightly controlled, small distribution bins provide customers predictable, repeatable colors.

Testing Temperature

XNova™ COB products are measured at temperatures typical for the LED operating in the fixture. Each device is tested at 85°C junction temperature eliminating the need to scale data sheet specifications to real world situations.

Chromaticity Bin Structure

Chromaticity Bins: 1931 CIE Curve

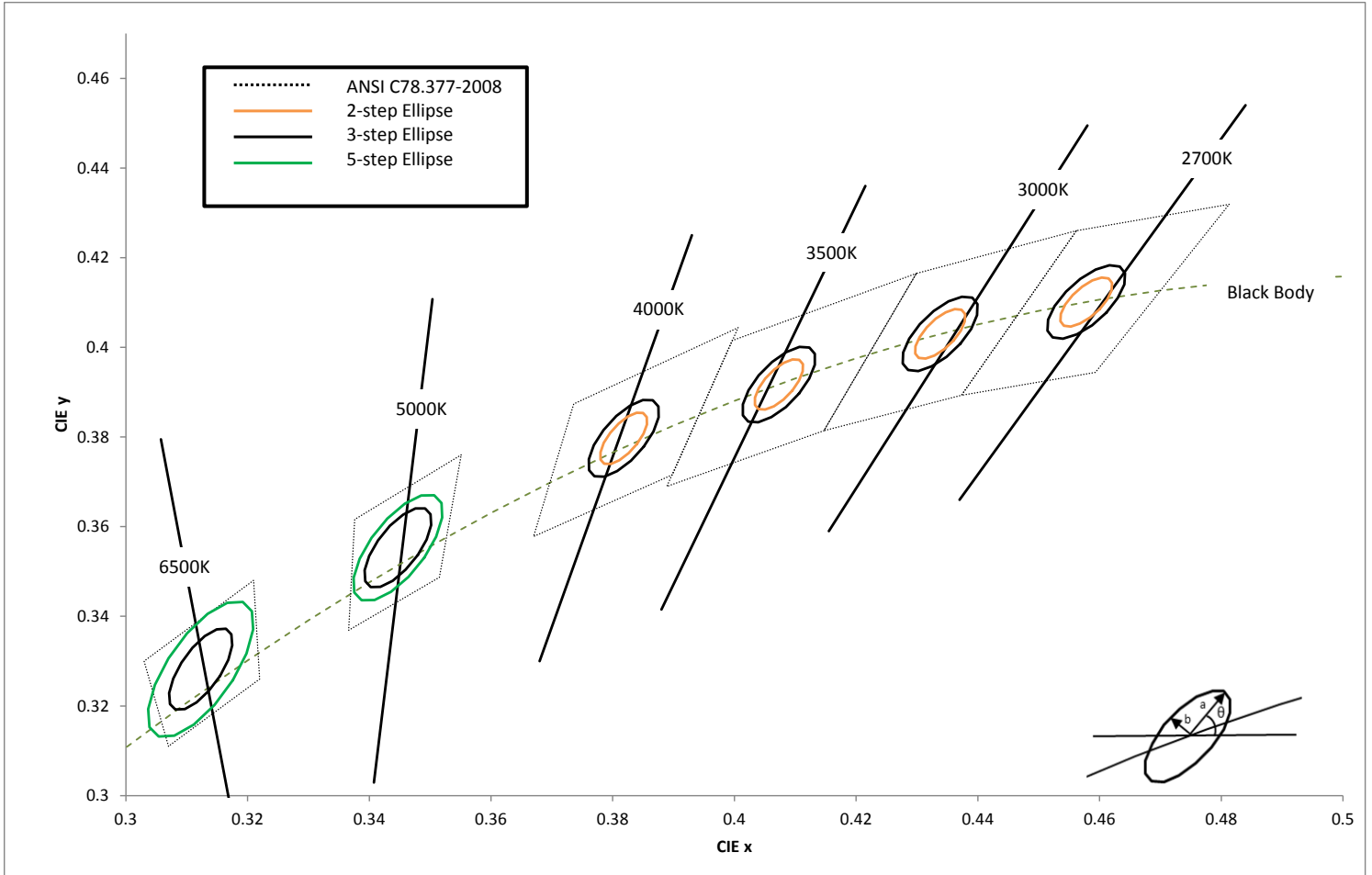

CXM-14 White Chromaticity Bins

The following tables describe the ANSI bin center points, the orientation angle for the MacAdam ellipse (θ°), and the maximum radii for the ellipses. The ANSI Bin is provided for reference.

CCT	Center Point		Angle θ°	2-step Bin		3-step Bin		5-step Bin	
	CIE _x	CIE _y		a	b	a	b	a	b
2700K	0.4578	0.4101	53.7	0.0054	0.0028	0.0081	0.0042	0.0135	0.007
3000K	0.4338	0.403	53.2	0.00556	0.00272	0.00834	0.00408	0.0139	0.0068
3500K	0.4073	0.3917	54	0.00618	0.00276	0.00927	0.00414	0.01545	0.0069
4000K	0.3818	0.3797	53.7	0.00626	0.00268	0.00939	0.00402	0.01565	0.0067
5000K	0.3447	0.3553	59.6	0.00548	0.00236	0.00822	0.00354	0.0137	0.0059
6500K	0.3123	0.3282	58.57	0.00446	0.0019	0.00669	0.00285	0.01115	0.00475

*Note: Luminus maintains a +/- 0.005 tolerance on chromaticity (CIE_x and CIE_y) measurements.

Product Ordering and Shipping Part Number Nomenclature

All CXM-14 products are packaged and labeled with part numbers as outlined in the table on page 5 and 6. For flux bins, Luminus may choose to supply a higher flux bin than the part number ordered of that is the best available solution. If only the specific flux bin is required please specify. Also, Luminus will include any smaller chromaticity bin that is contained in the larger bin as part of the ordered part. When shipped, each package will contain only a single flux and chromaticity bin. The part number designation is as follows:

CXM-14

CXM — 14 — NN — XX — 36 — QQPP — FG — W

Product Family	Light Emitting Surface Diameter	Color Temperature	Color Rendering Index (CRI)	Voltage (typical)	Package Configurator	Flux Bin	Chromaticity Bin
CXM: Chip on Board, XNova, Multi-die	13.5: LES Diameter (mm)	Color See Note 1 below	CRI See Table Below	Volts	AA00	Lumens	See page 5 and 6 for bins

Note 1: NN nomenclature corresponds to the following:

27 = 2700K

30 = 3000K

35 = 3500K

40 = 4000K

50 = 5000K

65 = 6500K

Note2: AA00 is a standard-package configurator

AC00 is an alternative size substrate

Color Temperature, CRI and R9 Values

Color Temperatures	XX Value	CRI	R9
4000K, 5000K, 6500K	70	>70	-
2700K, 3000K, 3500K, 4000K, 5000K, 6500K	80	>80	>0
2700K, 3000K, 3500K, 4000K, 5000K	90	>90	>50
2700K, 3000K	95	>95	>90
4000K			>75

Note: Luminus part numbers may be accompanied by prefixes or suffixes. The most common is the "Rev01" suffix indicating a part is fully released and carries a full warranty. These additional characters may appear on shipping labels, packing slips and invoices. In all cases the basic part number described above will always be included.

CXM-14 Part Numbers (AA00)

The following tables describe products with typical flux and minimum flux measured at 480mA and specified at Tj = 85°C. The values at 25°C are calculated and shown for reference only. Luminus may choose to ship a smaller chromaticity bin as part of an order for a larger.

CCT	Output Flux (lm)		Reference	Color Rendering Index	Ordering Part Number	
	Typ. (85°C)	Min. (85°C)	Typ. (calculated) (25°C)	CRI (min.)	3-step MacAdam Ellipse	2-step MacAdam Ellipse
2700K	1,920	1,825	2,130	80	CXM-14-27-80-36-AA00-F2-3	CXM-14-27-80-36-AA00-F2-2
	1,500	1,425	1,660	90	CXM-14-27-90-36-AA00-F2-3	CXM-14-27-90-36-AA00-F2-2
	1,410	1,340	1,560	95	CXM-14-27-95-36-AA00-F2-3	CXM-14-27-95-36-AA00-F2-2
3000K	2,030	1,930	2,250	80	CXM-14-30-80-36-AA00-F2-3	CXM-14-30-80-36-AA00-F2-2
	1,720	1,635	1,910	90	CXM-14-30-90-36-AA00-F2-3	CXM-14-30-90-36-AA00-F2-2
	1,600	1,520	1,770	95	CXM-14-30-95-36-AA00-F2-3	CXM-14-30-95-36-AA00-F2-2
3500K	2,090	1,985	2,320	80	CXM-14-35-80-36-AA00-F2-3	CXM-14-35-80-36-AA00-F2-2
	1,800	1,710	2,000	90	CXM-14-35-90-36-AA00-F2-3	CXM-14-35-90-36-AA00-F2-2
	1,645	1,565	1,980	95	CXM-14-35-95-36-AA00-F2-3	CXM-14-35-95-36-AA00-F2-2
4000K	2,160	2,050	2,400	80	CXM-14-40-80-36-AA00-F2-3	CXM-14-40-80-36-AA00-F2-2
	1,870	1,775	2,070	90	CXM-14-40-90-36-AA00-F2-3	CXM-14-40-90-36-AA00-F2-2
	1,700	1,615	1,870	95	CXM-14-40-95-36-AA00-F2-3	CXM-14-40-95-36-AA00-F2-2

CCT	Output Flux (lm)		Reference	Color Rendering Index	Part Number	
	Typ. (85°C)	Min. (85°C)	Typ. (calculated) (25°C)	CRI (min.)	5-step MacAdam Ellipse	3-step MacAdam Ellipse
5000K	2,220	2,110	2,460	80	CXM-14-50-80-36-AA00-F2-5	CXM-14-50-80-36-AA00-F2-3
6500K	2,270	2,155	2,520	80	CXM-14-65-80-36-AA00-F2-5	CXM-14-65-80-36-AA00-F2-3

*Note: Luminus maintains a +/- 6% tolerance on flux measurements.

Luminus maintains a +/- 2% tolerance on CRI measurements.

CXM-14 Part Numbers (AC00)

The following tables describe products with typical flux and minimum flux measured at 480mA and specified at 85°C. The values at 25°C are calculated and shown for reference only. All product is measured and specified at 85°C junction temperature. Luminus may choose to ship a smaller chromaticity bin as part of an order for a larger.

CCT	Output Flux (lm)		Reference Typ. (calculated) (25°C)	Color Rendering Index CRI (min.)	Ordering Part Number	
	Typ. (85°C)	Min. (85°C)			3-step MacAdam Ellipse	2-step MacAdam Ellipse
2700K	1,920	1,825	2,130	80	CXM-14-27-80-36-AC00-F2-3	CXM-14-27-80-36-AC00-F2-2
	1,500	1,425	1,660	90	CXM-14-27-90-36-AC00-F2-3	CXM-14-27-90-36-AC00-F2-2
	1,410	1,340	1,560	95	CXM-14-27-95-36-AC00-F2-3	CXM-14-27-95-36-AC00-F2-2
3000K	2,030	1,930	2,250	80	CXM-14-30-80-36-AC00-F2-3	CXM-14-30-80-36-AC00-F2-2
	1,720	1,635	1,910	90	CXM-14-30-90-36-AC00-F2-3	CXM-14-30-90-36-AC00-F2-2
	1,600	1,520	1,770	95	CXM-14-30-95-36-AC00-F2-3	CXM-14-30-95-36-AC00-F2-2
3500K	2,090	1,985	2,320	80	CXM-14-35-80-36-AC00-F2-3	CXM-14-35-80-36-AC00-F2-2
	1,800	1,710	2,000	90	CXM-14-35-90-36-AC00-F2-3	CXM-14-35-90-36-AC00-F2-2
4000K	2,270	2,155	2,497	70	CXM-14-40-70-36-AC00-F2-3	CXM-14-40-70-36-AC00-F2-2
	2,160	2,050	2,400	80	CXM-14-40-80-36-AC00-F2-3	CXM-14-40-80-36-AC00-F2-2
	1,870	1,775	2,070	90	CXM-14-40-90-36-AC00-F2-3	CXM-14-40-90-36-AC00-F2-2
	1,700	1,615	1,870	95	CXM-14-40-95-36-AC00-F2-3	CXM-14-40-95-36-AC00-F2-2

CCT	Output Flux (lm)		Reference Typ. (calculated) (25°C)	Color Rendering Index CRI (min.)	Part Number	
	Typ. (85°C)	Min. (85°C)			5-step MacAdam Ellipse	3-step MacAdam Ellipse
5000K	2,330	2,215	2,565	70	CXM-14-50-70-36-AC00-F2-5	CXM-14-50-70-36-AC00-F2-3
5000K	2,220	2,110	2,460	80	CXM-14-50-80-36-AC00-F2-5	CXM-14-50-80-36-AC00-F2-3
6500K	2,385	2,265	2,625	70	CXM-14-65-70-36-AC00-F2-5	CXM-14-65-70-36-AC00-F2-3
6500K	2,270	2,155	2,520	80	CXM-14-65-80-36-AC00-F2-5	CXM-14-65-80-36-AC00-F2-3

*Note: Luminus maintains a +/- 6% tolerance on flux measurements.

Luminus maintains a +/- 2% tolerance on CRI measurements.

CXM-14 Operating Characteristics¹
Optical and Electrical Characteristics

Parameter	Symbol	Minimum	Typical	Maximum	Unit
Forward Current ²	I_f		480	1,000	mA
Forward Voltage ³	V_f	33.5	35	37.5	V
Power			17.3	40	W
Operating Case Temperature ⁴	T_c			105	°C
Light Emitting Surface Diameter	LES		13.5		mm
Thermal Resistance (junction-to-case)	Θ_{jc}	0.87			°C/W
Junction Temperature	T_j			140	°C
Viewing Angle			120		Degree

Note 1: Ratings are based on operation at a constant junction temperature of $T_j = 85^\circ\text{C}$.

Note 2: To prevent damage refer to operating conditions and derating curves for appropriate maximum operating conditions

Note 3: Voltage is rated at typical forward current. For voltage at higher drive current, refer to performance graphs.

Note 4: CXM-14 COB LEDs are designed for operation up to an absolute maximum forward drive current as specified above. Refer to the current vs. case temperature derating curves for further information.

Note 5: Caution must be taken not to stare at the light emitted from these LEDs. Under special circumstances, the high intensity could damage the eye.

CXM-14 Optical & Electrical Characteristics

Relative Output Flux vs. Forward Current @ 85°C

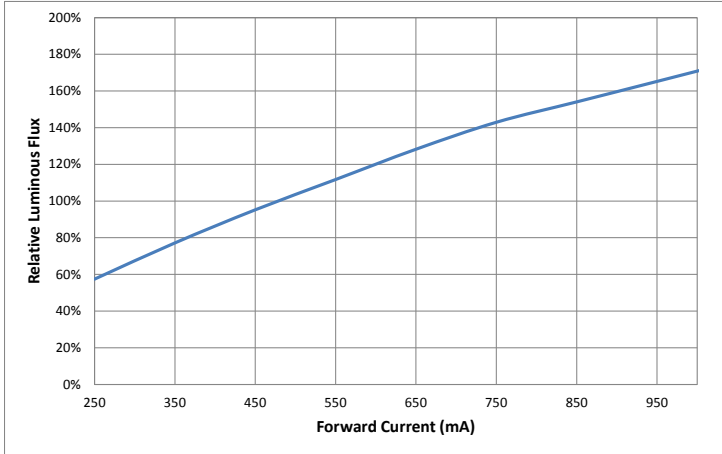

Forward Current vs. Forward Voltage @ 85°C

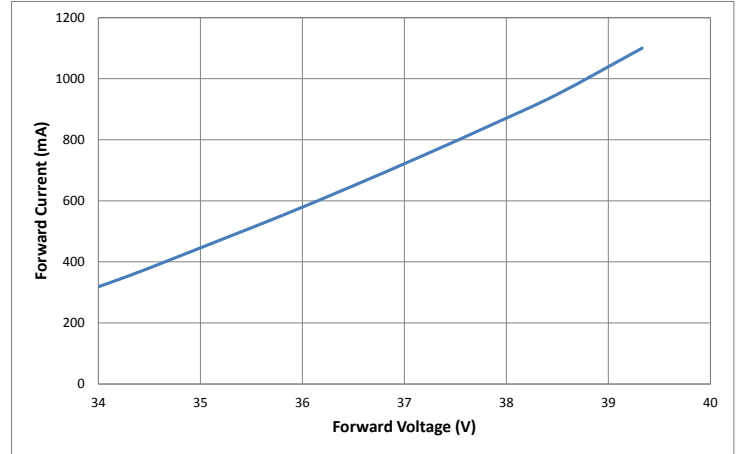

Relative Output Flux vs. Junction Temperature

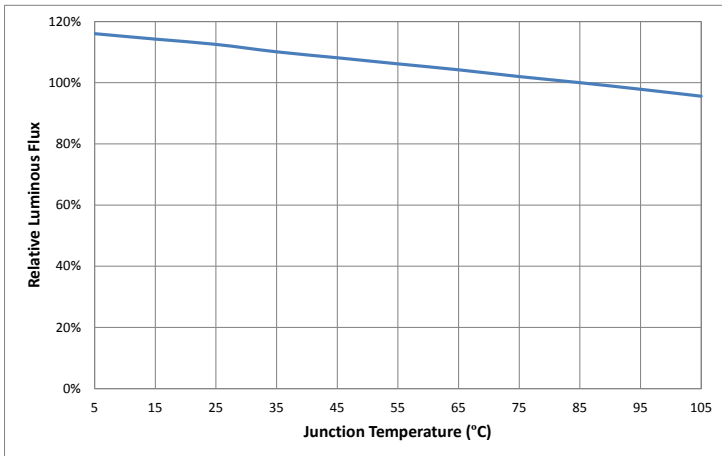

Change in Voltage vs. Junction Temperature

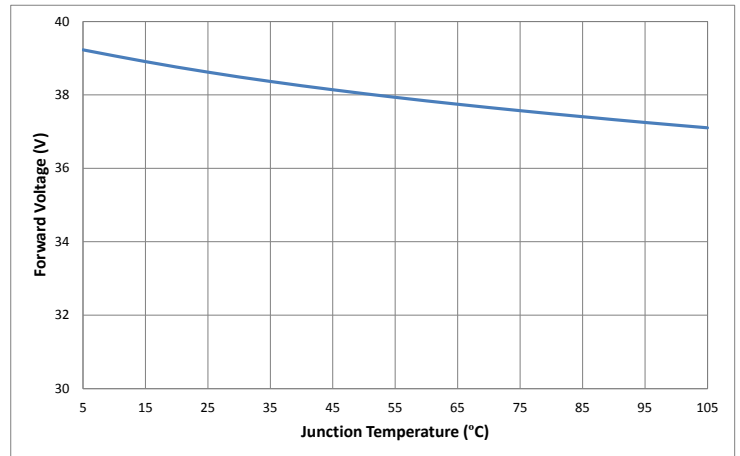

Change in CIE_x vs. Junction Temp. (3000K, 80CRI)

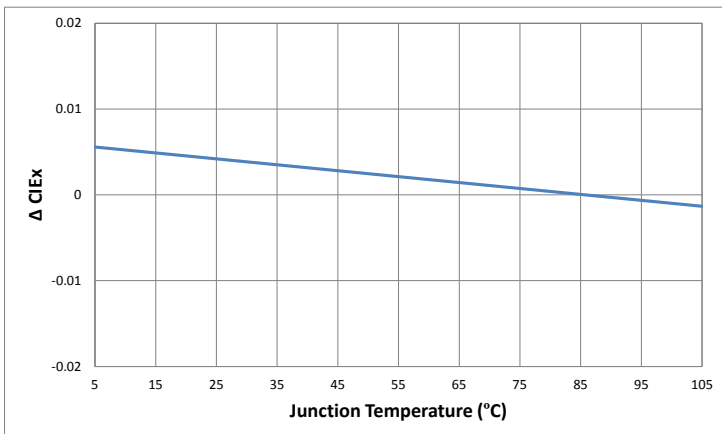

Change in CIE_y vs. Junction Temp. (3000K, 80CRI)

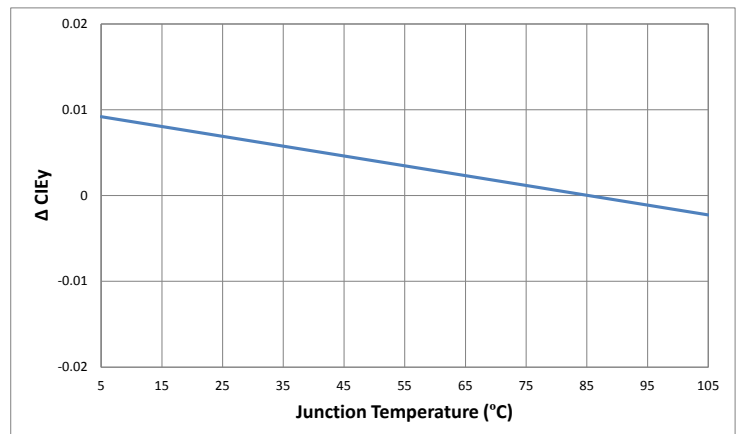

CXM-14 Optical & Electrical Characteristics

Typical Spectrum

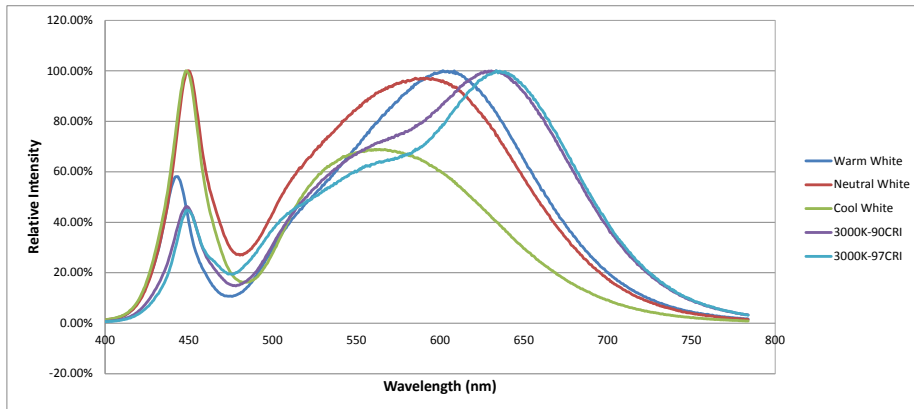

Typical Polar Radiation Pattern

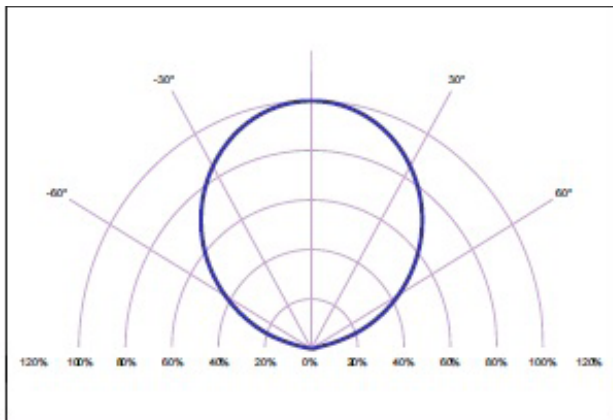

Typical Angular Radiation Pattern

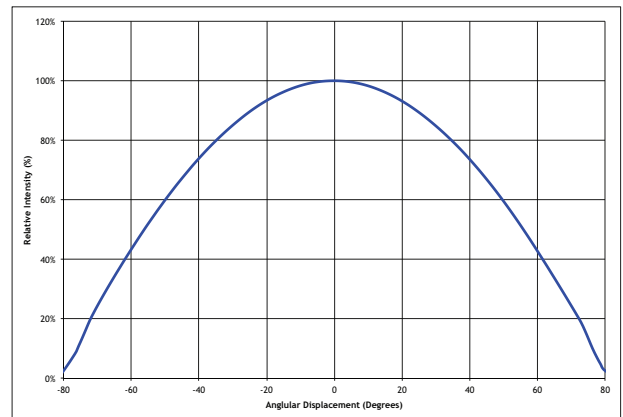

Mechanical Dimensions (AA00)

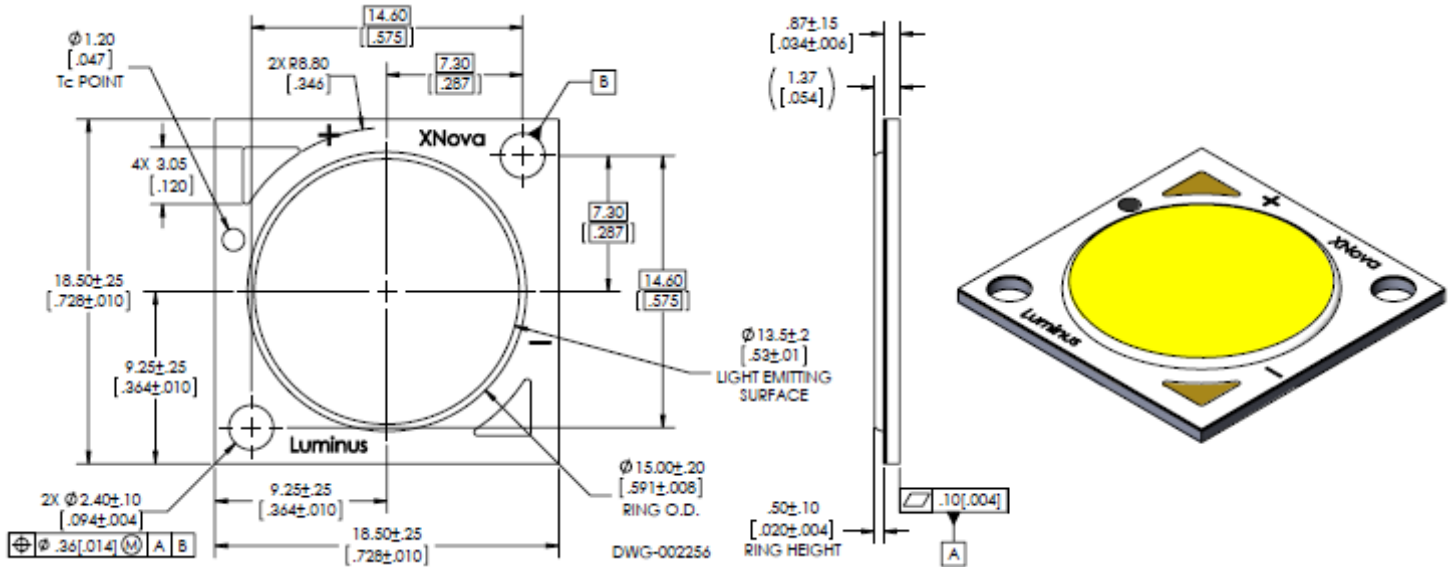

Mechanical Dimensions (AC00)

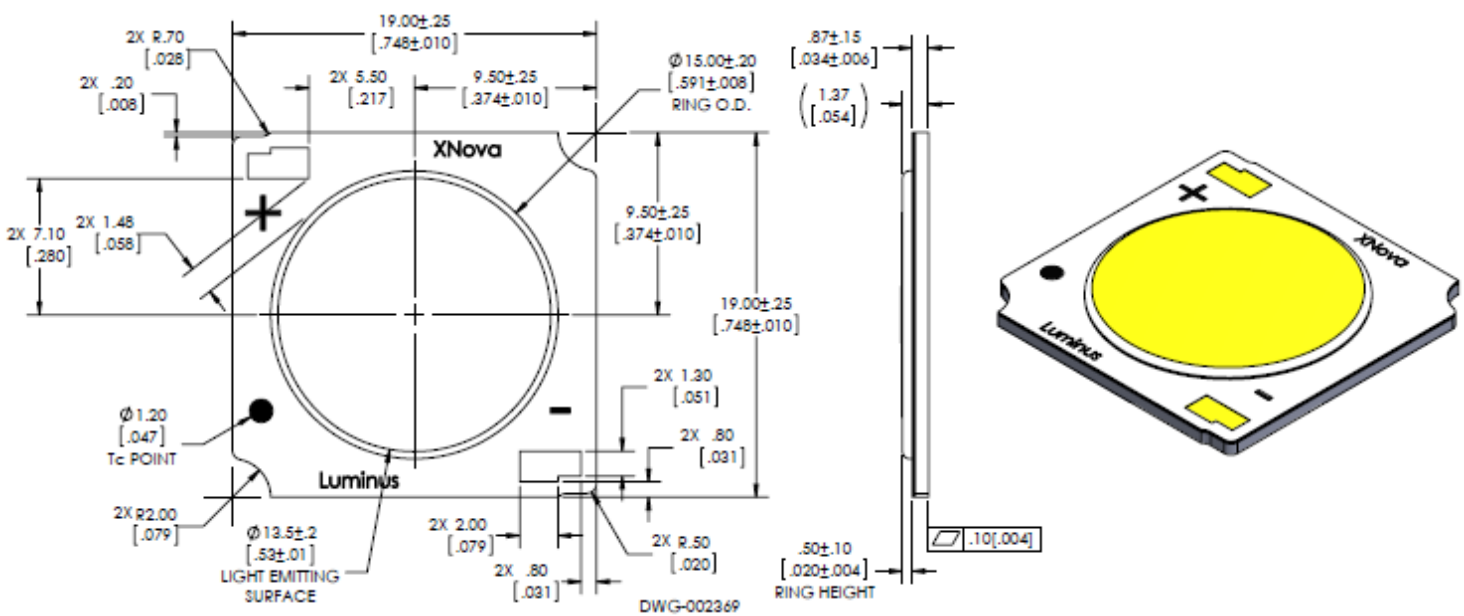

Shipping Container

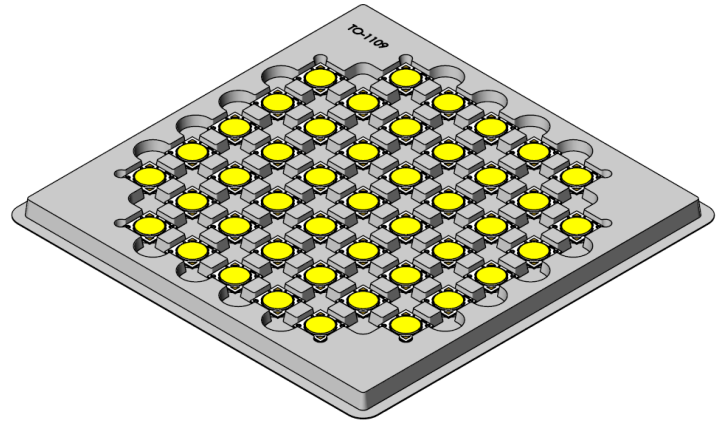
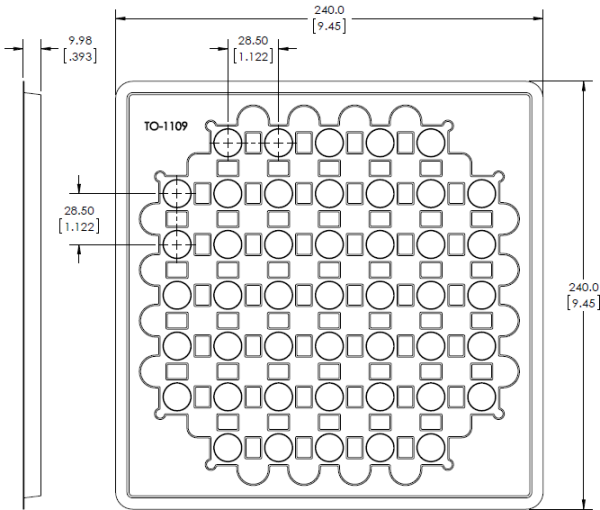

Each bag is boxed for easier storage/stacking

Trays are sealed in an anti-static bag

5 trays are stacked together with one tray as a cover

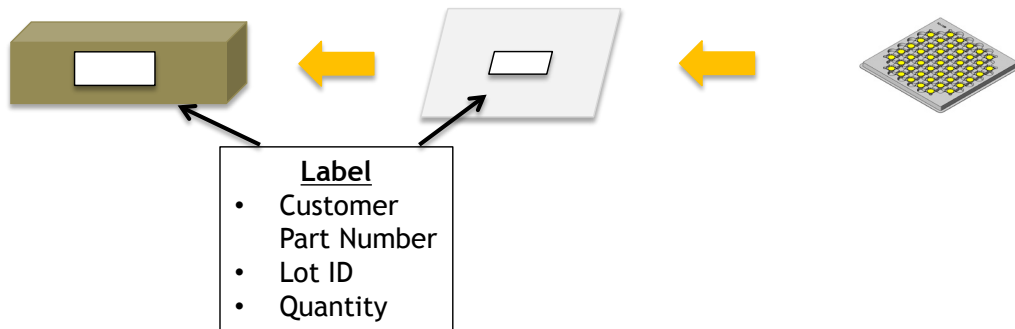

Handling Notes for XNova COBs

XNova products are designed for robust performance in general lighting application. However, care must be taken when handling and assembling the LEDs into their fixtures. To avoid damaging XNova COBs please follow these guide lines.

The following is an overview of the application notes detailing some of the practices to follow when working with these devices. More detailed information is available on the Luminus web site at www.luminus.com.

General Handling

Devices are made to be lifted or carried with tweezers on two adjacent corners opposite the contact pads. At no time should the devices be handled by or should anything come in contact with the light emitting surface (LES) area. This area includes the yellow colored circular area and the ring surrounding it. There are electrical connections under the LES which if damaged will cause the device to fail.

In addition, the ring frame itself should not be used for moving, lifting or carrying the device. Also do not attach any optics or mechanical holders to the ring as it is not capable to handle the mechanical stress.

Static Electricity

XNova COBs are electronic devices which can be damaged by electrostatic discharge (ESD). Please use appropriate measures to assure the devices do not experience ESD during their handling and or storage. ESD protection guidelines should be used at all times when working with XNova COBs.

Storage: XNova products are delivered in ESD shielded bags and should be stored in these bags until used.

Assembly: Individuals handling XNova COBs during assembly should be trained in ESD protection practices. Assemblers should maintain constant conductive contact with a path to ground by means of a wrist strap, ankle straps, mat or other ESD protection system.

Transporting: When transporting the devices from one assembly area to another, ESD shielded carts and carriers should be used.

Electrical Contact

XNova COBs are designed with contact pads on their top surface. These pads are clearly marked with + and – polarity. Wires can be soldered to the contact pads for electrical connections or other solderless connector products are available.

If wires are being soldered to the COB product, we recommend attaching these wires prior to mounting the devices to a heat sink. Please contact Luminus for specific recommendations on how to solder wires if not familiar with the standard practice. Luminus can also offer design recommendations for jigs to allow easily soldering multiple products in rapid succession.

Chemical Compatibility

The resin material used to form the LES can get hydrocarbons from the surrounding environment. As a result, certain chemical compounds are not recommended for use with the XNova products. Use of these compounds can cause damage to the light output of the device and may permanently damage the device. Please refer to www.luminus.com for a list of the compounds not recommended for use with the XNova COB products.

Thermal Interface Material (TIM)

Proper thermal management is critical for successful operation of any LED system. Excess operating temperature can reduce the light output of the device. And excessive heating can cause permanent damage to the device. Proper TIM material is a crucial component for effective heat transfer away from the LED during normal operation. Please refer to www.luminus.com for specific recommendations for TIM solutions.

XNova COB Specifications

Changes to specifications can happen without prior notice. The currently released data sheet will always be posted to the Luminus web site. Please refer to www.luminus.com for more information.

Mouser Electronics

Authorized Distributor

Click to View Pricing, Inventory, Delivery & Lifecycle Information:

Luminus Devices:

[CXM-14-27-80-36-AA00-F2-3](#) [CXM-14-30-95-36-AA00-F2-3](#) [CXM-14-30-80-36-AA00-F2-3](#) [CXM-14-27-95-36-AA00-F1-3](#) [CXM-14-27-80-36-AA00-F1-3](#) [CXM-14-30-95-36-AA00-F1-3](#) [CXM-14-30-80-36-AA00-F1-3](#) [CXM-14-35-80-36-AA00-F1-3](#) [CXM-14-50-80-36-AA00-F1-5](#) [CXM-14-30-90-36-AA00-F1-3](#) [CXM-14-27-90-36-AA00-F1-3](#) [CXM-14-40-80-36-AA00-F1-3](#) [CXM-14-30-80-36-AC02-F2-3](#) [CXM-14-30-90-36-AA00-F2-3](#) [CXM-14-40-80-36-AC00-F2-2](#) [CXM-14-27-90-36-AA00-F2-2](#) [CXM-14-40-90-36-AC00-F2-3](#) [CXM-14-35-80-36-AC00-F2-2](#) [CXM-14-30-90-36-AC00-F2-2](#) [CXM-14-30-90-36-AC02-F2-2](#) [CXM-14-50-80-36-AA00-F2-5](#) [CXM-14-30-95-36-AC02-F2-3](#) [CXM-14-40-80-36-AC00-F2-3](#) [CXM-14-27-90-36-AA00-F2-3](#) [CXM-14-30-95-36-AC02-F2-2](#) [CXM-14-27-95-36-AA00-F2-2](#) [CXM-14-35-80-36-AC00-F2-3](#) [CXM-14-50-80-36-AA00-F2-3](#) [CXM-14-30-80-36-AC02-F2-2](#) [CXM-14-40-80-36-AA00-F2-2](#) [CXM-14-40-90-36-AA00-F2-3](#) [CXM-14-35-80-36-AA00-F2-2](#) [CXM-14-40-90-36-AC00-F2-2](#) [CXM-14-30-80-36-AA00-F2-2](#) [CXM-14-40-65-80-36-AC00-F2-3](#) [CXM-14-30-90-36-AC02-F2-3](#) [CXM-14-50-80-36-AC00-F2-3](#) [CXM-14-50-80-36-AC00-F2-5](#) [CXM-14-30-95-36-AC00-F2-2](#) [CXM-14-30-80-36-AC00-F2-3](#) [CXM-14-35-90-36-AC00-F2-3](#) [CXM-14-30-95-36-AC00-F2-3](#) [CXM-14-65-80-36-AC00-F2-5](#) [CXM-14-40-80-36-AA00-F2-3](#) [CXM-14-30-90-36-AA00-F2-2](#) [CXM-14-30-95-36-AA00-F2-2](#) [CXM-14-30-80-36-AC00-F2-2](#) [CXM-14-35-80-36-AA00-F2-3](#) [CXM-14-35-90-36-AC00-F2-2](#) [CXM-14-30-90-36-AC00-F2-3](#) [CXM-14-27-95-36-AA00-F2-3](#) [CXM-14-40-90-36-AA00-F2-2](#) [CXM-14-27-80-36-AA00-F2-2](#) [CXM-14-27-80-36-AC00-F2-3](#) [CXM-14-27-95-36-AC00-F2-3](#) [CXM-14-27-90-36-AC00-F2-3](#) [CXM-14-27-80-36-AC00-F2-2](#) [CXM-14-27-95-36-AC00-F2-2](#) [CXM-14-40-95-36-AA00-F2-2](#) [CXM-14-40-95-36-AA00-F2-3](#) [CXM-14-65-80-36-AA00-F2-3](#) [CXM-14-65-80-36-AA00-F2-5](#) [CXM-14-35-90-36-AA00-F2-3](#) [CXM-14-35-90-36-AA00-F2-2](#) [CXM-14-27-90-36-AC00-F2-2](#) [CXM-14-40-95-36-AC00-F2-3](#) [CXM-14-40-95-36-AC00-F2-2](#) [CXM-14-30-80-36-AA02-F2-2](#) [CXM-14-30-80-36-AA02-F2-3](#) [CXM-14-35-95-36-AA00-F2-3](#) [CXM-14-50-70-36-AC00-F2-3](#) [CXM-14-35-95-36-AA00-F2-2](#) [CXM-14-40-70-36-AC00-F2-2](#) [CXM-14-50-70-36-AC00-F2-5](#) [CXM-14-40-70-36-AC00-F2-3](#) [CXM-14-65-70-36-AC00-F2-5](#) [CXM-14-65-70-36-AC00-F2-3](#) [CXM-14-30-90-36-AA02-F2-3](#) [CXM-14-30-90-36-AA02-F2-2](#)