

NCP706

1 A, 1% Precision Very Low Dropout Voltage Regulator with Enable

The NCP706 is a Very Low Dropout Regulator which provides up to 1 A of load current and maintains excellent output voltage accuracy of 1% including line, load and temperature variations. The operating input voltage range from 2.4 V up to 5.5 V makes this device suitable for Li-ion battery powered products as well as post-regulation applications. The product is available in 2.1 V, 2.2 V, 2.95 V, 3.0 V and 3.3 V fixed output voltage options. NCP706 is fully protected against overheating and output short circuit.

Very small 8-pin XDFN8 1.6 x 1.2, 04P package makes the device especially suitable for space constrained portable applications such as tablets and smartphones.

Features

- Operating Input Voltage Range: 2.4 V to 5.5 V
- Fixed Output Voltage Options: 2.1 V, 2.2 V, 2.95 V, 3.0 V and 3.3 V
Other Output Voltage Options Available on Request.
- Low Quiescent Current of Typ. 200 μ A
- Very Low Dropout: 155 mV Max. at $I_{OUT} = 1$ A
- $\pm 1\%$ Accuracy Over Load/Line/Temperature
- High PSRR: 60 dB at 1 kHz
- Internal Soft-Start to Limit the Inrush Current
- Thermal Shutdown and Current Limit Protections
- Stable with a 4.7 μ F Ceramic Output Capacitor
- Available in XDFN8 1.6 x 1.2, 04P 8-pin Package
- These are Pb-Free Devices

Typical Applications

- Tablets, Smartphones,
- Wireless Handsets, Portable Media Players
- Portable Medical Equipment
- Other Battery Powered Applications

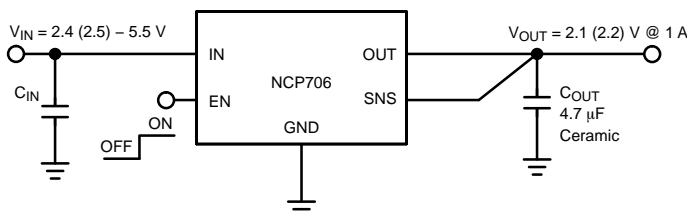

Figure 1. Typical Application Schematic



ON Semiconductor®

www.onsemi.com



XDFN8
CASE 711AS

MARKING DIAGRAM

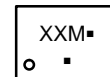

XX = Specific Device Code
M = Date Code
▪ = Pb-Free Package

(Note: Microdot may be in either location)

PIN CONNECTION

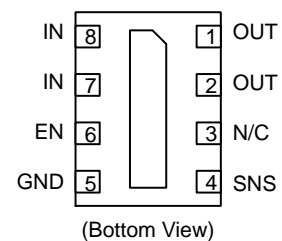
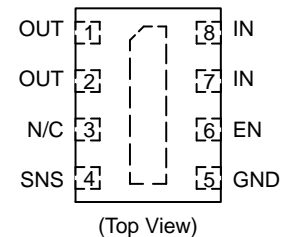

ORDERING INFORMATION

See detailed ordering, marking and shipping information on page 15 of this data sheet.

NCP706

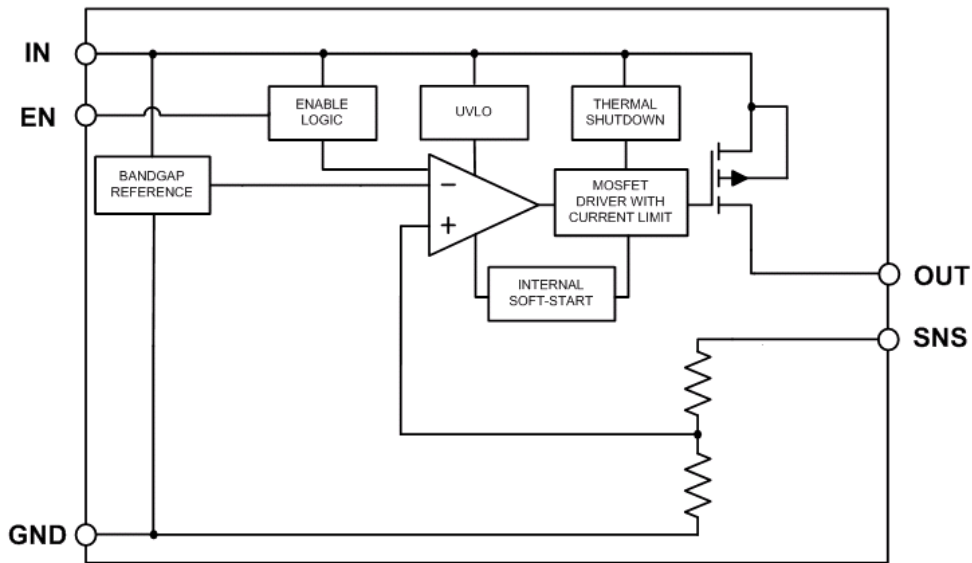

Figure 2. Simplified Internal Schematic Block Diagram

PIN FUNCTION DESCRIPTION

Pin No. XDFN8	Pin Name	Description
1	OUT	Regulated output voltage. A minimum 4.7 μ F ceramic capacitor is needed from this pin to ground to assure stability.
2	OUT	
3	N/C	Not connected. This pin can be tied to ground to improve thermal dissipation.
4	SNS	Remote sense connection. This pin should be connected to the output voltage rail.
5	GND	Power supply ground.
6	EN	Enable pin. Driving EN over 0.9 V turns on the regulator. Driving EN below 0.4 V puts the regulator into shutdown mode.
7	IN	Input pin. A small capacitor is needed from this pin to ground to assure stability.
8	IN	
-	Exposed Pad	This pad enhances thermal performance and is electrically connected to GND. It is recommended that the exposed pad is connected to the ground plane on the board or otherwise left open.

NCP706

ABSOLUTE MAXIMUM RATINGS

Rating	Symbol	Value	Unit
Input Voltage (Note 1)	V_{IN}	-0.3 V to 6 V	V
Output Voltage	V_{OUT}	-0.3 V to $V_{IN} + 0.3$ V	V
Enable Input	V_{EN}	-0.3 V to $V_{IN} + 0.3$ V	V
Output Short Circuit Duration	t_{SC}	Indefinite	s
Maximum Junction Temperature	$T_{J(MAX)}$	150	°C
Storage Temperature	T_{STG}	-55 to 150	°C
ESD Capability, Human Body Model (Note 2)	ESD_{HBM}	2000	V
ESD Capability, Machine Model (Note 2)	ESD_{MM}	200	V

Stresses exceeding those listed in the Maximum Ratings table may damage the device. If any of these limits are exceeded, device functionality should not be assumed, damage may occur and reliability may be affected.

1. Refer to ELECTRICAL CHARACTERISTICS and APPLICATION INFORMATION for Safe Operating Area.
2. This device series incorporates ESD protection and is tested by the following methods:
 - ESD Human Body Model tested per EIA/JESD22-A114
 - Latch-up Current Maximum Rating tested per JEDEC standard: JESD78

THERMAL CHARACTERISTICS

Rating	Symbol	Value	Unit
Thermal Characteristics, XDFN8 1.6x1.2, 04P Thermal Resistance, Junction-to-Air	$R_{\theta JA}$	160	°C/W

NCP706

ELECTRICAL CHARACTERISTICS – VOLTAGE VERSION 2.1 V

–40°C ≤ T_J ≤ 125°C; V_{IN} = V_{OUT(NOM)} + 0.3 V or 2.4 V, whichever is greater; I_{OUT} = 10 mA, C_{IN} = C_{OUT} = 4.7 μF, V_{EN} = 0.9 V, unless otherwise noted. Typical values are at T_J = +25°C. (Note 3)

Parameter	Test Conditions	Symbol	Min	Typ	Max	Unit
Operating Input Voltage		V _{IN}	2.4		5.5	V
Undervoltage lock-out	V _{IN} rising	UVLO	1.2	1.6	1.9	V
Output Voltage Accuracy	V _{OUT} + 0.3 V ≤ V _{IN} ≤ 4.5 V, I _{OUT} = 0 – 1 A	V _{OUT}	2.079	2.10	2.121	V
Line Regulation	V _{OUT} + 0.3 V ≤ V _{IN} ≤ 4.5 V, I _{OUT} = 10 mA	Reg _{LINE}		2		mV
Load Regulation	I _{OUT} = 0 mA to 1 A	Reg _{LOAD}		2		mV
Load Transient	I _{OUT} = 10 mA to 1 A or 10 mA to 1 A in 10 μs, C _{OUT} = 10 μF	Tran _{LOAD}		±120		mV
Dropout voltage (Note 4)	I _{OUT} = 1 A, V _{OUT(nom)} = 2.1 V	V _{DO}			300	mV
Output Current Limit	V _{OUT} = 90% V _{OUT(nom)}	I _{CL}	1.1			A
Quiescent current	I _{OUT} = 0 mA	I _Q		180	230	μA
Ground current	I _{OUT} = 1 A	I _{GND}		200		μA
Shutdown current	V _{EN} ≤ 0 V, V _{IN} = 2.0 to 5.5 V			0.1	1	μA
Reverse Leakage Current in Shutdown	V _{IN} = 5.5 V, V _{OUT} = V _{OUT(NOM)} , V _{EN} < 0.4 V	I _{REV}		1.5	5	μA
EN Pin High Threshold	V _{EN} Voltage increasing	V _{EN_HI}	0.9			V
EN Pin Low Threshold	V _{EN} Voltage decreasing	V _{EN_LO}			0.4	V
EN Pin Input Current	V _{EN} = 5.5 V	I _{EN}		100	500	nA
Turn-on Time	C _{OUT} = 4.7 μF, from assertion EN pin to 98% V _{out(nom)}	t _{ON}		200		μs
Power Supply Rejection Ratio	V _{IN} = 2.6 V, V _{OUT} = 2.1 V, I _{OUT} = 0.5 A	PSRR	f = 100 Hz f = 1 kHz f = 10 kHz	60 60 40		dB
Output Noise Voltage	V _{OUT} = 2.1 V, V _{IN} = 2.6 V, I _{OUT} = 0.5 A, f = 100 Hz to 100 kHz	V _{NOISE}		280		μV _{rms}
Thermal Shutdown Temperature	Temperature increasing from T _J = +25°C	T _{SD}		160		°C
Thermal Shutdown Hysteresis	Temperature falling from T _{SD}	T _{SDH}	–	20	–	°C

3. Performance guaranteed over the indicated operating temperature range by design and/or characterization production tested at T_J = T_A = 25°C. Low duty cycle pulse techniques are used during testing to maintain the junction temperature as close to ambient as possible.
4. Characterized when V_{OUT} falls 100 mV below the regulated voltage at V_{IN} = V_{OUT(NOM)} + 0.3 V.

NCP706

ELECTRICAL CHARACTERISTICS – VOLTAGE VERSION 2.2 V

–40°C ≤ T_J ≤ 125°C; V_{IN} = V_{OUT(NOM)} + 0.3 V or 2.5 V, whichever is greater; I_{OUT} = 10 mA, C_{IN} = C_{OUT} = 4.7 μF, V_{EN} = 0.9 V, unless otherwise noted. Typical values are at T_J = +25°C. (Note 5)

Parameter	Test Conditions	Symbol	Min	Typ	Max	Unit
Operating Input Voltage		V _{IN}	2.5		5.5	V
Undervoltage lock-out	V _{IN} rising	UVLO	1.2	1.6	1.9	V
Output Voltage Accuracy	V _{OUT} + 0.3 V ≤ V _{IN} ≤ 4.5 V, I _{OUT} = 0 – 1 A	V _{OUT}	2.178	2.2	2.222	V
Line Regulation	V _{OUT} + 0.3 V ≤ V _{IN} ≤ 4.5 V, I _{OUT} = 10 mA	Reg _{LINE}		2		mV
Load Regulation	I _{OUT} = 0 mA to 1 A	Reg _{LOAD}		2		mV
Load Transient	I _{OUT} = 10 mA to 1 A or 10 mA to 1 A in 10 μs, C _{OUT} = 10 μF	Tran _{LOAD}		±120		mV
Dropout voltage (Note 6)	I _{OUT} = 1 A, V _{OUT(nom)} = 2.2 V	V _{DO}			300	mV
Output Current Limit	V _{OUT} = 90% V _{OUT(nom)}	I _{CL}	1.1			A
Quiescent current	I _{OUT} = 0 mA	I _Q		180	230	μA
Ground current	I _{OUT} = 1 A	I _{IGND}		200		μA
Shutdown current	V _{EN} ≤ 0 V, V _{IN} = 2.0 to 5.5 V			0.1	1	μA
EN Pin High Threshold EN Pin Low Threshold	V _{EN} Voltage increasing V _{EN} Voltage decreasing	V _{EN_HI} V _{EN_LO}	0.9		0.4	V
EN Pin Input Current	V _{EN} = 5.5 V	I _{EN}		100	500	nA
Turn-on Time	C _{OUT} = 4.7 μF, from assertion EN pin to 98% V _{out(nom)}	t _{ON}		200		μs
Power Supply Rejection Ratio	V _{IN} = 3.2 V, V _{OUT} = 2.2 V I _{OUT} = 0.5 A	PSRR		f = 100 Hz		dB
	f = 1 kHz					
	f = 10 kHz					
Output Noise Voltage	V _{OUT} = 2.2 V, V _{IN} = 2.7 V, I _{OUT} = 0.5 A f = 100 Hz to 100 kHz	V _{NOISE}		300		μV _{rms}
Thermal Shutdown Temperature	Temperature increasing from T _J = +25°C	T _{SD}		160		°C
Thermal Shutdown Hysteresis	Temperature falling from T _{SD}	T _{SDH}	–	20	–	°C

5. Performance guaranteed over the indicated operating temperature range by design and/or characterization production tested at T_J = T_A = 25°C. Low duty cycle pulse techniques are used during testing to maintain the junction temperature as close to ambient as possible.
6. Characterized when V_{OUT} falls 100 mV below the regulated voltage at V_{IN} = V_{OUT(NOM)} + 0.3 V.

NCP706

ELECTRICAL CHARACTERISTICS – VOLTAGE VERSION 2.95 V

–40°C ≤ T_J ≤ 125°C; V_{IN} = V_{OUT(NOM)} + 0.3 V or 3.3 V, whichever is greater; I_{OUT} = 10 mA, C_{IN} = C_{OUT} = 4.7 μF, V_{EN} = 0.9 V, unless otherwise noted. Typical values are at T_J = +25°C. (Note 7)

Parameter	Test Conditions	Symbol	Min	Typ	Max	Unit
Operating Input Voltage		V _{IN}	2.4		5.5	V
Undervoltage lock-out	V _{IN} rising, I _{OUT} = 0	UVLO	1.2	1.6	1.9	V
Output Voltage Accuracy	V _{OUT} + 0.3 V ≤ V _{IN} ≤ 4.5 V, I _{OUT} = 0 – 1 A	V _{OUT}	2.9205	2.95	2.9795	V
Line Regulation	V _{OUT} + 0.3 V ≤ V _{IN} ≤ 4.5 V, I _{OUT} = 10 mA	Reg _{LINE}		2		mV
Load Regulation	I _{OUT} = 0 mA to 1 A, V _{IN} = 3.3 V	Reg _{LOAD}		2		mV
Load Transient	I _{OUT} = 10 mA to 1 A in 10 μs, V _{IN} = 3.5 V C _{OUT} = 10 μF	Tran _{LOAD}		±120		mV
Dropout voltage (Note 8)	I _{OUT} = 1 A, V _{OUT(nom)} = 3.0 V	V _{DO}		155	230	mV
Output Current Limit	V _{OUT} = 90% V _{OUT(nom)}	I _{CL}	1.1			A
Quiescent current	I _{OUT} = 0 mA	I _Q		170	230	μA
Ground current	I _{OUT} = 1 A	I _{GND}		200		μA
Shutdown current	V _{EN} ≤ 0 V, V _{IN} = 2.4 to 5.5 V			0.1	1	μA
EN Pin High Threshold EN Pin Low Threshold	V _{EN} Voltage increasing V _{EN} Voltage decreasing	V _{EN_HI} V _{EN_LO}	0.9		0.4	V
EN Pin Input Current	V _{EN} = 5.5 V	I _{EN}		100	500	nA
Turn-on Time	C _{OUT} = 4.7 μF, from assertion EN pin to 98% V _{out(nom)}	t _{ON}		150		μs
Power Supply Rejection Ratio	V _{IN} = 3.5 V + 200 mVpp modulation, V _{OUT} = 2.95 V I _{OUT} = 0.5 A, C _{OUT} = 4.7 μF	PSRR		65 58 52		dB
Output Noise Voltage	V _{OUT} = 2.95 V, V _{IN} = 4.0 V, I _{OUT} = 0.5 A f = 100 Hz to 100 kHz	V _{NOISE}		300		μV _{rms}
Thermal Shutdown Temperature	Temperature increasing from T _J = +25°C	T _{SD}		160		°C
Thermal Shutdown Hysteresis	Temperature falling from T _{SD}	T _{SDH}	–	20	–	°C

7. Performance guaranteed over the indicated operating temperature range by design and/or characterization production tested at T_J = T_A = 25°C. Low duty cycle pulse techniques are used during testing to maintain the junction temperature as close to ambient as possible.

8. Characterized when V_{OUT} falls 90 mV below the regulated voltage at V_{IN} = 3.3 V, I_{OUT} = 10 mA.

NCP706

ELECTRICAL CHARACTERISTICS – VOLTAGE VERSION 3.0 V

–40°C ≤ T_J ≤ 125°C; V_{IN} = V_{OUT(NOM)} + 0.3 V or 3.3 V, whichever is greater; I_{OUT} = 10 mA, C_{IN} = C_{OUT} = 4.7 μF, V_{EN} = 0.9 V, unless otherwise noted. Typical values are at T_J = +25°C. (Note 9)

Parameter	Test Conditions	Symbol	Min	Typ	Max	Unit
Operating Input Voltage		V _{IN}	2.4		5.5	V
Undervoltage lock-out	V _{IN} rising, I _{OUT} = 0	UVLO	1.2	1.6	1.9	V
Output Voltage Accuracy	V _{OUT} + 0.3 V ≤ V _{IN} ≤ 4.5 V, I _{OUT} = 0 – 1 A	V _{OUT}	2.97	3.0	3.03	V
Line Regulation	V _{OUT} + 0.3 V ≤ V _{IN} ≤ 4.5 V, I _{OUT} = 10 mA	Reg _{LINE}		2		mV
Load Regulation	I _{OUT} = 0 mA to 1 A, V _{IN} = 3.3 V	Reg _{LOAD}		2		mV
Load Transient	I _{OUT} = 10 mA to 1 A in 10 μs, V _{IN} = 3.5 V C _{OUT} = 10 μF	Tran _{LOAD}		±120		mV
Dropout voltage (Note 10)	I _{OUT} = 1 A, V _{OUT(nom)} = 3.0 V	V _{DO}		155	230	mV
Output Current Limit	V _{OUT} = 90% V _{OUT(nom)}	I _{CL}	1.1			A
Quiescent current	I _{OUT} = 0 mA	I _Q		170	230	μA
Ground current	I _{OUT} = 1 A	I _{GND}		200		μA
Shutdown current	V _{EN} ≤ 0 V, V _{IN} = 2.0 to 5.5 V			0.1	1	μA
EN Pin High Threshold EN Pin Low Threshold	V _{EN} Voltage increasing V _{EN} Voltage decreasing	V _{EN_HI} V _{EN_LO}	0.9		0.4	V
EN Pin Input Current	V _{EN} = 5.5 V	I _{EN}		100	500	nA
Turn-on Time	C _{OUT} = 4.7 μF, from assertion EN pin to 98% V _{out(nom)}	t _{ON}		150		μs
Power Supply Rejection Ratio	V _{IN} = 3.5 V + 200 mVpp modulation, V _{OUT} = 3.0 V I _{OUT} = 0.5 A, C _{OUT} = 4.7 μF	PSRR		65 58 52		dB
Output Noise Voltage	V _{OUT} = 3.0 V, V _{IN} = 4.0 V, I _{OUT} = 0.5 A f = 100 Hz to 100 kHz	V _{NOISE}		300		μV _{rms}
Thermal Shutdown Temperature	Temperature increasing from T _J = +25°C	T _{SD}		160		°C
Thermal Shutdown Hysteresis	Temperature falling from T _{SD}	T _{SDH}	–	20	–	°C

9. Performance guaranteed over the indicated operating temperature range by design and/or characterization production tested at T_J = T_A = 25°C. Low duty cycle pulse techniques are used during testing to maintain the junction temperature as close to ambient as possible.

10. Characterized when V_{OUT} falls 90 mV below the regulated voltage at V_{IN} = 3.3 V, I_{OUT} = 10 mA.

Product parametric performance is indicated in the Electrical Characteristics for the listed test conditions, unless otherwise noted. Product performance may not be indicated by the Electrical Characteristics if operated under different conditions.

TYPICAL CHARACTERISTICS

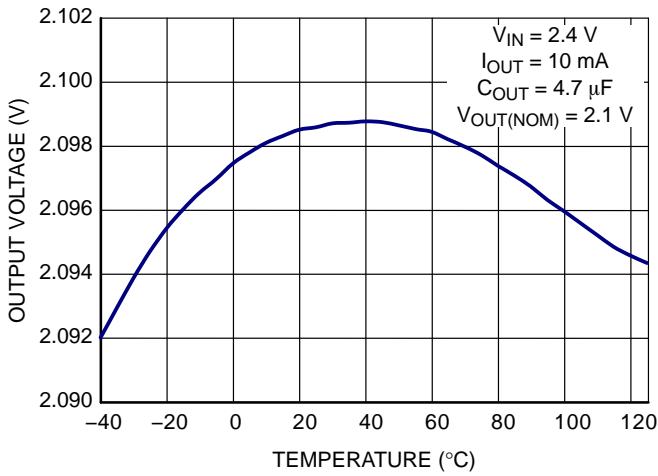

Figure 3. Output Voltage vs. Temperature

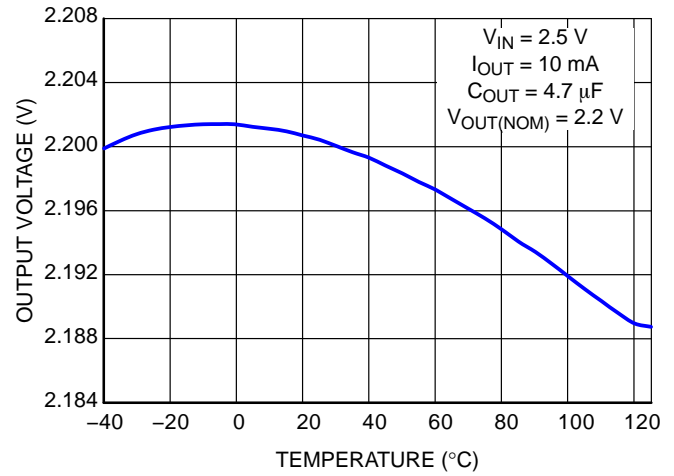

Figure 4. Output Voltage vs. Temperature

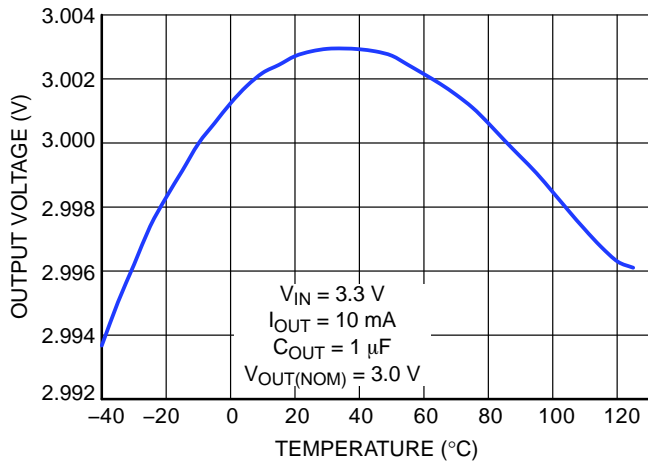

Figure 5. Output Voltage vs. Temperature

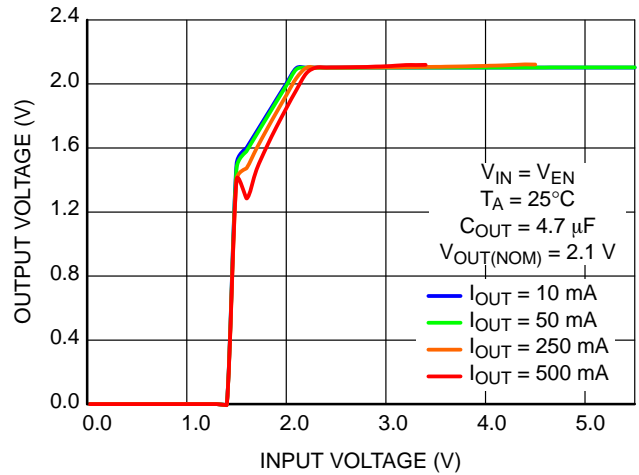

Figure 6. Output Voltage vs. Input Voltage

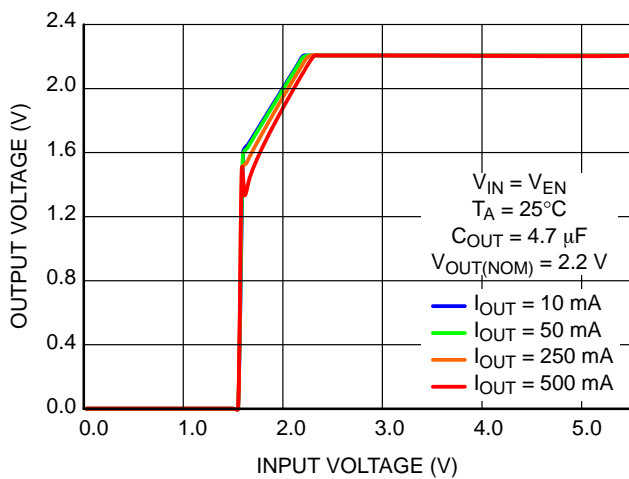

Figure 7. Output Voltage vs. Input Voltage

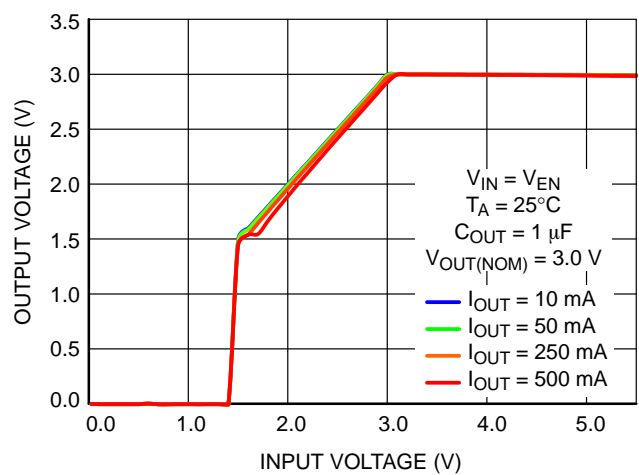

Figure 8. Output Voltage vs. Input Voltage

TYPICAL CHARACTERISTICS

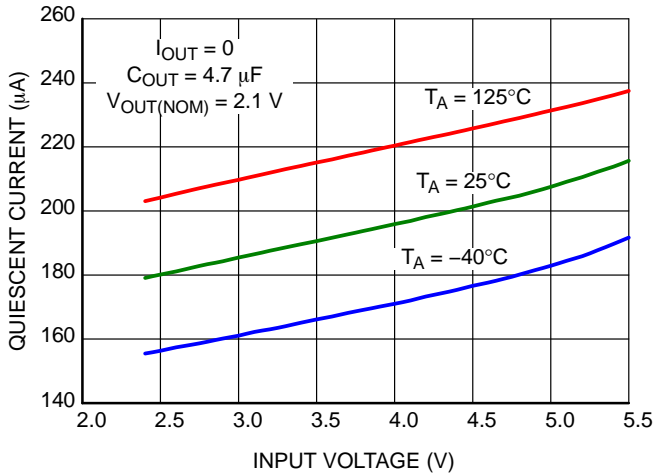

Figure 9. Quiescent Current vs. Input Voltage

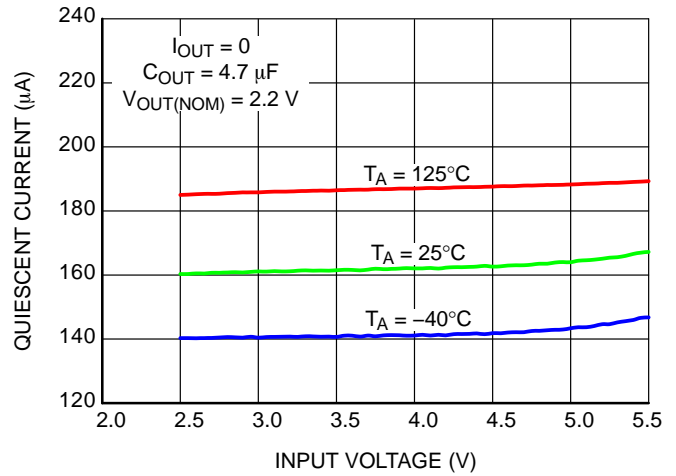

Figure 10. Quiescent Current vs. Input Voltage

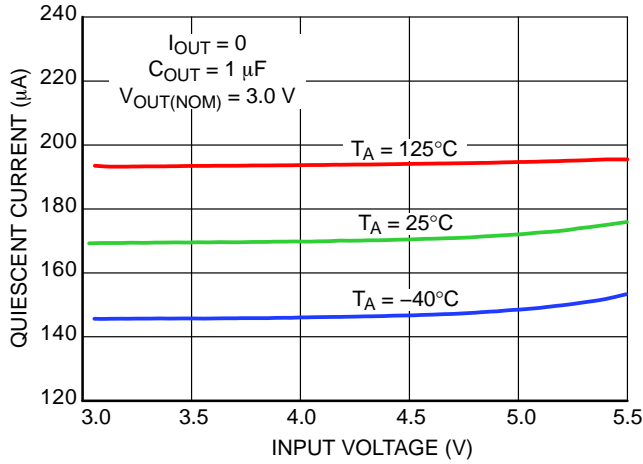

Figure 11. Quiescent Current vs. Input Voltage

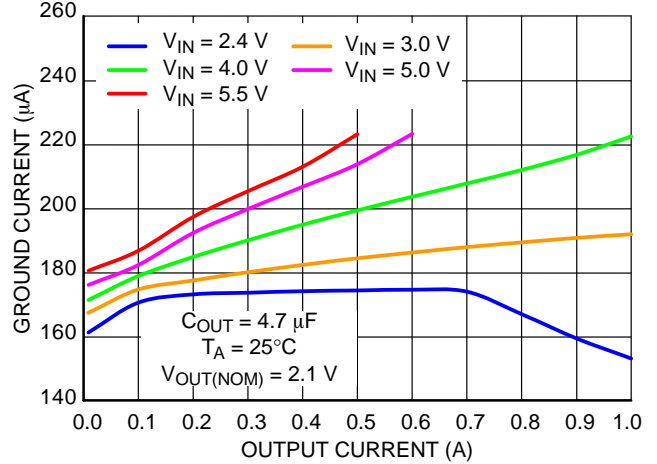

Figure 12. Ground Current vs. Output Current

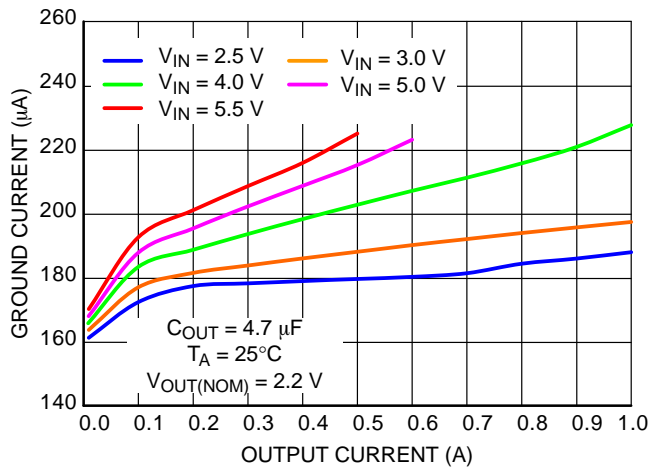

Figure 13. Ground Current vs. Output Current

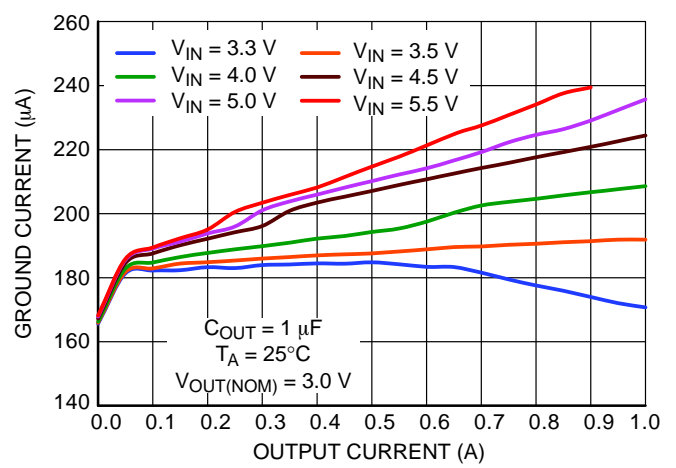

Figure 14. Ground Current vs. Output Current

TYPICAL CHARACTERISTICS

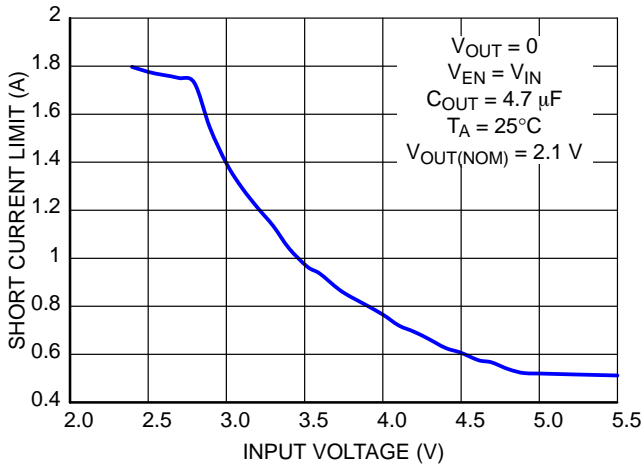

Figure 15. Short Current Limitation vs. Input Voltage

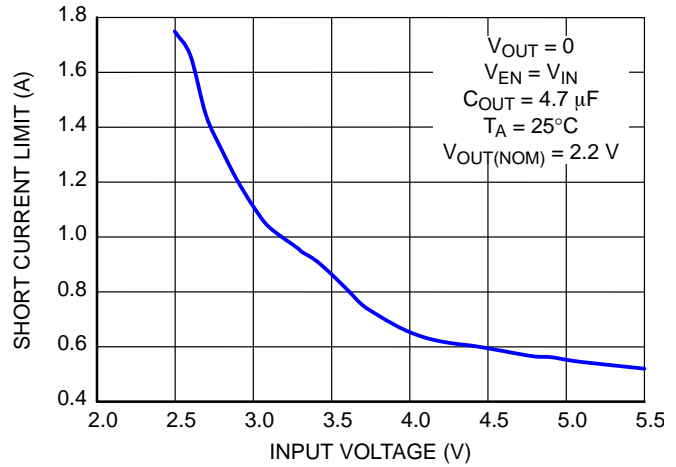

Figure 16. Short Current Limitation vs. Input Voltage

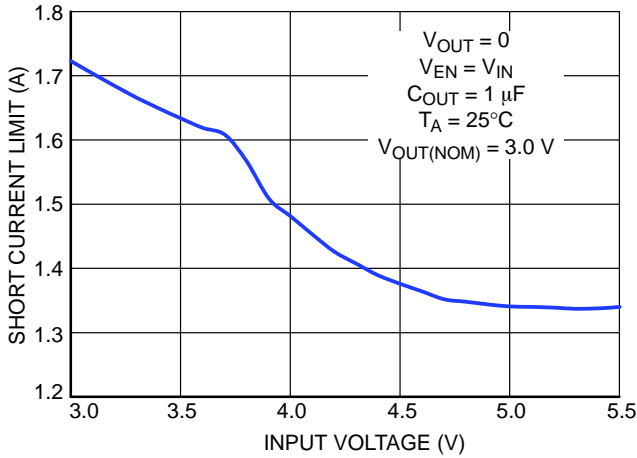

Figure 17. Short Current Limitation vs. Input Voltage

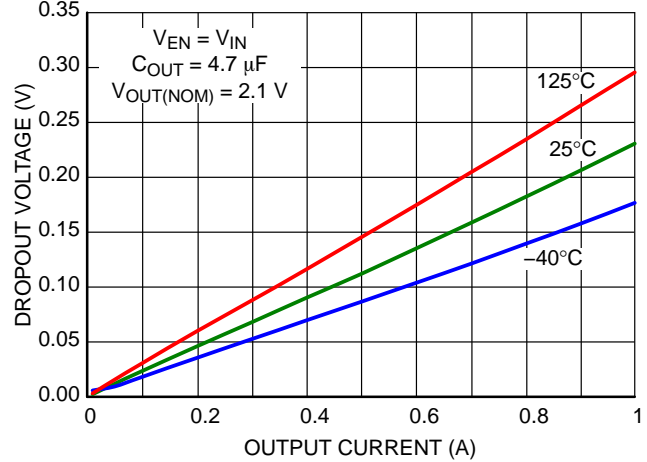

Figure 18. Dropout Voltage vs. Output Current

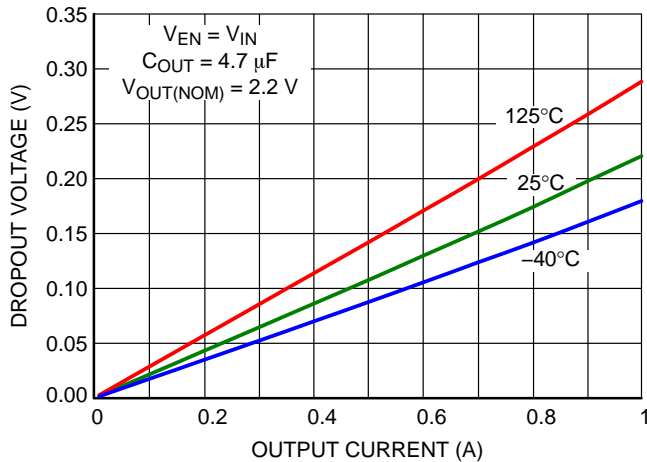

Figure 19. Dropout Voltage vs. Output Current

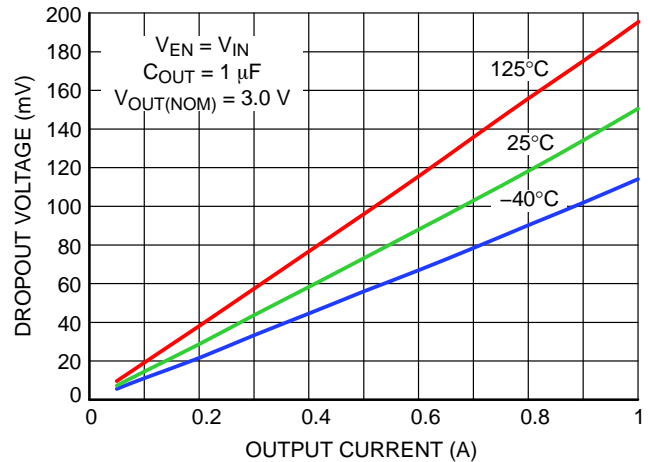

Figure 20. Dropout Voltage vs. Output Current

TYPICAL CHARACTERISTICS

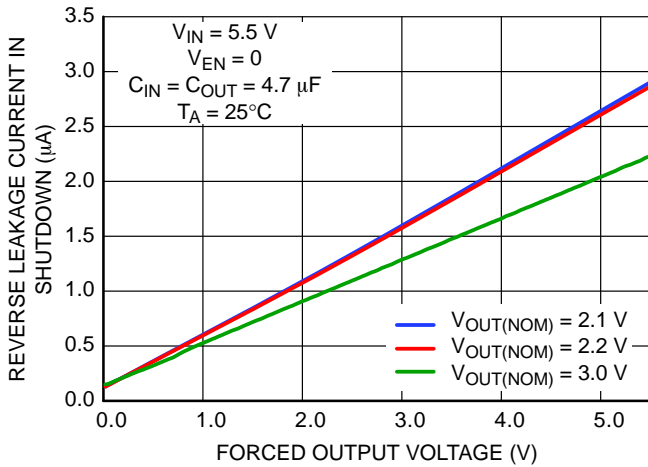

Figure 21. Reverse Leakage Current in Shutdown

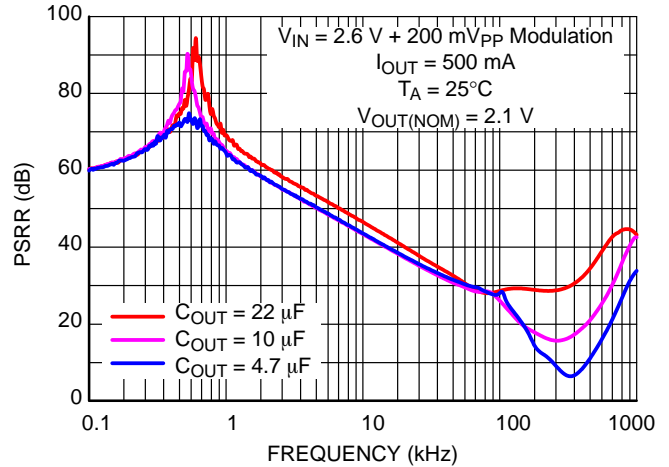

Figure 22. PSRR vs. Frequency & Output Capacitor

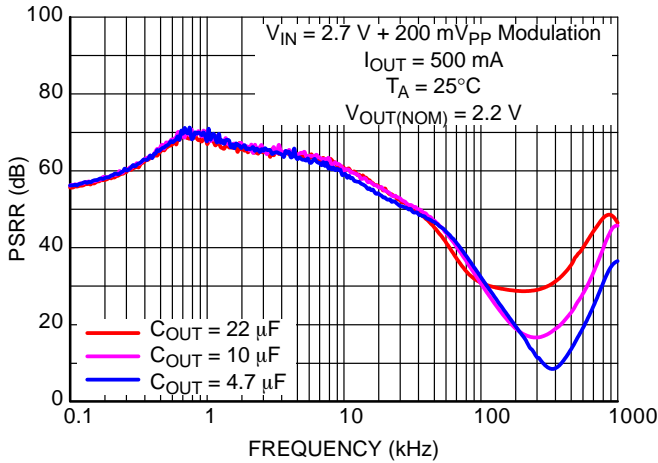

Figure 23. PSRR vs. Frequency & Output Capacitor

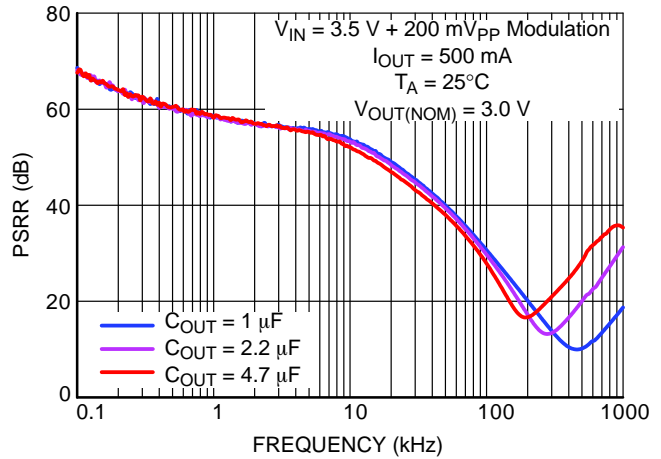

Figure 24. PSRR vs. Frequency & Output Capacitor

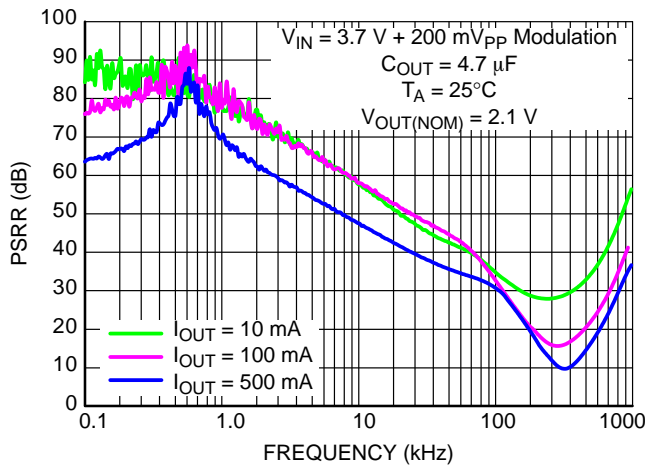

Figure 25. PSRR vs. Frequency & Output Current

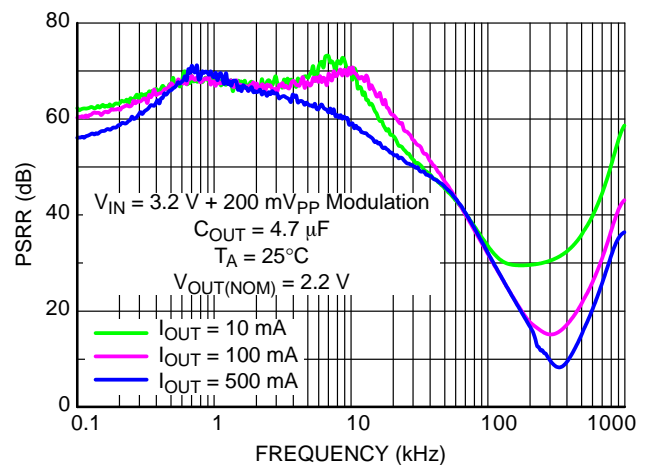

Figure 26. PSRR vs. Frequency & Output Current

TYPICAL CHARACTERISTICS

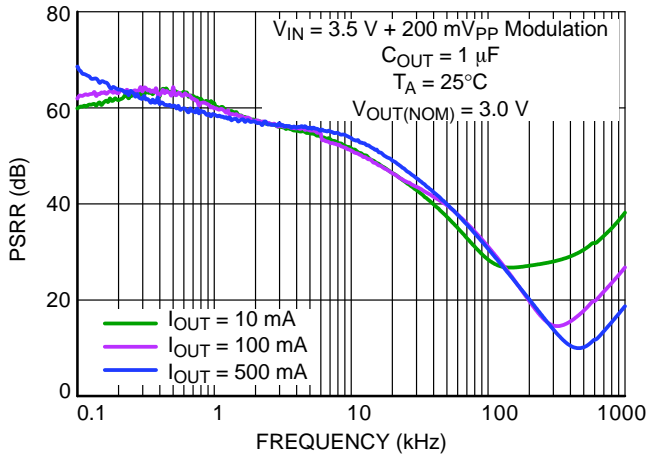

Figure 27. PSRR vs. Frequency & Output Current

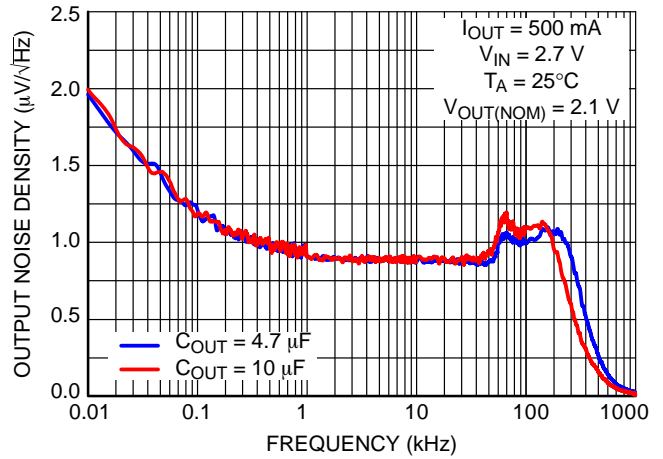

Figure 28. Output Noise Density vs. Frequency

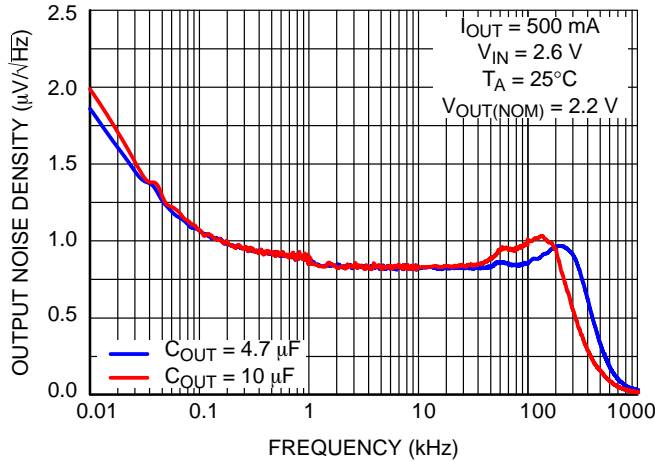

Figure 29. Output Noise Density vs. Frequency

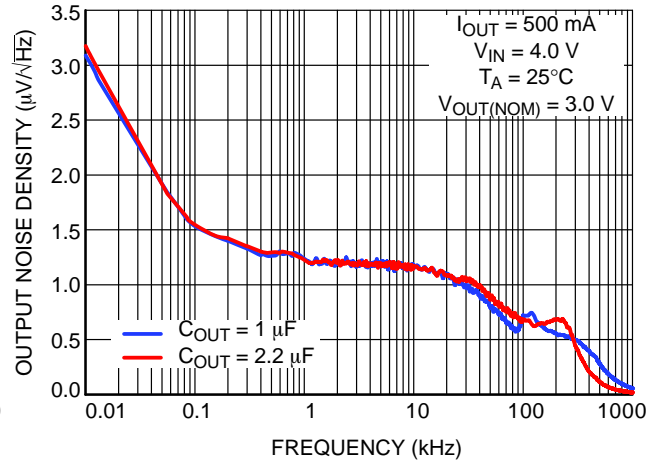

Figure 30. Output Noise Density vs. Frequency

NCP706

TYPICAL CHARACTERISTICS

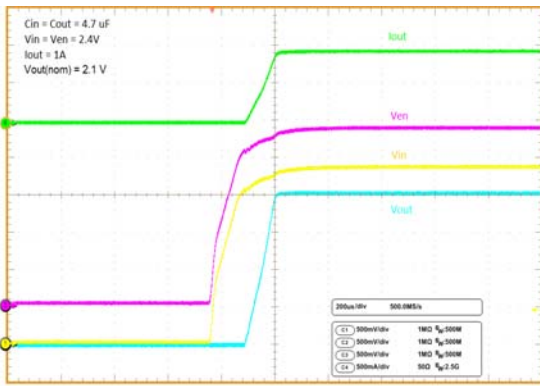

Figure 31. Turn-on by Coupled Input and Enable Pins

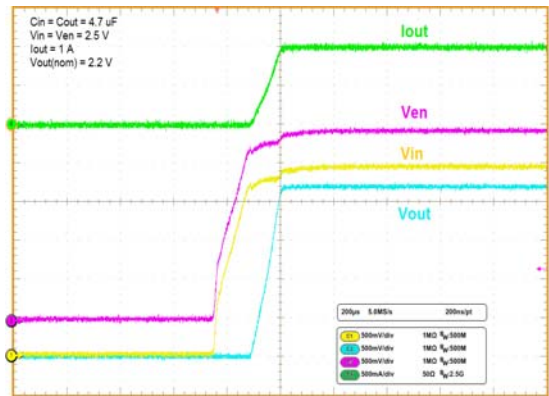

Figure 32. Turn-on by Coupled Input and Enable Pins

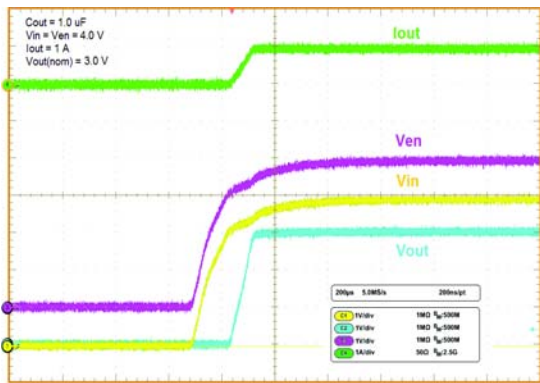

Figure 33. Turn-on by Coupled Input and Enable Pins

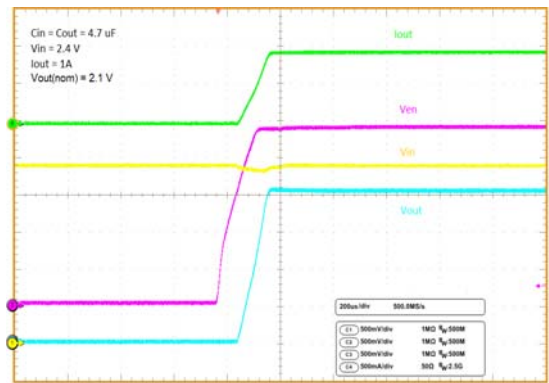

Figure 34. Turn-on by Enable Signal

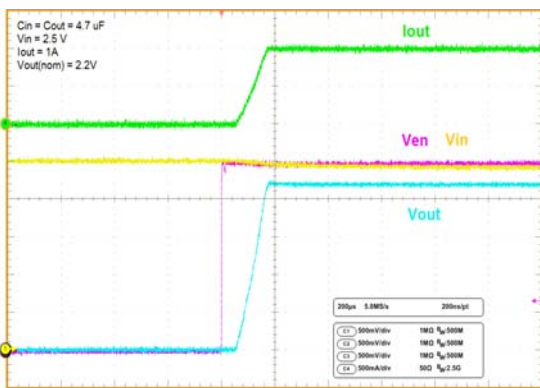

Figure 35. Turn-on by Enable Signal

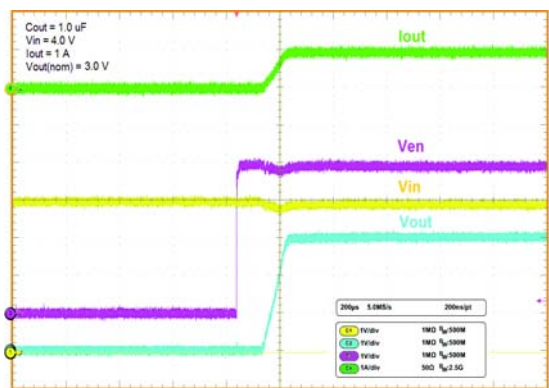

Figure 36. Turn-on by Enable Signal

NCP706

TYPICAL CHARACTERISTICS

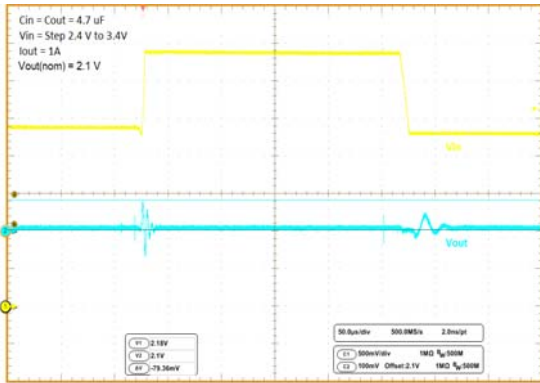

Figure 37. Line Transient Response

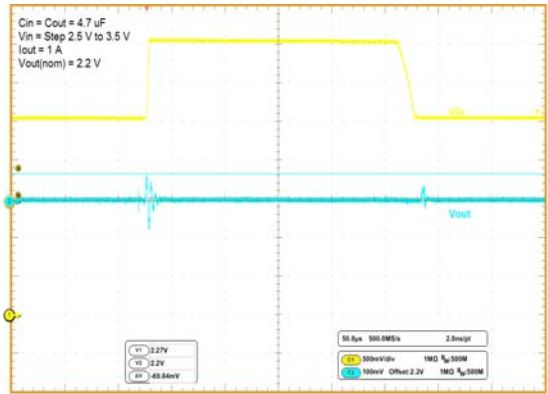

Figure 38. Line Transient Response

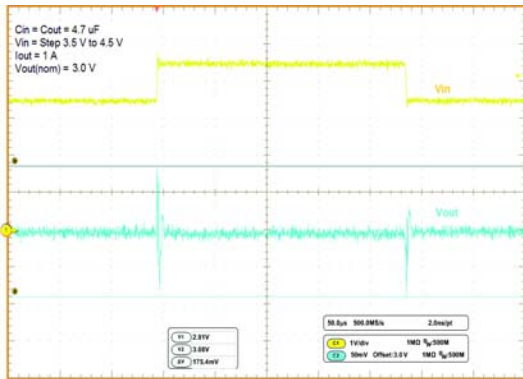

Figure 39. Line Transient Response

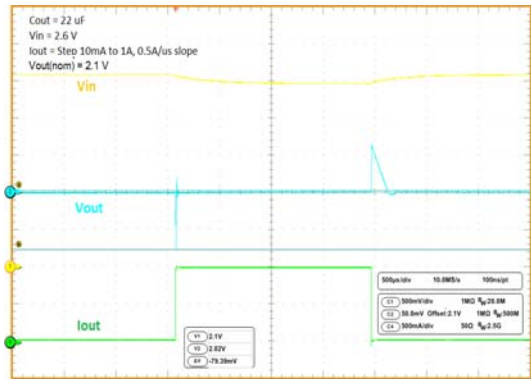

Figure 40. Load Transient Response

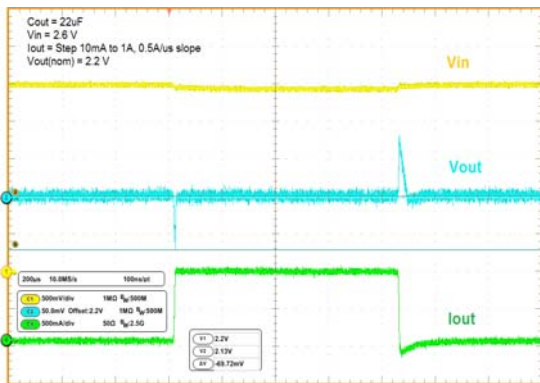

Figure 41. Load Transient Response

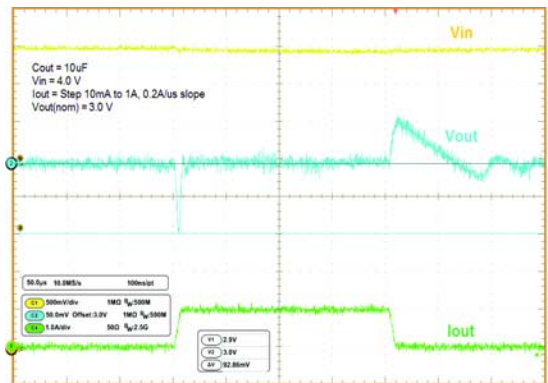

Figure 42. Load Transient Response

NCP706

APPLICATIONS INFORMATION

Input Decoupling (C_{in})

A 4.7 µF capacitor either ceramic or tantalum is recommended and should be connected as close as possible to the pins of NCP706 device. Higher values and lower ESR will improve the overall line transient response.

Output Decoupling (C_{out})

The minimum decoupling value for NCP706MX21TAG and NCP706MX22TAG devices is 4.7 µF and can be augmented to fulfill stringent load transient requirements. The minimum decoupling value for NCP706MX295TAG and NCP706MX706300TAG devices is 1 µF. The regulator accepts ceramic chip capacitors MLCC. If a tantalum capacitor is used, and its ESR is large, the loop oscillation may result. Larger values improve noise rejection and PSRR.

Enable Operation

The enable pin EN will turn on or off the regulator. These limits of threshold are covered in the electrical specification section of this data sheet. If the enable is not used then the pin should be connected to V_{IN}.

Hints

Please be sure the V_{in} and GND lines are sufficiently wide. If their impedance is high, noise pickup or unstable operation may result.

Set external components, especially the output capacitor, as close as possible to the circuit.

The sense pin SNS trace is recommended to be kept as far from noisy power traces as possible and as close to load as possible.

Thermal

As power across the NCP706 increases, it might become necessary to provide some thermal relief. The maximum power dissipation supported by the device is dependent upon board design and layout. Mounting pad configuration on the PCB, the board material, and also the ambient temperature affect the rate of temperature rise for the part. This is stating that when the NCP706 has good thermal conductivity through the PCB, the junction temperature will be relatively low with high power dissipation.

The power dissipation across the device can be roughly represented by the equation:

$$P_D = (V_{IN} - V_{OUT}) * I_{OUT} \text{ [W]} \quad (\text{eq. 1})$$

The maximum power dissipation depends on the thermal resistance of the case and circuit board, the temperature differential between the junction and ambient, PCB orientation and the rate of air flow.

The maximum allowable power dissipation can be calculated using the following equation:

$$P_{MAX} = (T_J - T_A) / \theta_{JA} \text{ [W]} \quad (\text{eq. 2})$$

Where (T_J - T_A) is the temperature differential between the junction and the surrounding environment and θ_{JA} is the thermal resistance from the junction to the ambient.

Connecting the exposed pad and non connected pin 3 to a large ground pad or plane helps to conduct away heat and improves thermal relief.

ORDERING INFORMATION

Device	Nominal Output Voltage	Marking	Package	Shipping†
NCP706MX21TAG	2.1 V	QM	XDFN8 (Pb-Free)	3000 / Tape & Reel
NCP706MX22TAG	2.2 V	QR	XDFN8 (Pb-Free)	3000 / Tape & Reel
NCP706MX295TAG	2.95 V	A2	XDFN8 (Pb-Free)	3000 / Tape & Reel
NCP706MX300TAG	3.0 V	A3	XDFN8 (Pb-Free)	3000 / Tape & Reel
NCP706MX33TAG (In Development)	3.3 V	Q3	XDFN8 (Pb-Free)	3000 / Tape & Reel (Available Soon)

†For information on tape and reel specifications, including part orientation and tape sizes, please refer to our Tape and Reel Packaging Specifications Brochure, BRD8011/D.

NCP706

PACKAGE DIMENSIONS

XDFN8 1.6x1.2, 0.4P CASE 711AS ISSUE D

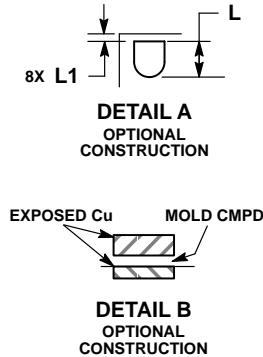
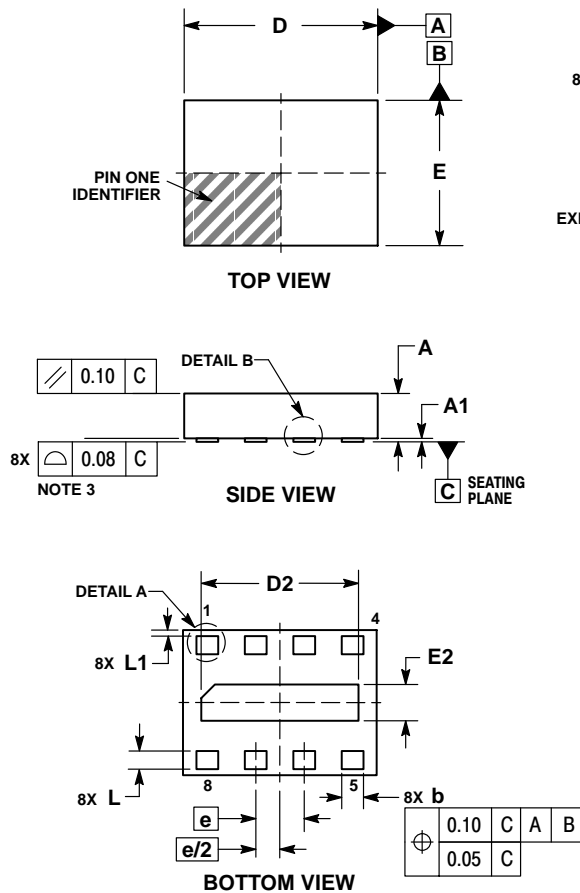

NOTES:

1. DIMENSIONING AND TOLERANCING PER ASME Y14.5M, 1994.
2. CONTROLLING DIMENSION: MILLIMETERS.
3. COPLANARITY APPLIES TO THE EXPOSED PAD AS WELL AS THE TERMINALS.

DIM	MILLIMETERS		
	MIN	NOM	MAX
A	0.300	0.375	0.450
A1	0.000	0.025	0.050
b	0.130	0.180	0.230
D	1.500	1.600	1.700
D2	1.200	1.300	1.400
E	1.100	1.200	1.300
E2	0.200	0.300	0.400
e	0.40 BSC		
L	0.150	0.200	0.250
L1	0.000	0.050	0.100

RECOMMENDED MOUNTING FOOTPRINT*

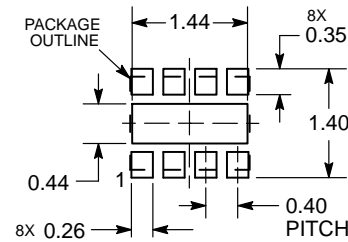

DIMENSIONS: MILLIMETERS

*For additional information on our Pb-Free strategy and soldering details, please download the ON Semiconductor Soldering and Mounting Techniques Reference Manual, SOLDERRM/D.

ON Semiconductor and the are registered trademarks of Semiconductor Components Industries, LLC (SCILLC) or its subsidiaries in the United States and/or other countries. SCILLC owns the rights to a number of patents, trademarks, copyrights, trade secrets, and other intellectual property. A listing of SCILLC's product/patent coverage may be accessed at www.onsemi.com/site/pdf/Patent-Marking.pdf. SCILLC reserves the right to make changes without further notice to any products herein. SCILLC makes no warranty, representation or guarantee regarding the suitability of its products for any particular purpose, nor does SCILLC assume any liability arising out of the application or use of any product or circuit, and specifically disclaims any and all liability, including without limitation special, consequential or incidental damages. "Typical" parameters which may be provided in SCILLC data sheets and/or specifications can and do vary in different applications and actual performance may vary over time. All operating parameters, including "Typicals" must be validated for each customer application by customer's technical experts. SCILLC does not convey any license under its patent rights nor the rights of others. SCILLC products are not designed, intended, or authorized for use as components in systems intended for surgical implant into the body, or other applications intended to support or sustain life, or for any other application in which the failure of the SCILLC product could create a situation where personal injury or death may occur. Should Buyer purchase or use SCILLC products for any such unintended or unauthorized application, Buyer shall indemnify and hold SCILLC and its officers, employees, subsidiaries, affiliates, and distributors harmless against all claims, costs, damages, and expenses, and reasonable attorney fees arising out of, directly or indirectly, any claim of personal injury or death associated with such unintended or unauthorized use, even if such claim alleges that SCILLC was negligent regarding the design or manufacture of the part. SCILLC is an Equal Opportunity/Affirmative Action Employer. This literature is subject to all applicable copyright laws and is not for resale in any manner.

PUBLICATION ORDERING INFORMATION

LITERATURE FULFILLMENT:

Literature Distribution Center for ON Semiconductor
19521 E. 32nd Pkwy, Aurora, Colorado 80011 USA
Phone: 303-675-2175 or 800-344-3860 Toll Free USA/Canada
Fax: 303-675-2176 or 800-344-3867 Toll Free USA/Canada
Email: orderlit@onsemi.com

N. American Technical Support: 800-282-9855 Toll Free
USA/Canada
Europe, Middle East and Africa Technical Support:
Phone: 421 33 790 2910
Japan Customer Focus Center
Phone: 81-3-5817-1050

ON Semiconductor Website: www.onsemi.com

Order Literature: <http://www.onsemi.com/orderlit>

For additional information, please contact your local Sales Representative

Mouser Electronics

Authorized Distributor

Click to View Pricing, Inventory, Delivery & Lifecycle Information:

[ON Semiconductor:](#)

[NCP706MX22TAG](#)