

Contact insert - VC-D1-ST15-PE - 1855018

Please be informed that the data shown in this PDF Document is generated from our Online Catalog. Please find the complete data in the user's documentation. Our General Terms of Use for Downloads are valid (<http://phoenixcontact.com/download>)



Male contact carrier, for turned and rolled crimp contacts, type VC 1, 15-pos. + PE

Product Features

- Positions 15, 30, 50, and 65 are available, in accordance with housing sizes VC 1 - VC 4.
- Contact types meet the requirements of IEC 60352/DIN EN 60352
- Contact carriers have two further capacitive PE contacts
- Pin and socket contacts can be used on both the plug and device sides
- The connection data of 250 V/10 A corresponds to that of the HEAVYCON DD series



Key Commercial Data

Packing unit	1 pc
Minimum order quantity	10 pc
GTIN	 4 017918 159399
Weight per Piece (excluding packing)	28.96 g
Custom tariff number	85366990
Country of origin	Poland

Technical data

Electrical characteristics

Note	Connectors may only be connected/disconnected when under no load.
Rated voltage	250 V
Rated voltage (III/3)	250 V
Rated current	10 A
	10 A
Rated surge voltage	4 kV

Contact insert - VC-D1-ST15-PE - 1855018

Technical data

Electrical characteristics

Number of positions	15
---------------------	----

Ambient conditions

Ambient temperature (operation)	-40 °C ... 125 °C
---------------------------------	-------------------

Mechanical characteristics

Conductor cross section	0.14 mm ² ... 1.5 mm ² (stranded)
Connection cross section AWG	22 ... 16
Stripping length of the individual wire	8 mm
Conductor cross section flexible max.	1.5 mm ²
Insertion/withdrawal cycles	>= 500

General

Type	VC1
Series	VC-D
Connection method	Crimp connection
Flammability rating according to UL 94	V0
Degree of pollution	2
Overvoltage category	III

Material data

Contact carrier material	PA-GF
--------------------------	-------

Standards and Regulations

Connection in acc. with standard	CUL
Flammability rating according to UL 94	V0

Classifications

eCl@ss

eCl@ss 4.0	27140816
eCl@ss 4.1	27140816
eCl@ss 5.0	27143424
eCl@ss 5.1	27143424
eCl@ss 6.0	27143424
eCl@ss 7.0	27440209
eCl@ss 8.0	27440205
eCl@ss 9.0	27440205

Contact insert - VC-D1-ST15-PE - 1855018

Classifications

ETIM

ETIM 2.0	EC000438
ETIM 3.0	EC000438
ETIM 4.0	EC000438
ETIM 5.0	EC000438

UNSPSC

UNSPSC 6.01	30211923
UNSPSC 7.0901	39121522
UNSPSC 11	39121522
UNSPSC 12.01	39121522
UNSPSC 13.2	39121522

Approvals

Approvals

Approvals

UL Recognized / cUL Recognized / EAC / EAC / cULus Recognized

Ex Approvals

Approvals submitted

Approval details

UL Recognized 	
Nominal current I _N	4 A
Nominal voltage U _N	250 V

Contact insert - VC-D1-ST15-PE - 1855018

Approvals

cUL Recognized	
Nominal current I _N	4 A
Nominal voltage U _N	250 V

EAC

EAC

cULus Recognized

Accessories

Accessories

Assembly tool

Contact removal tool - VC-EW 1,6 - 1884869



Contact removal tool, for turned and rolled CK- 1.6-... contacts

Assembly tool - CK1,6/2,5-MWZ - 1676734



Assembly tool, for CK 1.6... crimp contacts for small conductor cross sections

Crimp contact

Contact insert - VC-D1-ST15-PE - 1855018

Accessories

Crimp contact - CK1,6-ED-0,37BU AG - 1663394



Turned 1.6 crimp contact, individual female contact, core diameter 0.14 to 0.37 mm², silver-plated

Crimp contact - CK1,6-ED-0,37BU AU - 1674969



Turned 1.6 crimp contact, individual female contact, core diameter 0.14 to 0.37 mm², gold-plated

Crimp contact - CK1,6-ED-0,50BU AG - 1663404



Turned 1.6 crimp contact, individual female contact, core diameter 0.5 mm², silver-plated

Crimp contact - CK1,6-ED-0,50BU AU - 1674480



Turned 1.6 crimp contact, individual female contact, core diameter 0.5 mm², gold-plated

Crimp contact - CK1,6-ED-0,75BU AG - 1663417



Turned 1.6 crimp contact, individual female contact, core diameter 0.75 mm², silver-plated

Contact insert - VC-D1-ST15-PE - 1855018

Accessories

Crimp contact - CK1,6-ED-0,75BU AU - 1672440



Turned 1.6 crimp contact, individual female contact, core diameter 0.75 mm², gold-plated

Crimp contact - CK1,6-ED-1,00BU AG - 1663420



Turned 1.6 crimp contact, individual female contact, core diameter 0.75 to 1.00 mm², silver-plated

Crimp contact - CK1,6-ED-1,00BU AU - 1674943



Turned 1.6 crimp contact, individual female contact, core diameter 0.75 to 1.00 mm², gold-plated

Crimp contact - CK1,6-ED-1,50BU AG - 1663433



Turned 1.6 crimp contact, individual female contact, core diameter 1.5 mm², silver-plated

Crimp contact - CK1,6-ED-1,50BU AU - 1674930



Turned 1.6 crimp contact, individual female contact, core diameter 1.5 mm², gold-plated

Contact insert - VC-D1-ST15-PE - 1855018

Accessories

Crimp contact - CK1,6-ED-0,37ST AG - 1663336



Turned 1.6 crimp contact, individual male contact, core diameter 0.14 to 0.37 mm², silver-plated

Crimp contact - CK1,6-ED-0,37ST AU - 1674901



Turned 1.6 crimp contact, individual male contact, core diameter 0.14 to 0.37 mm², gold-plated

Crimp contact - CK1,6-ED-0,50ST AG - 1663349



Turned 1.6 crimp contact, individual male contact, core diameter 0.5 mm², silver-plated

Crimp contact - CK1,6-ED-0,50ST AU - 1672453



Turned 1.6 crimp contact, individual male contact, core diameter 0.5 mm², gold-plated

Crimp contact - CK1,6-ED-0,75ST AG - 1663352



Turned 1.6 crimp contact, individual male contact, core diameter 0.75 mm², silver-plated

Contact insert - VC-D1-ST15-PE - 1855018

Accessories

Crimp contact - CK1,6-ED-0,75ST AU - 1674914



Turned 1.6 crimp contact, individual male contact, core diameter 0.75 mm², gold-plated

Crimp contact - CK1,6-ED-1,00ST AG - 1663365



Turned 1.6 crimp contact, individual male contact, core diameter 0.75 to 1.00 mm², silver-plated

Crimp contact - CK1,6-ED-1,00ST AU - 1674888



Turned 1.6 crimp contact, individual male contact, core diameter 0.75 to 1.00 mm², gold-plated

Crimp contact - CK1,6-ED-1,50ST AG - 1663378



Turned 1.6 crimp contact, individual male contact, core diameter 1.5 mm², silver-plated

Crimp contact - CK1,6-BR-0,50ST AG - 1884157



Rolled pin contact, taped, silver-plated, 0.14 mm² ... 0.5 mm², contact entry from left, 2000 pcs. per roll

Contact insert - VC-D1-ST15-PE - 1855018

Accessories

Crimp contact - CK1,6-BR-1,50ST AG - 1884144



Rolled pin contact, taped, silver-plated, 0.5 mm² ... 1.5 mm², contact entry from left, 2000 pcs. per roll

Crimp contact - CK1,6-BR-0,50BU AG - 1884186



Rolled female contact, taped, silver-plated, 0.14 mm² ... 0.5 mm² left contact lead-in, 2000 pieces per roll

Crimp contact - CK1,6-ER-0,50ST AG - 1884092



Rolled 1.6 crimp contact, individual male contact, core diameter 0.5 mm²

Crimp contact - CK1,6-ER-1,50ST AG - 1884089



Rolled male contact, single contacts, silver-plated, 0.5 mm² ... 1.5 mm²

Crimp contact - CK1,6-ER-0,50BU AG - 1884128



Rolled 1.6 crimp contact, individual female contact, core diameter 0.5 mm²

Crimping tool

Contact insert - VC-D1-ST15-PE - 1855018

Accessories

Crimping pliers - CRIMPFOX-1,6/2,5-ED-4,0 - 1687419



Crimping pliers, for turned contacts, CK 1.6 ED... and CK 2.5 ED...

Crimping pliers - CRIMPFOX-1,6-ER-1,50-AT - 1884843



Crimping pliers for rolled contacts CK 1.6-ER... and ...-BR..., 0.5 - 1.5 mm²

Fiber optics contact

Female contact - CK1,6-ED-BU-POF - 1885004



POF fiber optic socket contact, turned, for contact carriers (HC-DD...I-CT... / HC-M-12-MOD... / HC-M-17-MOD...) of CK1,6-ED... contacts

Male contact - CK1,6-ED-ST-POF - 1884995



POF fiber optic pin contact, turned, for contact carriers (HC-DD...I-CT... / HC-M-12-MOD... / HC-M-17-MOD...) of CK1,6-ED... contacts

Panel mounting flange

Mounting flange - VC-D-AF - 1855319



Panel mounting flange for screw locking, for fixing the crimp contact insert to the housing panel, with two M3 threaded holes and one M4 threaded hole

Contact insert - VC-D1-ST15-PE - 1855018

Accessories

Crimping pliers - CRIMPFOX-1,6-ED-POF - 1885017

Crimping pliers, for CK1.6-...POF contacts

Drawings

Contact insert - VC-D1-ST15-PE - 1855018

Dimensional drawing

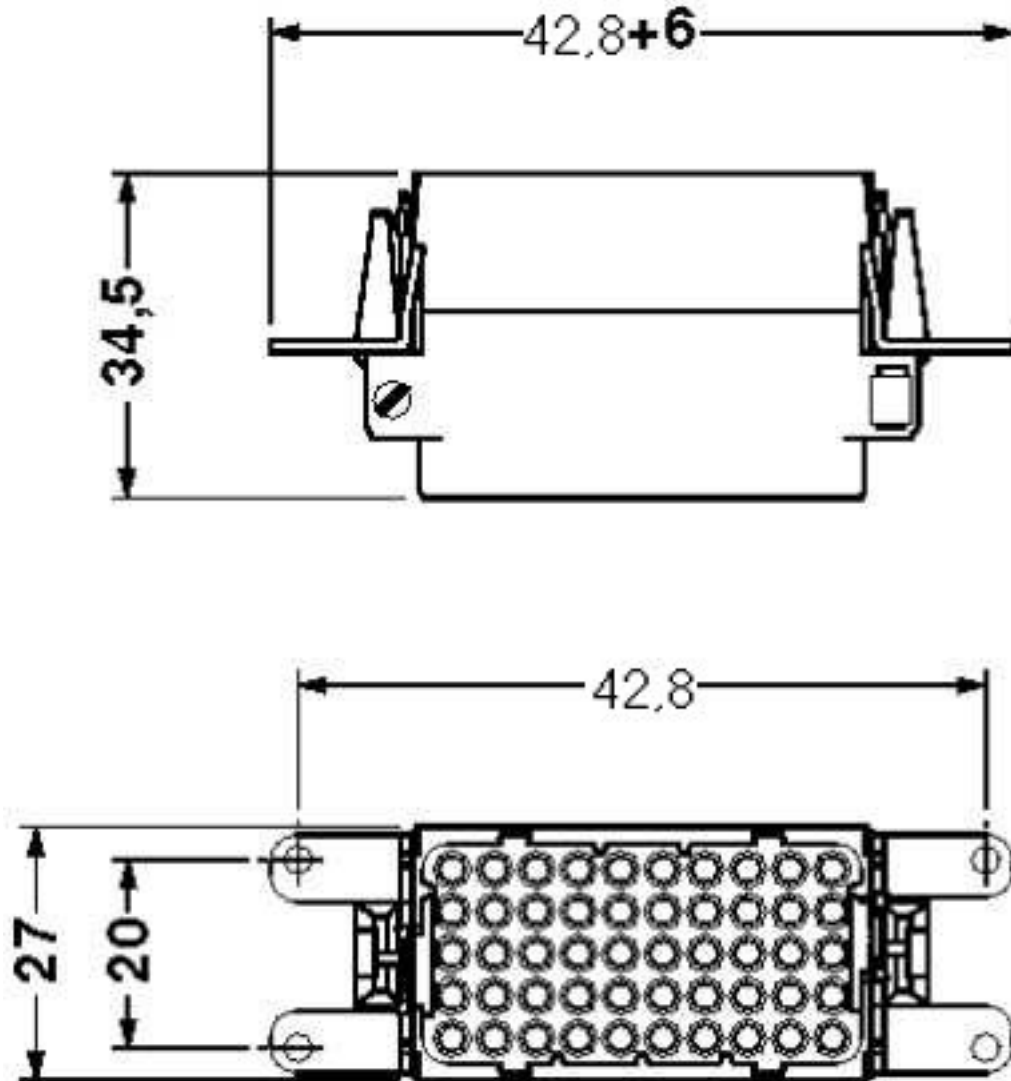

Contact insert

Contact insert - VC-D1-ST15-PE - 1855018

Dimensional drawing

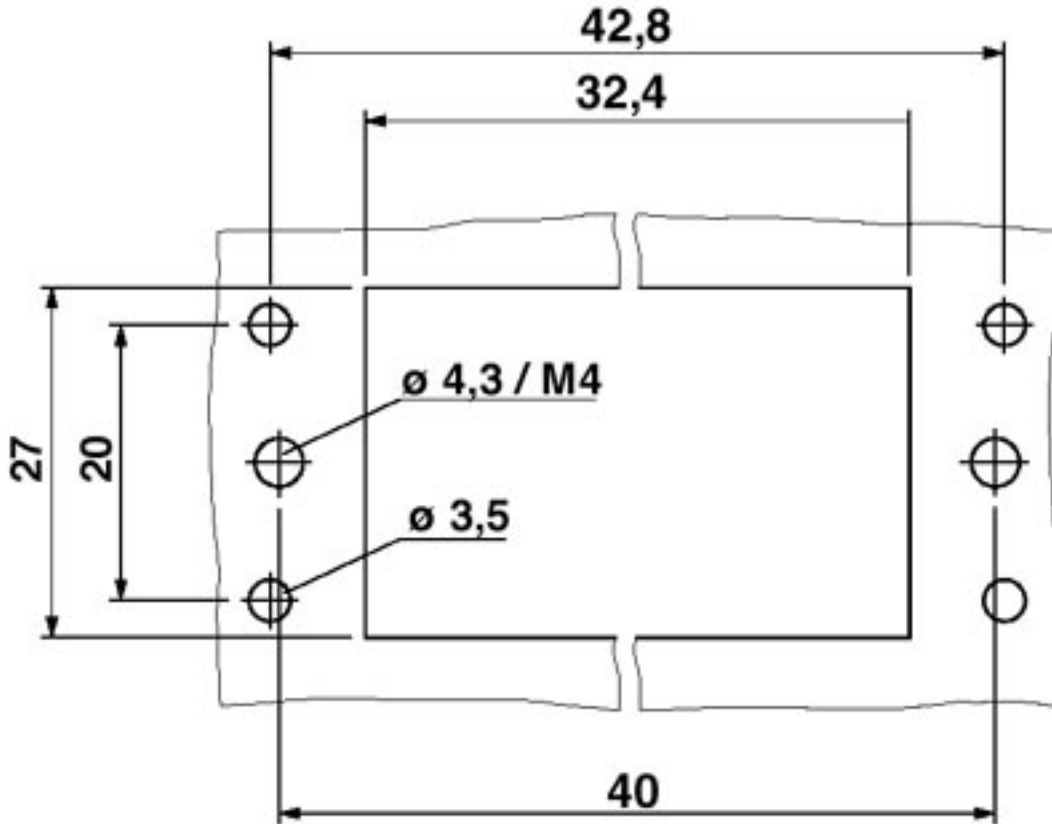

Panel cutout

Mouser Electronics

Authorized Distributor

Click to View Pricing, Inventory, Delivery & Lifecycle Information:

[Phoenix Contact:](#)

[1855018](#)