

Schottky Diode Gen²

$$V_{RRM} = 200V$$

$$I_{FAV} = 2 \times 45A$$

$$V_F = 0.79V$$

High Performance Schottky Diode
Low Loss and Soft Recovery
Common Cathode

Part number

DSA90C200HR

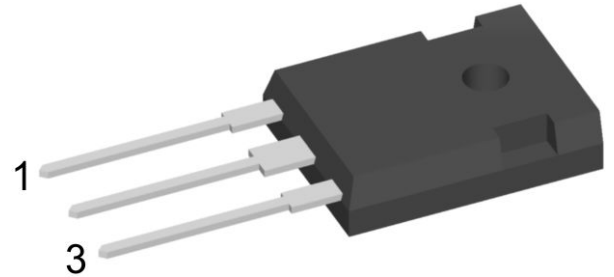

Backside: isolated

 E72873



Features / Advantages:

- Very low V_f
- Extremely low switching losses
- Low I_{rm} values
- Improved thermal behaviour
- High reliability circuit operation
- Low voltage peaks for reduced protection circuits
- Low noise switching

Applications:

- Rectifiers in switch mode power supplies (SMPS)
- Free wheeling diode in low voltage converters

Package: ISO247

- Isolation Voltage: 3600 V~
- Industry standard outline
- RoHS compliant
- Epoxy meets UL 94V-0
- Soldering pins for PCB mounting
- Backside: DCB ceramic
- Reduced weight
- Advanced power cycling

Schottky				Ratings		
Symbol	Definition	Conditions	min.	typ.	max.	Unit
V_{RSM}	max. non-repetitive reverse blocking voltage				200	V
V_{RRM}	max. repetitive reverse blocking voltage				200	V
I_R	reverse current, drain current	$V_R = 200\text{ V}$			2	mA
		$V_R = 200\text{ V}$			5	mA
V_F	forward voltage drop	$I_F = 45\text{ A}$			0.91	V
		$I_F = 90\text{ A}$			1.10	V
		$I_F = 45\text{ A}$			0.79	V
		$I_F = 90\text{ A}$			1.03	V
I_{FAV}	average forward current	$T_C = 145^\circ\text{C}$			45	A
		rectangular $d = 0.5$				
V_{FO}	threshold voltage	} for power loss calculation only			0.49	V
r_F	slope resistance				5.5	mΩ
R_{thJC}	thermal resistance junction to case				0.7	K/W
R_{thCH}	thermal resistance case to heatsink			0.25		K/W
P_{tot}	total power dissipation				215	W
I_{FSM}	max. forward surge current	$t = 10\text{ ms}; (50\text{ Hz}), \text{ sine}; V_R = 0\text{ V}$			600	A
C_J	junction capacitance	$V_R = 24\text{ V } f = 1\text{ MHz}$			394	pF

Package ISO247			Ratings			
Symbol	Definition	Conditions	min.	typ.	max.	Unit
I_{RMS}	RMS current	per terminal ¹⁾			70	A
T_{VJ}	virtual junction temperature		-55		175	°C
T_{op}	operation temperature		-55		150	°C
T_{stg}	storage temperature		-55		150	°C
Weight				6		g
M_D	mounting torque		0.8		1.2	Nm
F_C	mounting force with clip		20		120	N
$d_{Spp/App}$	creepage distance on surface striking distance through air	terminal to terminal	2.7			mm
$d_{Spb/Apb}$		terminal to backside	4.1			mm
V_{ISOL}	isolation voltage	t = 1 second	3600			V
		t = 1 minute	3000			V

Product Marking

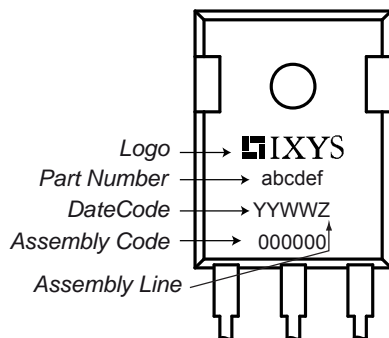

Part number

- D = Diode
- S = Schottky Diode
- A = low VF
- 90 = Current Rating [A]
- C = Common Cathode
- 200 = Reverse Voltage [V]
- HR = ISO247 (3)

Ordering	Part Number	Marking on Product	Delivery Mode	Quantity	Code No.
Standard	DSA90C200HR	DSA90C200HR	Tube	30	508368

Similar Part	Package	Voltage class
DSSK60-02AR	ISOPLUS247 (3)	200
DSSK60-02A	TO-247AD (3)	200

Equivalent Circuits for Simulation

* on die level

$T_{VJ} = 175\text{ °C}$

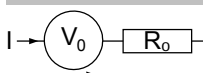

Schottky

$V_{0\ max}$	threshold voltage	0.49	V
$R_{0\ max}$	slope resistance *	2.9	mΩ

Outlines ISO247

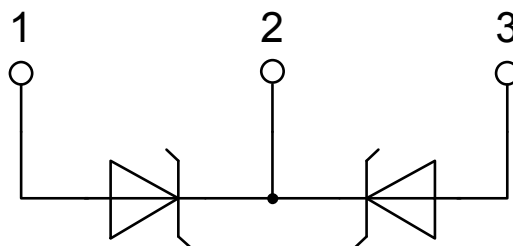
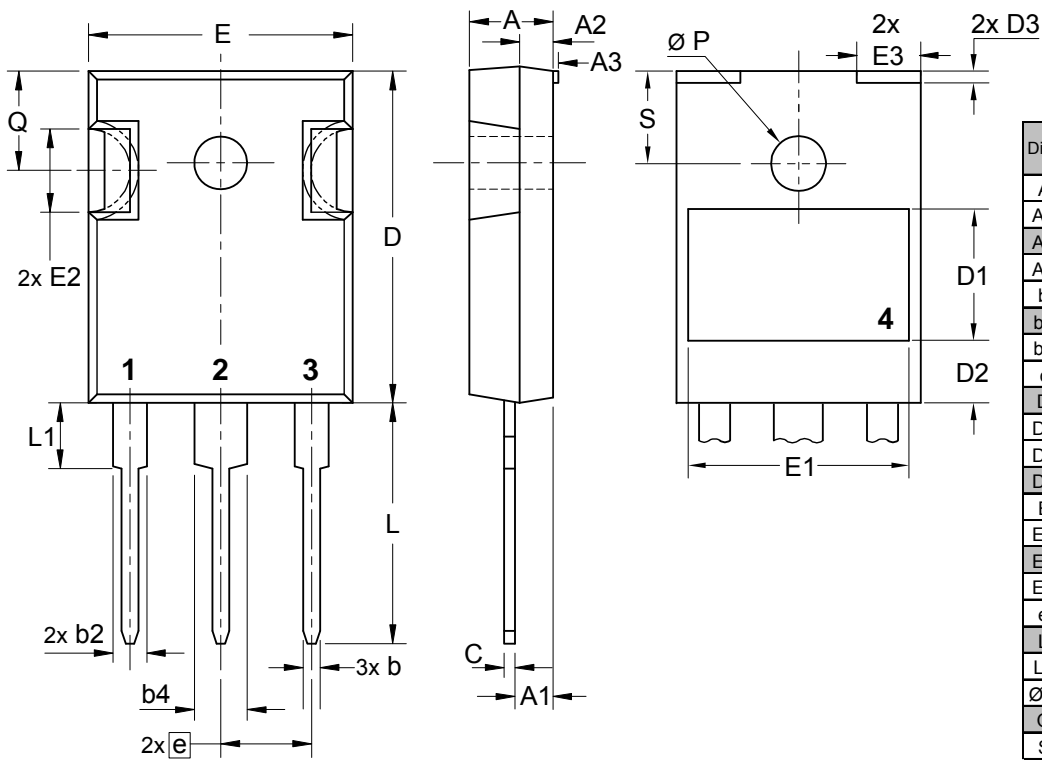

Schottky

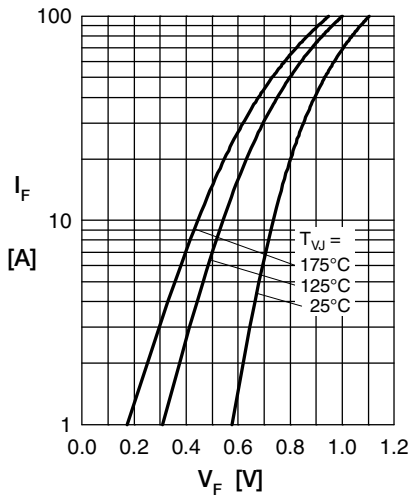

Fig. 1 Max. forward voltage drop characteristics

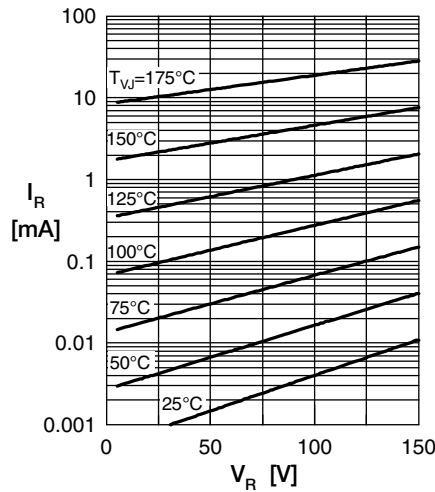

Fig. 2 Typ. reverse current I_R vs. reverse voltage V_R

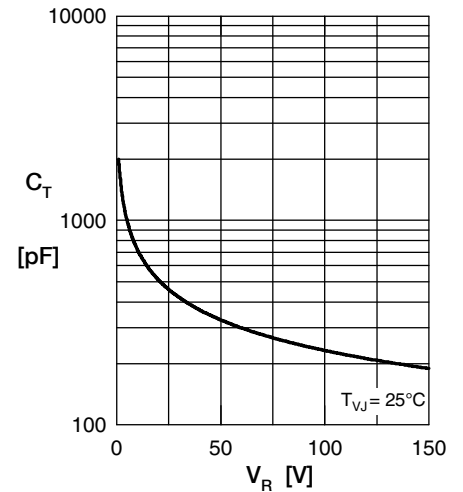

Fig. 3 Typ. junction capacitance C_T vs. reverse voltage V_R

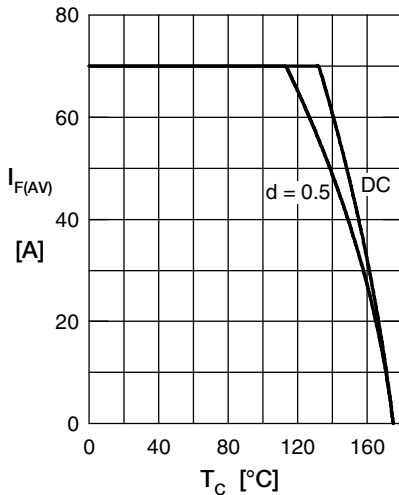

Fig. 4 Avg. forward current $I_{F(AV)}$ vs. case temp. T_C

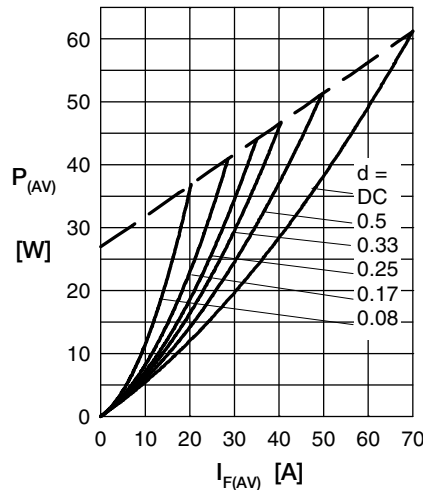

Fig. 5 Forward power loss characteristics

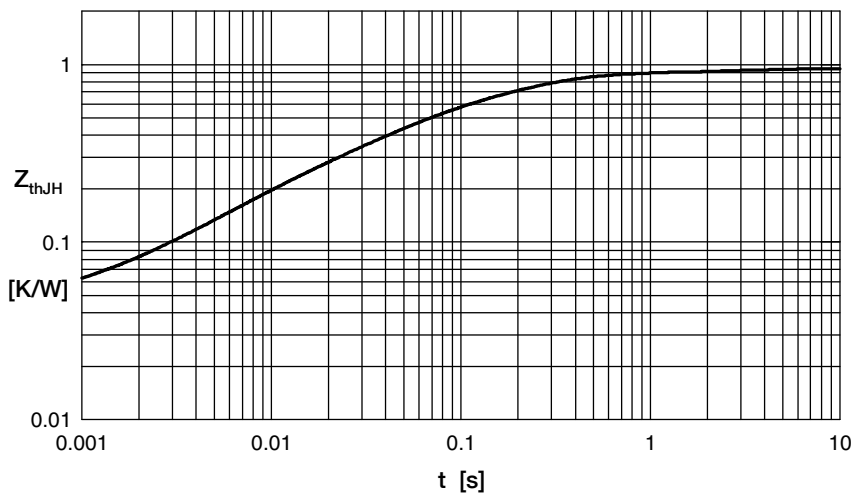

Fig. 6 Transient thermal impedance junction to heatsink

R_{thi}	t_i
0.041	0.0002
0.087	0.0065
0.258	0.037
0.486	0.182
0.078	2.43

Note: All curves are per diode

Mouser Electronics

Authorized Distributor

Click to View Pricing, Inventory, Delivery & Lifecycle Information:

[IXYS:](#)

[DSA90C200HR](#)