

THIS DRAWING IS UNPUBLISHED. RELEASED FOR PUBLICATION  
 © COPYRIGHT - By - ALL RIGHTS RESERVED.

LOC	DIST	REVISIONS					
FT	0	P	LTR	DESCRIPTION	DATE	DWN	APVD
		A3		REVISED PER ECO-11-004917	11MAR11	RK	HMR

NOTES:

MATERIAL:

HOUSING: THERMOPLASTIC, UL94V-0 BLACK.  
 TERMINALS: COPPER ALLOY, BRIGHT TIN PLATED.  
 SCREWS: 6-32, STEEL, ZINC PLATED WITH CLEAR CHROMATE.  
 UNLESS OTHERWISE NOTED.

ELECTRICAL:

MAXIMUM CURRENT: 25A.  
 OPERATING VOLTAGE: 300V.  
 WIRE RANGE: 12-22 AWG.  
 RECOMMENDED TIGHTENING TORQUE: 7 IN-LBS.

ENVIRONMENT:

OPERATING TEMP.: +105°C

- 1 MARKED WITH WHITE PERMANENT INK.
- 2 SCREWS ARE NICKEL PLATED BRASS.
- 3 OBSOLETE PARTS: OBSOLETE CIS STREAMLINING PER D.RENAUD/D.SINISI

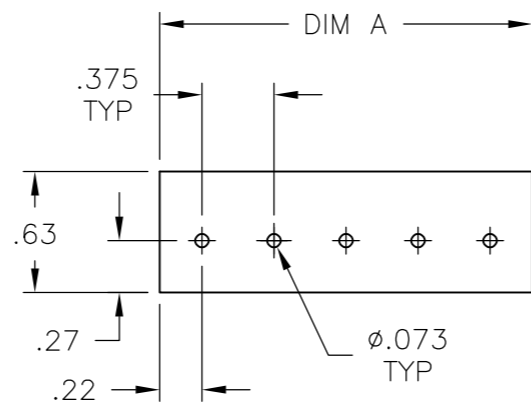
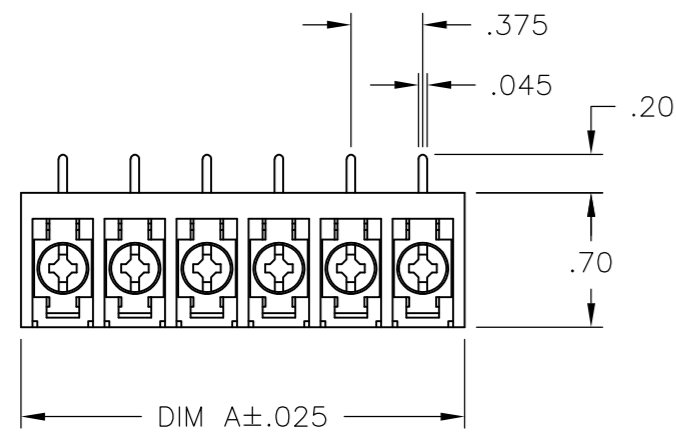

RECOMMENDED PCB LAYOUT

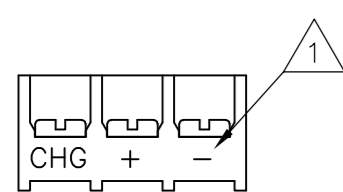
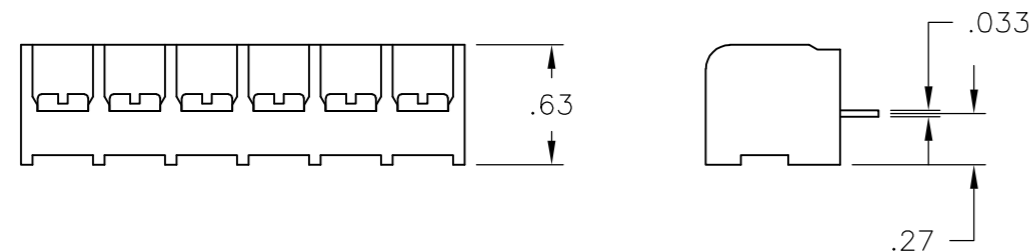

7-1437651-0

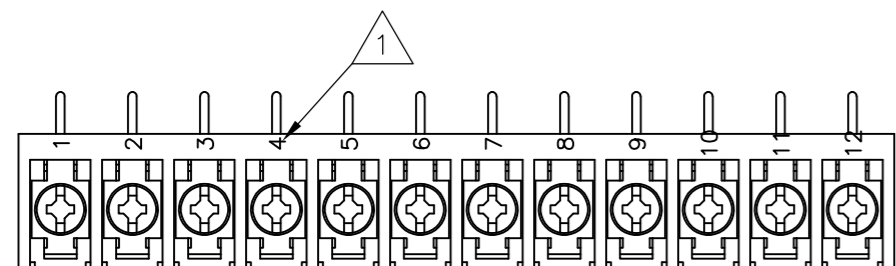

2-796988-3 OBSOLETE

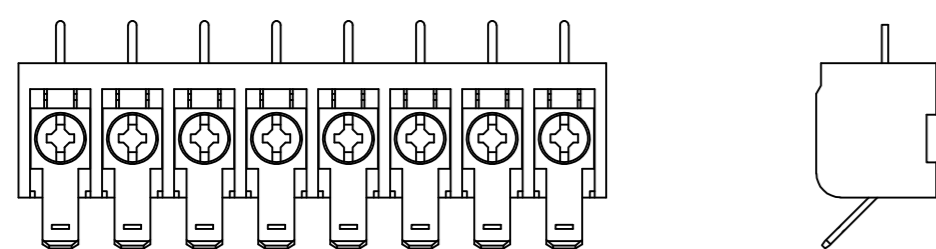

796905-1

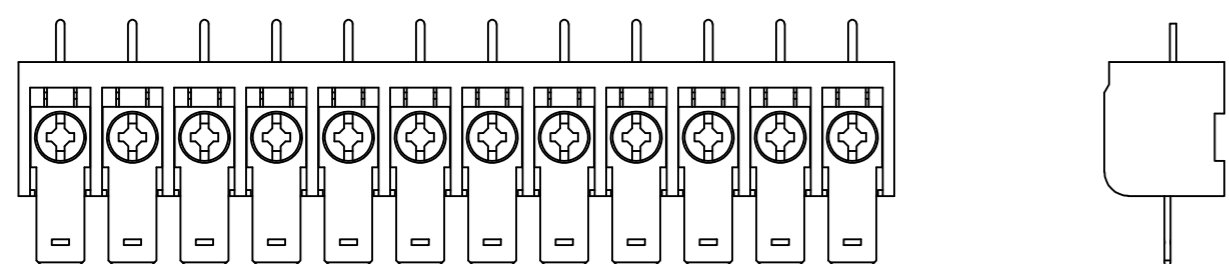

2-796988-9 OBSOLETE

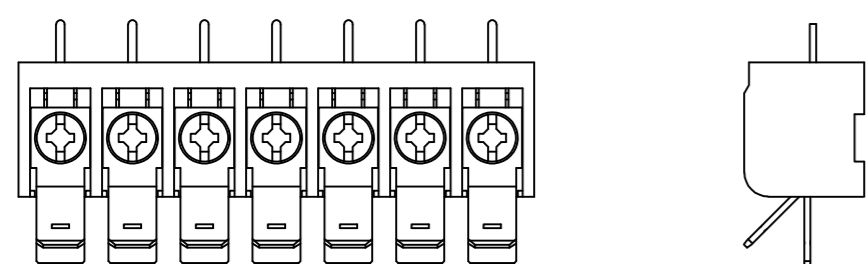

9-1437651-3

DIM. "A"	NO. OF POS.	CATALOG NUMBER	PART NO.
11.311	30	6PCR-30-007	796905-3
10.936	29	6PCR-29-007	796905-2
10.561	28	6PCR-28-007	4-1546158-2
10.186	27	6PCR-27-007	3-1546399-2
9.811	26	6PCR-26-007	3-1546399-1
9.436	25	6PCR-25-007	3-1546399-0
9.061	24	6PCR-24-007	2-1546399-9
8.686	23	6PCR-23-007	2-1546399-8
8.311	22	6PCR-22-007	2-1546399-7
7.936	21	6PCR-21-007	2-1546399-6
7.561	20	6PCR-20-007	2-1546399-5
7.186	19	6PCR-19-007	2-1546399-4
6.811	18	6PCR-18-007	2-1546399-3
6.436	17	6PCR-17-007	2-1546399-2
6.061	16	6PCR-16-007	2-1546399-1
5.686	15	6PCR-15-007	2-1546399-0
5.311	14	6PCR-14-007	1-1546399-9
4.936	13	6PCR-13-007	1-1546399-8
4.561	12	6PCR-12-1381	2-796988-3
4.561	12	6PCR-12-1382	2-796988-9
4.561	12	6PCR-12-007	1-1437652-4
4.186	11	6PCR-11-007	1-1546399-7
3.811	10	6PCR-10-007	1-1546399-6
3.436	9	6PCR-09-007	1-1546399-5
3.061	8	6PCR-08-003	3-1546158-4
3.061	8	6PCR-08-1383	796905-1
3.061	8	6PCR-08-007	3-1546158-3
2.686	7	6PCR-07-014	9-1437651-3
2.686	7	6PCR-07-007	9-1437651-2
2.311	6	6PCR-06-007	8-1437651-8
1.936	5	6PCR-05-007	1-1546399-4
1.561	4	6PCR-04-007	7-1437651-8
1.186	3	6PCR-03-1224	7-1437651-0
1.186	3	6PCR-03-007	1-1546160-9
.811	2	6PCR-02-003	2-1546158-6
.811	2	6PCR-02-007	6-1437651-3

1 SEE FIGURE  
 SEE FIGURE  
 2 SEE FIGURE  
 SEE FIGURE  
 3 SEE FIGURE  
 OBSOLETE

THIS DRAWING IS A CONTROLLED DOCUMENT.		DWN	S SCHLEGEL	5/21/04	<b>TE</b> TE Connectivity	
DIMENSIONS: INCHES		CHK	S YODER	5/21/04		
TOLERANCES UNLESS OTHERWISE SPECIFIED:		APVD	S YODER	5/21/04		
0 PLC ± - 1 PLC ± - 2 PLC ± .02 3 PLC ± .010 4 PLC ± - ANGLES ± - FINISH -		NAME		6PCR-XX-007		
MATERIAL		PRODUCT SPEC	-		SIZE	A2
		APPLICATION SPEC	-		CAGE CODE	00779
		WEIGHT	-		DRAWING NO	C=6-1437651-3
		CUSTOMER DRAWING	-		RESTRICTED TO	-
		SCALE	NTS		SHEET	1 of 1
		REV	A3			

# Mouser Electronics

Authorized Distributor

Click to View Pricing, Inventory, Delivery & Lifecycle Information:

[TE Connectivity:](#)

[9-1437651-2](#)