



DATA SHEET

BIPOLAR ANALOG INTEGRATED CIRCUIT μ PC2710TB

5 V, SUPER MINIMOLD SILICON MMIC MEDIUM OUTPUT POWER AMPLIFIER

DESCRIPTION

The μ PC2710TB is a silicon monolithic integrated circuit designed as PA driver for 900 MHz band cellular telephone tuners. This IC is packaged in super minimold package which is smaller than conventional minimold.

This IC is manufactured using NEC's 20 GHz fr NESAT™ III silicon bipolar process. This process uses silicon nitride passivation film and gold electrodes. These materials can protect chip surface from external pollution and prevent corrosion/migration. Thus, this IC has excellent performance, uniformity and reliability.

FEATURES

- Supply voltage : $V_{CC} = 4.5$ to 5.5 V
- Circuit current : $I_{CC} = 22$ mA TYP. @ $V_{CC} = 5.0$ V
- Power gain : $G_P = 33$ dB TYP. @ $f = 500$ MHz
- Medium output power : $P_{O(sat)} = +13.5$ dBm TYP. @ $f = 500$ MHz
- Upper limit operating frequency : $f_u = 1.0$ GHz TYP. @ 3 dB bandwidth
- Port impedance : input/output 50Ω
- High-density surface mounting : 6-pin super minimold package ($2.0 \times 1.25 \times 0.9$ mm)

APPLICATION

- PA driver for 900 MHz band cellular telephone

ORDERING INFORMATION

Part Number	Package	Marking	Supplying Form
μ PC2710TB-E3	6-pin super minimold	C1F	Embossed tape 8 mm wide. 1, 2, 3 pins face the perforation side of the tape. Qty 3 kpcs/reel.

Remark To order evaluation samples, please contact your nearby sales office.
(Part number for sample order: μ PC2710TB-A)

Caution Electro-static sensitive devices

PIN CONNECTIONS

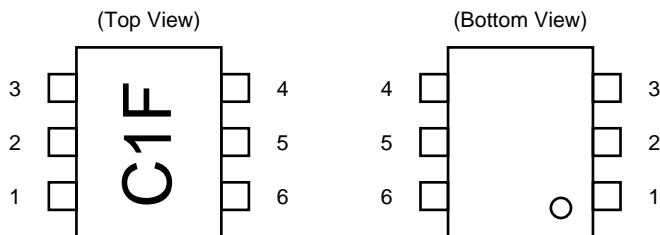

Pin No.	Pin Name
1	INPUT
2	GND
3	GND
4	OUTPUT
5	GND
6	V _{CC}

★ **PRODUCT LINE-UP** (T_A = +25°C, V_{CC} = V_{out} = 5.0 V, Z_s = Z_L = 50 Ω)

Part No.	f _u (GHz)	P _{O(sat)} (dBm)	G _P (dB)	NF (dB)	I _{CC} (mA)	Package	Marking
μPC2708T	2.9	+10.0	15	6.5	26	6-pin minimold	C1D
μPC2708TB						6-pin super minimold	
μPC2709T	2.3	+11.5	23	5.0	25	6-pin minimold	C1E
μPC2709TB						6-pin super minimold	
μPC2710T	1.0	+13.5	33	3.5	22	6-pin minimold	C1F
μPC2710TB						6-pin super minimold	
μPC2776T	2.7	+8.5	23	6.0	25	6-pin minimold	C2L
μPC2776TB						6-pin super minimold	

Remark Typical performance. Please refer to **ELECTRICAL CHARACTERISTICS** in detail.

Notice The package size distinguishes between minimold and super minimold.

SYSTEM APPLICATION EXAMPLE

EXAMPLE OF 900 MHz BAND DIGITAL CELLULAR TELEPHONE

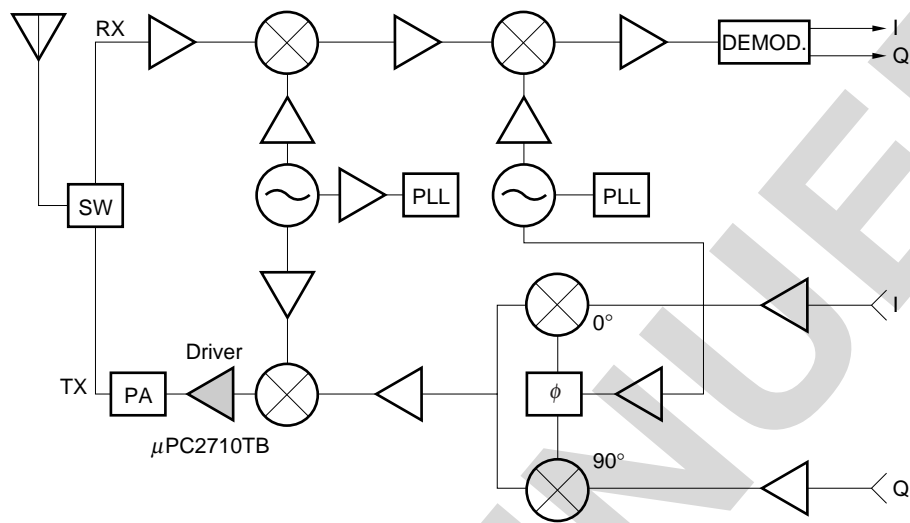

DISCONTINUED

PIN EXPLANATION

Pin No.	Pin Name	Applied Voltage (V)	Pin Voltage (V) <small>Note</small>	Function and Applications	Internal Equivalent Circuit
1	INPUT	–	0.90	Signal input pin. A internal matching circuit, configured with resistors, enables 50 Ω connection over a wide band. A multi-feedback circuit is designed to cancel the deviations of h_{FE} and resistance. This pin must be coupled to signal source with capacitor for DC cut.	
2 3 5	GND	0	–	Ground pin. This pin should be connected to system ground with minimum inductance. Ground pattern on the board should be formed as wide as possible. All the ground pins must be connected together with wide ground pattern to decrease impedance difference.	
4	OUTPUT	Voltage as same as V_{CC} through external inductor	–	Signal output pin. The inductor must be attached between V_{CC} and output pins to supply current to the internal output transistors.	
6	V_{CC}	4.5 to 5.5	–	Power supply pin, which biases the internal input transistor. This pin should be externally equipped with bypass capacitor to minimize its impedance.	

Note Pin voltage is measured at $V_{CC} = 5.0$ V

ABSOLUTE MAXIMUM RATINGS

Parameter	Symbol	Conditions	Ratings	Unit
Supply Voltage	V_{CC}	$T_A = +25^\circ\text{C}$, pin 4 and pin 6	5.8	V
Total Circuit Current	I_{CC}	$T_A = +25^\circ\text{C}$	60	mA
Power Dissipation	P_D	Mounted on double-sided copper clad 50 × 50 × 1.6 mm epoxy glass PWB $T_A = +85^\circ\text{C}$	270	mW
Operating Ambient Temperature	T_A		-40 to +85	$^\circ\text{C}$
Storage Temperature	T_{stg}		-55 to +150	$^\circ\text{C}$
Input Power	P_{in}	$T_A = +25^\circ\text{C}$	+10	dBm

RECOMMENDED OPERATING RANGE

Parameter	Symbol	MIN.	TYP.	MAX.	Unit	Remark
Supply Voltage	V_{CC}	4.5	5.0	5.5	V	The same voltage should be applied to pin 4 and pin 6.

ELECTRICAL CHARACTERISTICS

(Unless otherwise specified, $T_A = +25^\circ\text{C}$, $V_{CC} = V_{out} = 5.0\text{ V}$, $Z_s = Z_L = 50\ \Omega$)

Parameter	Symbol	Test Conditions	MIN.	TYP.	MAX.	Unit
Circuit Current	I_{CC}	No signal	16	22	29	mA
Power Gain	G_P	$f = 500\text{ MHz}$	30	33	36.5	dB
Saturated Output Power	$P_{O(sat)}$	$f = 500\text{ MHz}$, $P_{in} = -8\text{ dBm}$	+11.0	+13.5	-	dBm
Noise Figure	NF	$f = 500\text{ MHz}$	-	3.5	5.0	dB
Upper Limit Operating Frequency	f_u	3 dB down below flat gain at $f = 0.1\text{ GHz}$	0.7	1.0	-	GHz
Isolation	ISL	$f = 500\text{ MHz}$	34	39	-	dB
Input Return Loss	RL_{in}	$f = 500\text{ MHz}$	3	6	-	dB
Output Return Loss	RL_{out}	$f = 500\text{ MHz}$	9	12	-	dB
Gain Flatness	ΔG_P	$f = 0.1\text{ to }0.6\text{ GHz}$	-	± 0.8	-	dB

TEST CIRCUIT

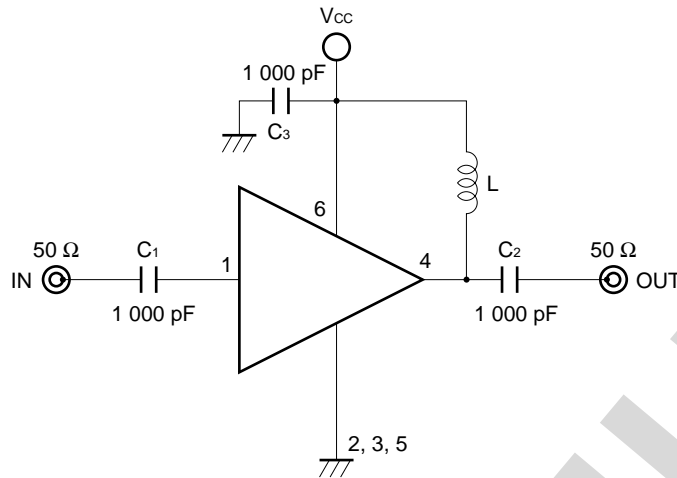

COMPONENTS OF TEST CIRCUIT FOR MEASURING ELECTRICAL CHARACTERISTICS

	Type	Value
C ₁ , C ₂	Bias Tee	1 000 pF
C ₃	Capacitor	1 000 pF
L	Bias Tee	1 000 nH

EXAMPLE OF ACTURAL APPLICATION COMPONENTS

	Type	Value	Operating Frequency
C ₁ to C ₃	Chip Capacitor	1 000 pF	100 MHz or higher
L	Chip Inductor	300 nH	10 MHz or higher
		100 nH	100 MHz or higher
		10 nH	1.0 GHz or higher

INDUCTOR FOR THE OUTPUT PIN

The internal output transistor of this IC consumes 20 mA, to output medium power. To supply current for output transistor, connect an inductor between the Vcc pin (pin 6) and output pin (pin 4). Select large value inductance, as listed above.

The inductor has both DC and AC effects. In terms of DC, the inductor biases the output transistor with minimum voltage drop to output enable high level. In terms of AC, the inductor make output-port impedance higher to get enough gain. In this case, large inductance and Q is suitable.

CAPACITORS FOR THE Vcc, INPUT AND OUTPUT PINS

Capacitors of 1000 pF are recommendable as the bypass capacitor for the Vcc pin and the coupling capacitors for the input and output pins.

The bypass capacitor connected to the Vcc pin is used to minimize ground impedance of Vcc pin. So, stable bias can be supplied against Vcc fluctuation.

The coupling capacitors, connected to the input and output pins, are used to cut the DC and minimize RF serial impedance. Their capacitance are therefore selected as lower impedance against a 50 Ω load. The capacitors thus perform as high pass filters, suppressing low frequencies to DC.

To obtain a flat gain from 100 MHz upwards, 1000 pF capacitors are used in the test circuit. In the case of under 10 MHz operation, increase the value of coupling capacitor such as 10000 pF. Because the coupling capacitors are determined by equation, $C = 1/(2 \pi Rf_c)$.

ILLUSTRATION OF THE TEST CIRCUIT ASSEMBLED ON EVALUATION BOARD

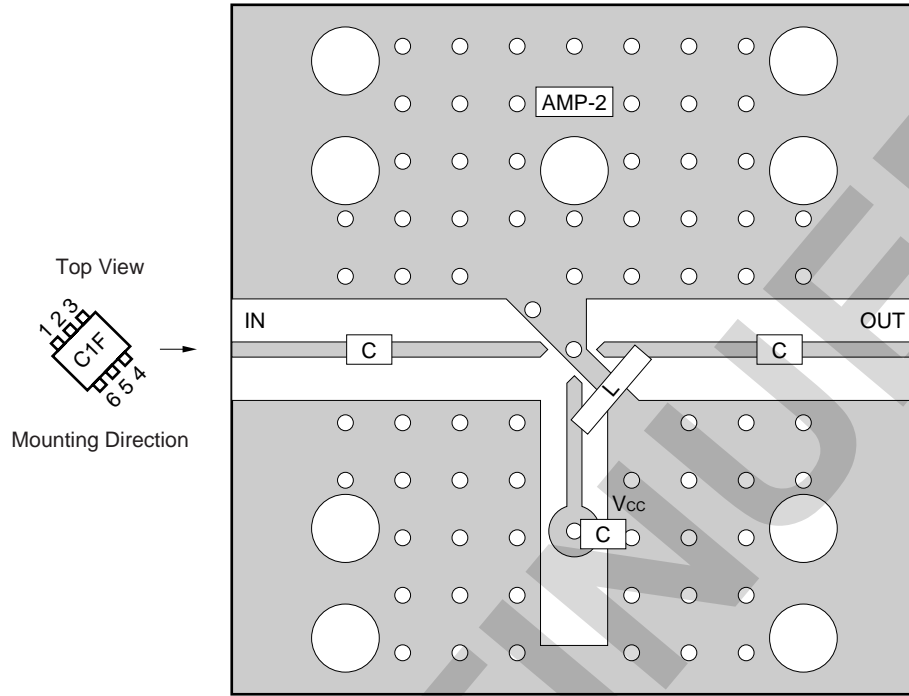

COMPONENT LIST

	Value
C	1 000 pF
L	300 nH

Notes

1. 30 × 30 × 0.4 mm double sided copper clad polyimide board.
2. Back side: GND pattern
3. Solder plated on pattern
4. \circ \bigcirc : Through holes

For more information on the use of this IC, refer to the following application note: **USAGE AND APPLICATION OF 6-PIN SUPER MINIMOLD SILICON MEDIUM-POWER HIGH-FREQUENCY AMPLIFIER MMIC (P13252E).**

TYPICAL CHARACTERISTICS (Unless otherwise specified, $T_A = +25^\circ\text{C}$)

CIRCUIT CURRENT vs. SUPPLY VOLTAGE

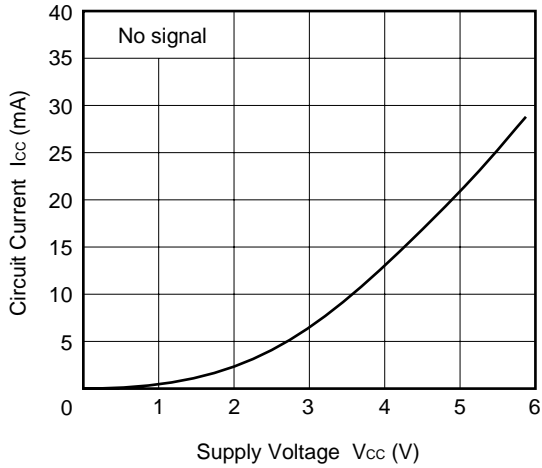

CIRCUIT CURRENT vs. OPERATING AMBIENT TEMPERATURE

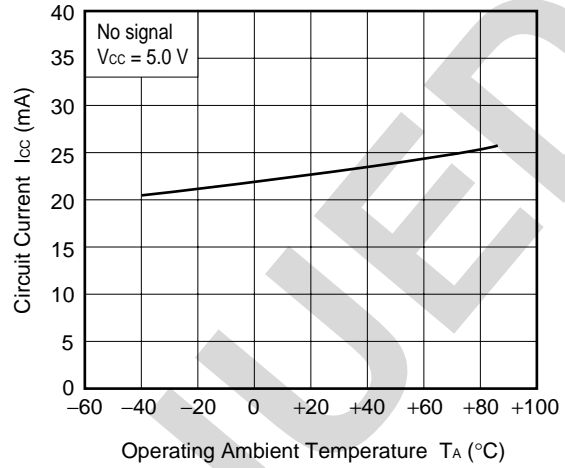

NOISE FIGURE, POWER GAIN vs. FREQUENCY

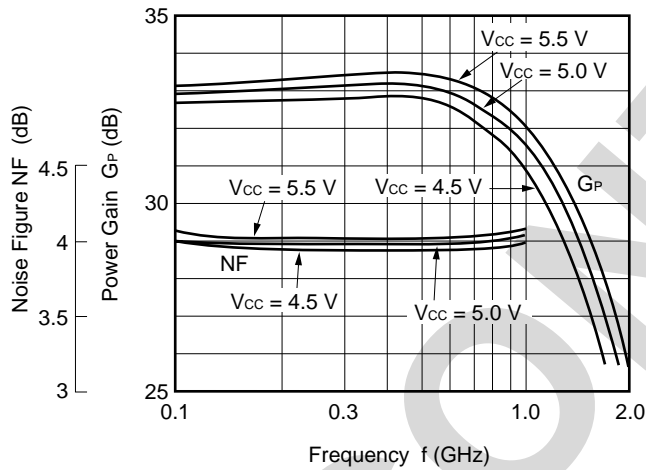

POWER GAIN vs. FREQUENCY

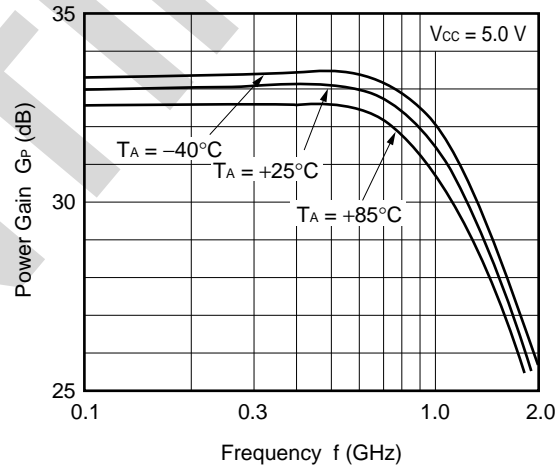

ISOLATION vs. FREQUENCY

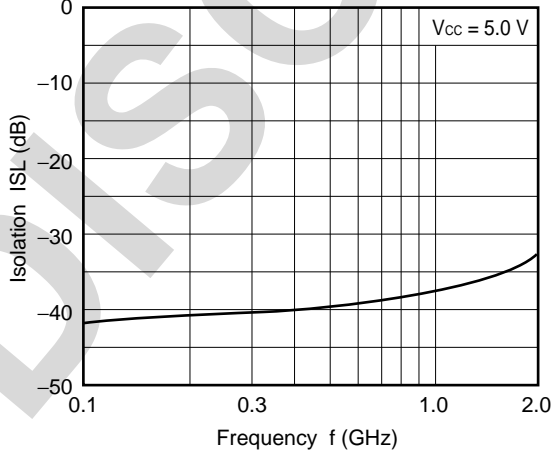

INPUT RETURN LOSS, OUTPUT RETURN LOSS vs. FREQUENCY

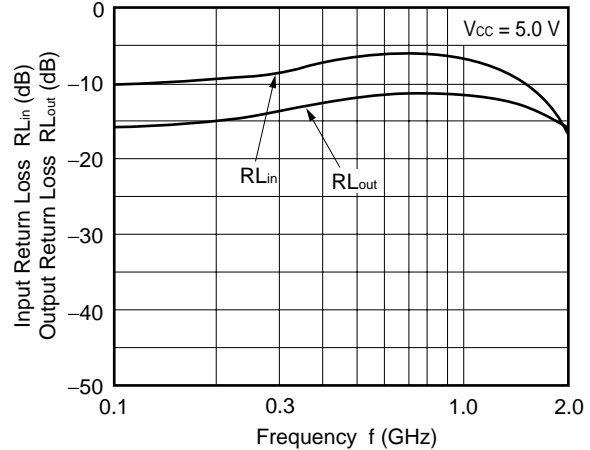

OUTPUT POWER vs. INPUT POWER

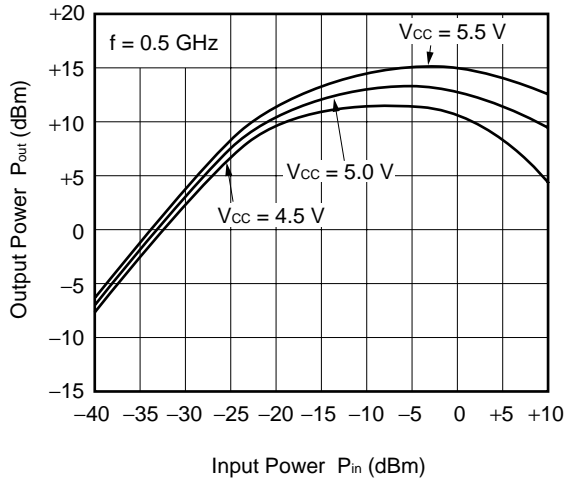

OUTPUT POWER vs. INPUT POWER

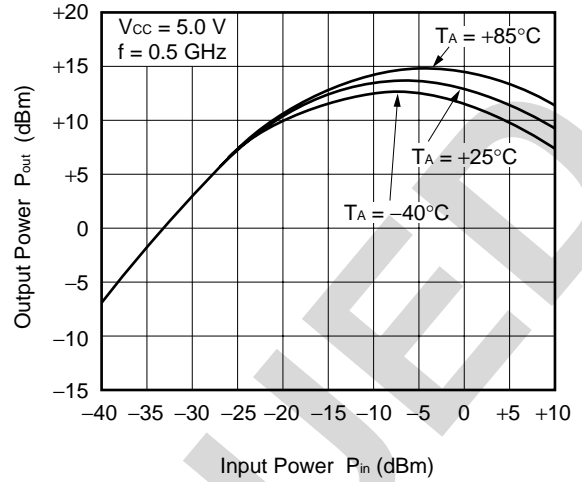

OUTPUT POWER vs. INPUT POWER

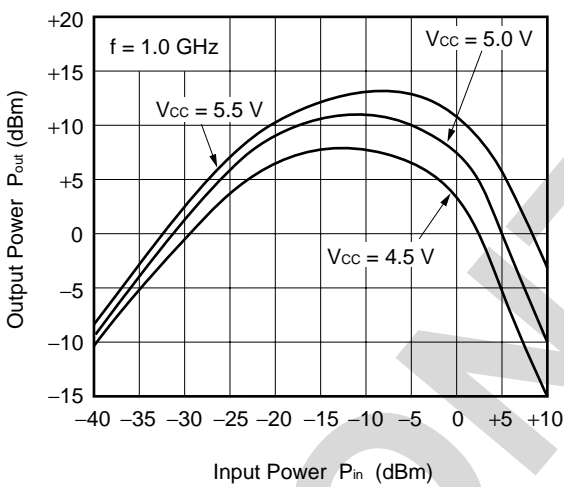

OUTPUT POWER vs. INPUT POWER

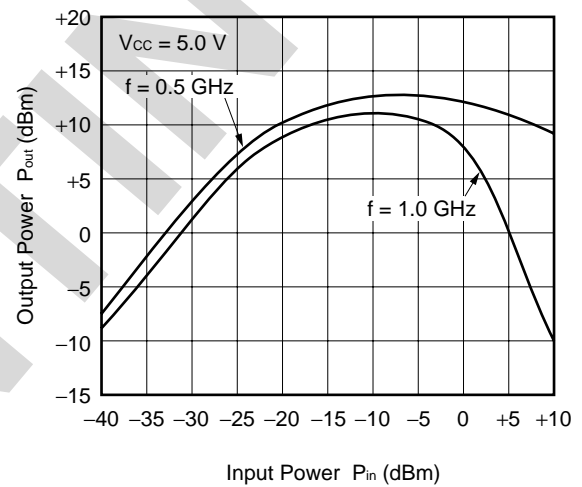

SATURATED OUTPUT POWER vs. FREQUENCY

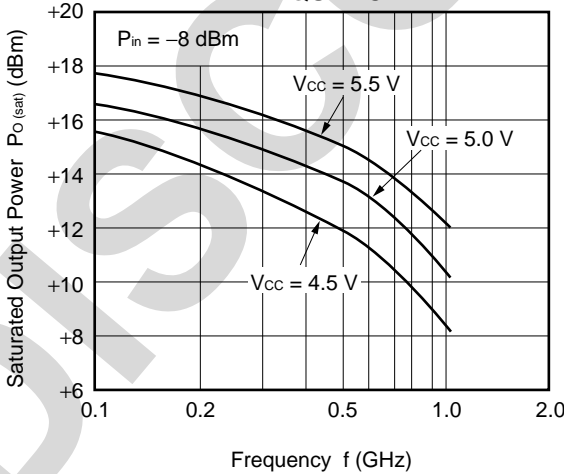

3RD ORDER INTERMODULATION DISTORTION vs. OUTPUT POWER OF EACH TONE

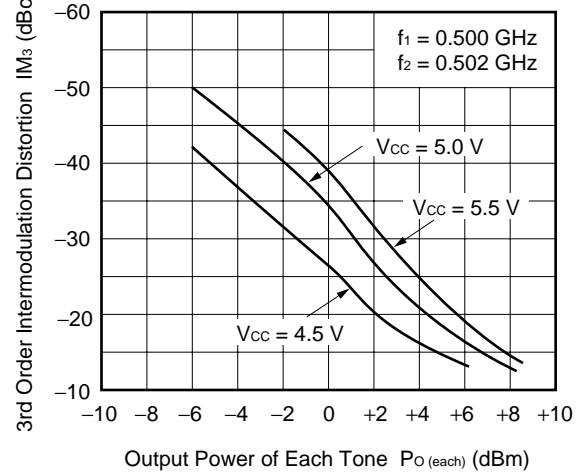

S-PARAMETERS ($T_A = +25^\circ\text{C}$, $V_{CC} = V_{out} = 5.0\text{ V}$)

S₁₁-FREQUENCY

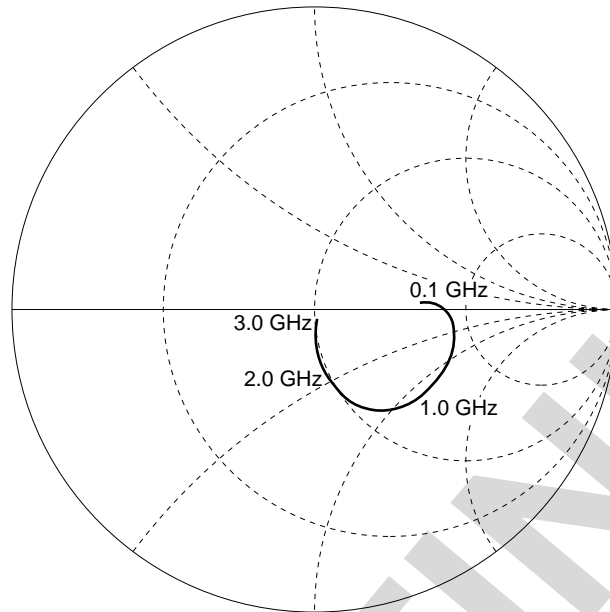

S₂₂- FREQUENCY

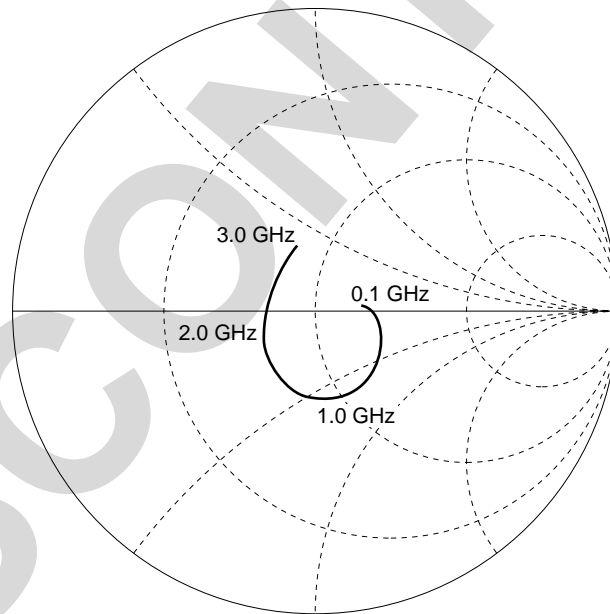

TYPICAL S-PARAMETER VALUES (T_A = +25°C)

V_{CC} = V_{out} = 5.0 V, I_{CC} = 22 mA

FREQUENCY MHz	S ₁₁		S ₂₁		S ₁₂		S ₂₂		K
	MAG.	ANG.	MAG.	ANG.	MAG.	ANG.	MAG.	ANG.	
100.0000	0.306	2.5	43.072	-8.4	0.012	15.2	0.156	2.7	1.08
200.0000	0.324	5.2	43.517	-17.1	0.010	10.7	0.164	2.1	1.17
300.0000	0.356	5.3	44.432	-26.5	0.010	20.2	0.185	0.3	1.10
400.0000	0.400	2.5	45.513	-36.9	0.012	26.9	0.225	-5.5	0.92
500.0000	0.439	-3.3	45.679	-48.1	0.012	27.0	0.255	-15.4	0.85
600.0000	0.469	-10.2	45.670	-59.7	0.013	31.3	0.283	-27.6	0.77
700.0000	0.481	-17.9	44.793	-71.8	0.014	34.9	0.301	-40.2	0.74
800.0000	0.488	-26.7	43.016	-84.3	0.014	27.9	0.312	-54.9	0.74
900.0000	0.479	-34.5	40.519	-96.0	0.013	26.6	0.316	-67.7	0.78
1000.0000	0.465	-41.2	37.946	-107.3	0.016	30.8	0.311	-79.5	0.79
1100.0000	0.448	-49.3	35.122	-117.9	0.016	26.6	0.307	-92.2	0.85
1200.0000	0.417	-54.9	32.108	-128.0	0.015	39.5	0.282	-104.6	0.99
1300.0000	0.387	-61.2	29.221	-137.0	0.015	39.7	0.270	-115.5	1.12
1400.0000	0.350	-65.2	26.656	-145.8	0.015	50.2	0.248	-127.0	1.27
1500.0000	0.316	-70.8	23.895	-153.9	0.013	50.8	0.236	-136.2	1.56
1600.0000	0.292	-74.0	21.576	-161.6	0.016	56.6	0.215	-145.3	1.49
1700.0000	0.256	-76.9	19.567	-168.1	0.015	69.0	0.200	-155.2	1.71
1800.0000	0.245	-80.5	17.743	-174.4	0.018	61.7	0.196	-162.5	1.59
1900.0000	0.215	-82.9	16.040	-179.6	0.017	70.0	0.180	-173.4	1.88
2000.0000	0.201	-85.6	14.717	-173.5	0.021	71.2	0.175	-178.1	1.71
2100.0000	0.177	-84.4	13.475	-168.8	0.020	83.0	0.166	-172.0	1.94
2200.0000	0.161	-88.8	12.327	-163.1	0.021	76.7	0.171	-167.7	1.99
2300.0000	0.145	-88.7	11.154	-158.7	0.022	87.9	0.159	-159.1	2.08
2400.0000	0.124	-90.3	10.262	-154.4	0.023	81.4	0.164	-154.0	2.15
2500.0000	0.113	-89.8	9.490	-150.4	0.025	91.9	0.158	-147.0	2.19
2600.0000	0.107	-91.9	8.793	-146.4	0.028	88.7	0.166	-141.8	2.06
2700.0000	0.091	-92.2	8.149	-142.4	0.030	93.4	0.175	-135.7	2.13
2800.0000	0.081	-94.9	7.652	-138.9	0.031	92.1	0.183	-131.6	2.13
2900.0000	0.067	-97.4	7.134	-135.1	0.031	93.0	0.191	-123.4	2.26
3000.0000	0.055	-103.8	6.726	-131.5	0.039	88.3	0.200	-118.9	1.97
3100.0000	0.039	-95.6	6.295	-128.4	0.039	89.6	0.203	-111.5	2.08

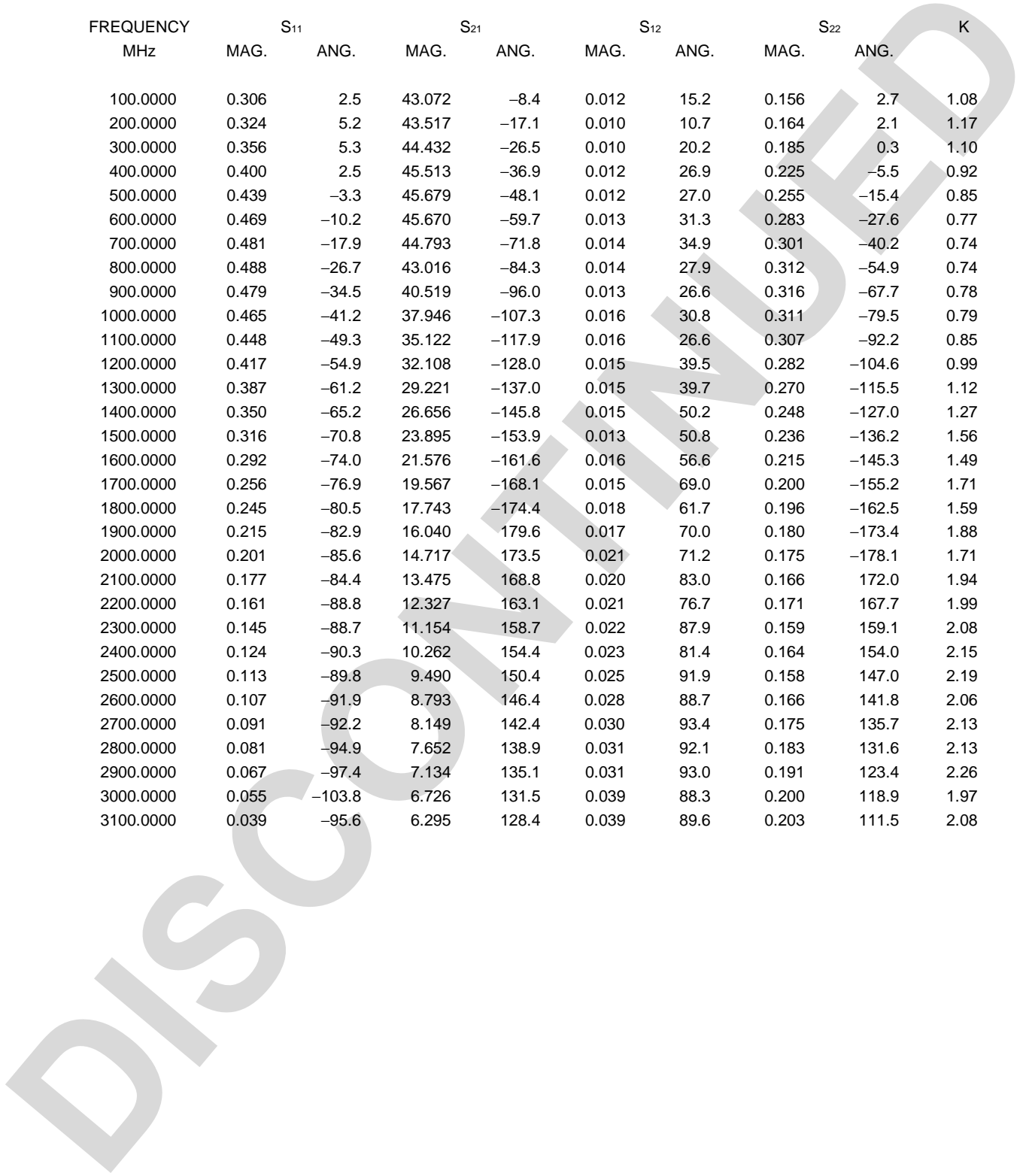

★ PACKAGE DIMENSIONS

6-PIN SUPER MINIMOLD (UNIT: mm)

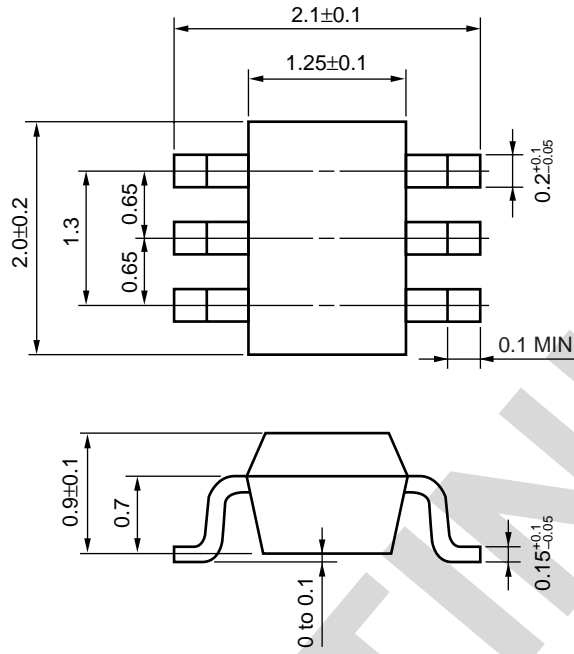

DISCONTINUED

NOTES ON CORRECT USE

- (1) Observe precautions for handling because of electro-static sensitive devices.
- (2) Form a ground pattern as widely as possible to minimize ground impedance (to prevent undesired oscillation).
All the ground pins must be connected together with wide ground pattern to decrease impedance difference.
- (3) The bypass capacitor should be attached to Vcc line.
- (4) The inductor must be attached between Vcc and output pins. The inductance value should be determined in accordance with desired frequency.
- (5) The DC cut capacitor must be attached to input pin and output pin.

RECOMMENDED SOLDERING CONDITIONS

This product should be soldered under the following recommended conditions.

Soldering Method	Soldering Conditions	Recommended Condition Symbol
Infrared Reflow	Package peak temperature: 235°C or below Time: 30 seconds or less (at 210°C) Count: 3, Exposure limit: None ^{Note}	IR35-00-3
VPS	Package peak temperature: 215°C or below Time: 40 seconds or less (at 200°C) Count: 3, Exposure limit: None ^{Note}	VP15-00-3
Wave Soldering	Soldering bath temperature: 260°C or below Time: 10 seconds or less Count: 1, Exposure limit: None ^{Note}	WS60-00-1
Partial Heating	Pin temperature: 300°C or below Time: 3 seconds or less (per side of device) Exposure limit: None ^{Note}	–

Note After opening the dry pack, keep it in a place below 25°C and 65% RH for the allowable storage period.

Caution Do not use different soldering methods together (except for partial heating).

For details of recommended soldering conditions for surface mounting, refer to information document SEMICONDUCTOR DEVICE MOUNTING TECHNOLOGY MANUAL (C10535E).

NOTICE

1. Descriptions of circuits, software and other related information in this document are provided only to illustrate the operation of semiconductor products and application examples. You are fully responsible for the incorporation of these circuits, software, and information in the design of your equipment. California Eastern Laboratories and Renesas Electronics assumes no responsibility for any losses incurred by you or third parties arising from the use of these circuits, software, or information.
2. California Eastern Laboratories has used reasonable care in preparing the information included in this document, but California Eastern Laboratories does not warrant that such information is error free. California Eastern Laboratories and Renesas Electronics assumes no liability whatsoever for any damages incurred by you resulting from errors in or omissions from the information included herein.
3. California Eastern Laboratories and Renesas Electronics do not assume any liability for infringement of patents, copyrights, or other intellectual property rights of third parties by or arising from the use of Renesas Electronics products or technical information described in this document. No license, express, implied or otherwise, is granted hereby under any patents, copyrights or other intellectual property rights of California Eastern Laboratories or Renesas Electronics or others.
4. You should not alter, modify, copy, or otherwise misappropriate any Renesas Electronics product, whether in whole or in part. California Eastern Laboratories and Renesas Electronics assume no responsibility for any losses incurred by you or third parties arising from such alteration, modification, copy or otherwise misappropriation of Renesas Electronics product.
5. Renesas Electronics products are classified according to the following two quality grades: "Standard" and "High Quality". The recommended applications for each Renesas Electronics product depends on the product's quality grade, as indicated below. "Standard": Computers; office equipment; communications equipment; test and measurement equipment; audio and visual equipment; home electronic appliances; machine tools; personal electronic equipment; and industrial robots etc. "High Quality": Transportation equipment (automobiles, trains, ships, etc.); traffic control systems; anti-disaster systems; anti-crime systems; and safety equipment etc. Renesas Electronics products are neither intended nor authorized for use in products or systems that may pose a direct threat to human life or bodily injury (artificial life support devices or systems, surgical implantations etc.), or may cause serious property damages (nuclear reactor control systems, military equipment etc.). You must check the quality grade of each Renesas Electronics product before using it in a particular application. You may not use any Renesas Electronics product for any application for which it is not intended. California Eastern Laboratories and Renesas Electronics shall not be in any way liable for any damages or losses incurred by you or third parties arising from the use of any Renesas Electronics product for which the product is not intended by California Eastern Laboratories or Renesas Electronics.
6. You should use the Renesas Electronics products described in this document within the range specified by California Eastern Laboratories, especially with respect to the maximum rating, operating supply voltage range, movement power voltage range, heat radiation characteristics, installation and other product characteristics. California Eastern Laboratories shall have no liability for malfunctions or damages arising out of the use of Renesas Electronics products beyond such specified ranges.
7. Although Renesas Electronics endeavors to improve the quality and reliability of its products, semiconductor products have specific characteristics such as the occurrence of failure at a certain rate and malfunctions under certain use conditions. Further, Renesas Electronics products are not subject to radiation resistance design. Please be sure to implement safety measures to guard them against the possibility of physical injury, and injury or damage caused by fire in the event of the failure of a Renesas Electronics product, such as safety design for hardware and software including but not limited to redundancy, fire control and malfunction prevention, appropriate treatment for aging degradation or any other appropriate measures. Because the evaluation of microcomputer software alone is very difficult, please evaluate the safety of the final products or systems manufactured by you.
8. Please contact a California Eastern Laboratories sales office for details as to environmental matters such as the environmental compatibility of each Renesas Electronics product. Please use Renesas Electronics products in compliance with all applicable laws and regulations that regulate the inclusion or use of controlled substances, including without limitation, the EU RoHS Directive. California Eastern Laboratories and Renesas Electronics assume no liability for damages or losses occurring as a result of your noncompliance with applicable laws and regulations.
9. Renesas Electronics products and technology may not be used for or incorporated into any products or systems whose manufacture, use, or sale is prohibited under any applicable domestic or foreign laws or regulations. You should not use Renesas Electronics products or technology described in this document for any purpose relating to military applications or use by the military, including but not limited to the development of weapons of mass destruction. When exporting the Renesas Electronics products or technology described in this document, you should comply with the applicable export control laws and regulations and follow the procedures required by such laws and regulations.
10. It is the responsibility of the buyer or distributor of California Eastern Laboratories, who distributes, disposes of, or otherwise places the Renesas Electronics product with a third party, to notify such third party in advance of the contents and conditions set forth in this document, California Eastern Laboratories and Renesas Electronics assume no responsibility for any losses incurred by you or third parties as a result of unauthorized use of Renesas Electronics products.
11. This document may not be reproduced or duplicated in any form, in whole or in part, without prior written consent of California Eastern Laboratories.
12. Please contact a California Eastern Laboratories sales office if you have any questions regarding the information contained in this document or Renesas Electronics products, or if you have any other inquiries.

NOTE 1: "Renesas Electronics" as used in this document means Renesas Electronics Corporation and also includes its majority-owned subsidiaries.

NOTE 2: "Renesas Electronics product(s)" means any product developed or manufactured by or for Renesas Electronics.

NOTE 3: Products and product information are subject to change without notice.

CEL Headquarters • 4590 Patrick Henry Drive, Santa Clara, CA 95054 • Phone (408) 919-2500 • www.cel.com

For a complete list of sales offices, representatives and distributors,
Please visit our website: www.cel.com/contactus

Mouser Electronics

Authorized Distributor

Click to View Pricing, Inventory, Delivery & Lifecycle Information:

CEL:

[UPC2710TB-EVAL](#) [UPC2710TB-A](#)