

## 35 A, 600 V ultrafast IGBT with low drop diode

### Features

- Improved  $E_{off}$  at elevated temperature
- Low  $C_{RES} / C_{IES}$  ratio (no cross-conduction susceptibility)
- Low  $V_F$  soft recovery antiparallel diode

### Applications

- Welding
- Induction heating
- Resonant converters

### Description

This ultrafast IGBT is developed using a new planar technology to yield a device with tighter switching energy variation ( $E_{off}$ ) versus temperature. The suffix "W" denotes a subset of products designed for high switching frequency operation (over 100 kHz).

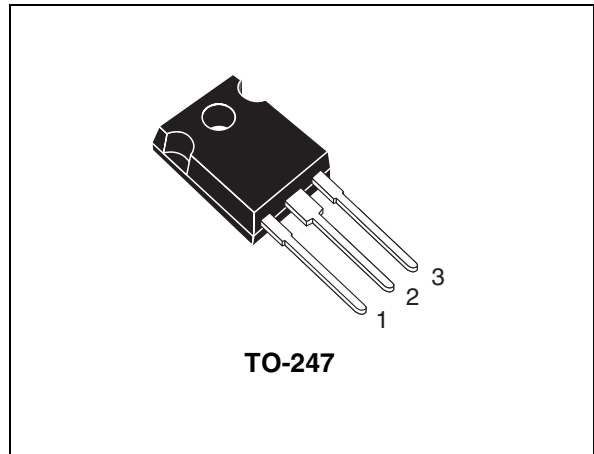

**Figure 1. Internal schematic diagram**

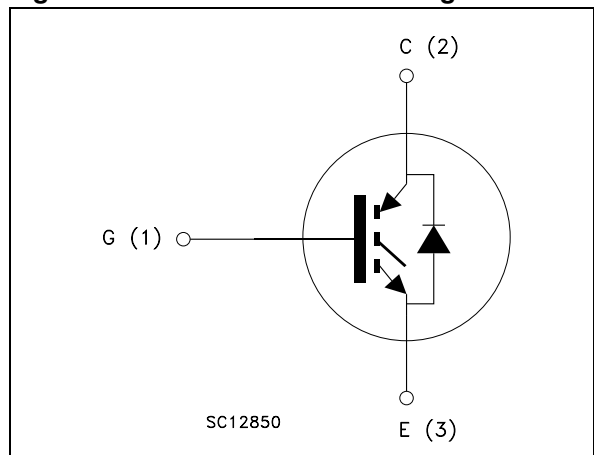

**Table 1. Device summary**

Order code	Marking	Package	Packaging
STGW35HF60WDI	GW35HF60WDI	TO-247	Tube
STGWA35HF60WDI	35HF60WDI	TO-247 long leads	

# Contents

<b>1</b>	<b>Electrical ratings</b> .....	<b>2</b>
<b>2</b>	<b>Electrical characteristics</b> .....	<b>3</b>
	2.1 Electrical characteristics (curves) .....	5
<b>3</b>	<b>Test circuits</b> .....	<b>8</b>
<b>4</b>	<b>Package mechanical data</b> .....	<b>9</b>
<b>5</b>	<b>Revision history</b> .....	<b>13</b>

# 1 Electrical ratings

**Table 2. Absolute maximum ratings**

Symbol	Parameter	Value		Unit
		TO-247	TO-247 long leads	
V <sub>CES</sub>	Collector-emitter voltage (V <sub>GE</sub> = 0)	600		V
I <sub>C</sub> <sup>(1)</sup>	Continuous collector current at T <sub>C</sub> = 25 °C	60	70	A
I <sub>C</sub> <sup>(1)</sup>	Continuous collector current at T <sub>C</sub> = 100 °C	35	40	A
I <sub>CL</sub> <sup>(2)</sup>	Turn-off latching current	80		A
I <sub>CP</sub> <sup>(3)</sup>	Pulsed collector current	150		A
V <sub>GE</sub>	Gate-emitter voltage	± 20		V
I <sub>F</sub>	Diode RMS forward current at T <sub>C</sub> = 25 °C	30		A
I <sub>FSM</sub>	Surge non repetitive forward current t <sub>p</sub> = 10 ms sinusoidal	130		A
P <sub>TOT</sub>	Total dissipation at T <sub>C</sub> = 25 °C	200	260	W
T <sub>stg</sub>	Storage temperature	- 55 to 150		°C
T <sub>j</sub>	Operating junction temperature			

1. Calculated according to the iterative formula:

$$I_C(T_C) = \frac{T_{j(max)} - T_C}{R_{thj-c} \times V_{CE(sat)(max)}(T_{j(max)}, I_C(T_C))}$$

2. Pulse width limited by maximum junction temperature and turn-off within RBSOA

3. V<sub>CLAMP</sub> = 80% (V<sub>CES</sub>), V<sub>GE</sub> = 15 V, R<sub>G</sub> = 10 Ω, T<sub>J</sub> = 150 °C

**Table 3. Thermal data**

Symbol	Parameter	Value		Unit
		TO-247	TO-247 long leads	
R <sub>thj-case</sub>	Thermal resistance junction-case IGBT	0.63	0.48	°C/W
	Thermal resistance junction-case diode	1.5		°C/W
R <sub>thj-amb</sub>	Thermal resistance junction-ambient	50		°C/W

## 2 Electrical characteristics

( $T_J = 25\text{ °C}$  unless otherwise specified)

**Table 4. Static**

Symbol	Parameter	Test conditions	Min.	Typ.	Max.	Unit
$V_{(BR)CES}$	Collector-emitter breakdown voltage ( $V_{GE} = 0$ )	$I_C = 1\text{ mA}$	600			V
$V_{CE(sat)}$	Collector-emitter saturation voltage	$V_{GE} = 15\text{ V}, I_C = 20\text{ A}$ $V_{GE} = 15\text{ V}, I_C = 20\text{ A}, T_J = 125\text{ °C}$		1.9 1.65	2.5	V V
$V_{GE(th)}$	Gate threshold voltage	$V_{CE} = V_{GE}, I_C = 1\text{ mA}$	3.75		5.75	V
$I_{CES}$	Collector cut-off current ( $V_{GE} = 0$ )	$V_{CE} = 600\text{ V}$ $V_{CE} = 600\text{ V}, T_J = 125\text{ °C}$			250 1	$\mu\text{A}$ mA
$I_{GES}$	Gate-emitter leakage current ( $V_{CE} = 0$ )	$V_{GE} = \pm 20\text{ V}$			$\pm 100$	nA
$g_{fs}$	Forward transconductance	$V_{CE} = 15\text{ V}, I_C = 20\text{ A}$		15		S

**Table 5. Dynamic**

Symbol	Parameter	Test conditions	Min.	Typ.	Max.	Unit
$C_{ies}$ $C_{oes}$ $C_{res}$	Input capacitance Output capacitance Reverse transfer capacitance	$V_{CE} = 25\text{ V}, f = 1\text{ MHz},$ $V_{GE} = 0$	-	2400 235 50	-	pF pF pF
$Q_g$ $Q_{ge}$ $Q_{gc}$	Total gate charge Gate-emitter charge Gate-collector charge	$V_{CE} = 390\text{ V}, I_C = 20\text{ A},$ $V_{GE} = 15\text{ V},$ (see <a href="#">Figure 17</a> )	-	140 13 52	-	nC nC nC

**Table 6. Switching on/off (inductive load)**

Symbol	Parameter	Test conditions	Min.	Typ.	Max.	Unit
$t_{d(on)}$ $t_r$ $(di/dt)_{on}$	Turn-on delay time Current rise time Turn-on current slope	$V_{CC} = 390\text{ V}, I_C = 20\text{ A}$ $R_G = 10\ \Omega, V_{GE} = 15\text{ V},$ (see <a href="#">Figure 16</a> )	-	30 15 1650	-	ns ns A/ $\mu\text{s}$
$t_{d(on)}$ $t_r$ $(di/dt)_{on}$	Turn-on delay time Current rise time Turn-on current slope	$V_{CC} = 390\text{ V}, I_C = 20\text{ A}$ $R_G = 10\ \Omega, V_{GE} = 15\text{ V},$ $T_J = 125\text{ °C}$ (see <a href="#">Figure 16</a> )	-	30 15 1600	-	ns ns A/ $\mu\text{s}$

**Table 6. Switching on/off (inductive load)**

$t_r(V_{off})$	Off voltage rise time	$V_{CC} = 390\text{ V}$ , $I_C = 20\text{ A}$ , $R_{GE} = 10\ \Omega$ , $V_{GE} = 15\text{ V}$ (see <a href="#">Figure 16</a> )	-	30	-	ns
$t_{d(off)}$	Turn-off delay time		-	175	-	ns
$t_f$	Current fall time		-	40	-	ns
$t_r(V_{off})$	Off voltage rise time	$V_{CC} = 390\text{ V}$ , $I_C = 20\text{ A}$ , $R_{GE} = 10\ \Omega$ , $V_{GE} = 15\text{ V}$ , $T_J = 125\text{ }^\circ\text{C}$ (see <a href="#">Figure 16</a> )	-	50	-	ns
$t_{d(off)}$	Turn-off delay time		-	225	-	ns
$t_f$	Current fall time		-	70	-	ns

**Table 7. Switching energy (inductive load)**

Symbol	Parameter	Test conditions	Min.	Typ.	Max.	Unit
$E_{off}$	Turn-off switching losses	$V_{CC} = 390\text{ V}$ , $I_C = 20\text{ A}$ $R_G = 10\ \Omega$ , $V_{GE} = 15\text{ V}$ , (see <a href="#">Figure 18</a> )	-	185		$\mu\text{J}$
$E_{off}$	Turn-off switching losses	$V_{CC} = 390\text{ V}$ , $I_C = 20\text{ A}$ $R_G = 10\ \Omega$ , $V_{GE} = 15\text{ V}$ , $T_J = 125\text{ }^\circ\text{C}$ , (see <a href="#">Figure 18</a> )	-	350	530	$\mu\text{J}$

**Table 8. Collector-emitter diode**

Symbol	Parameter	Test conditions	Min.	Typ.	Max.	Unit
$V_F$	Forward on-voltage	$I_F = 20\text{ A}$ $I_F = 20\text{ A}$ , $T_J = 125\text{ }^\circ\text{C}$	-	1.3 1.1	1.7	V V
$t_{rr}$	Reverse recovery time	$I_F = 20\text{ A}$ , $V_R = 50\text{ V}$ ,	-	85	-	ns
$Q_{rr}$	Reverse recovery charge	$di/dt = 100\text{ A}/\mu\text{s}$	-	240	-	nC
$I_{rrm}$	Reverse recovery current	(see <a href="#">Figure 19</a> )	-	5.2	-	A
$t_{rr}$	Reverse recovery time	$I_F = 20\text{ A}$ , $V_R = 50\text{ V}$ ,	-	230	-	ns
$Q_{rr}$	Reverse recovery charge	$T_J = 125\text{ }^\circ\text{C}$ , $di/dt = 100\text{ A}/\mu\text{s}$	-	930	-	nC
$I_{rrm}$	Reverse recovery current	(see <a href="#">Figure 19</a> )	-	8.7	-	A

## 2.1 Electrical characteristics (curves)

Figure 2. Output characteristics

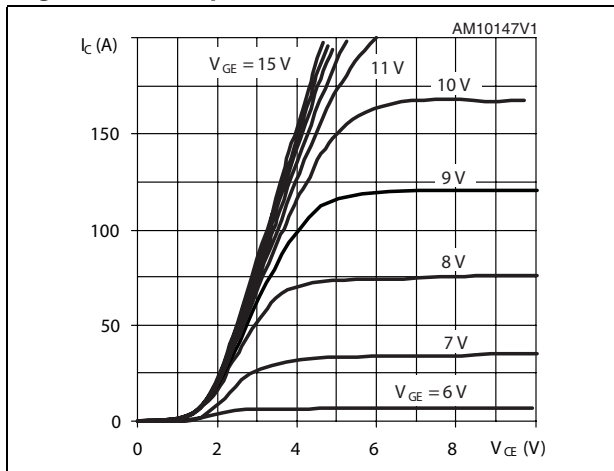

Figure 3. Transfer characteristics

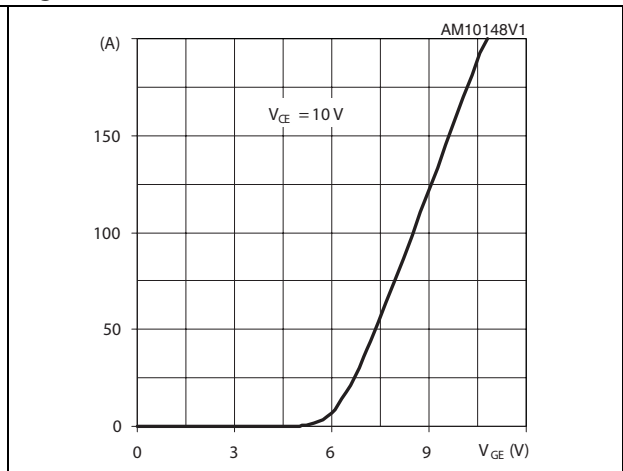

Figure 4. Normalized  $V_{CE(sat)}$  vs.  $I_c$

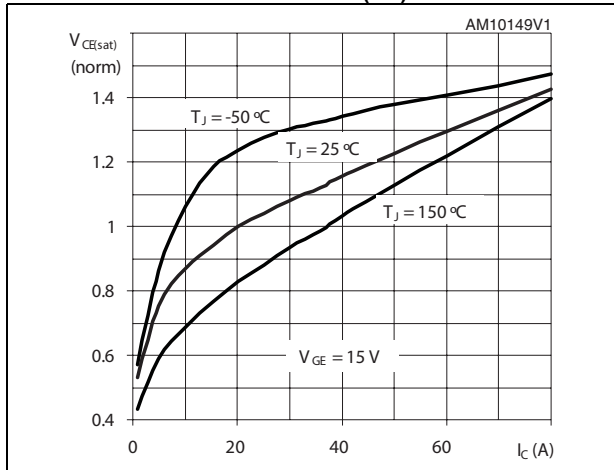

Figure 5. Normalized  $V_{CE(sat)}$  vs. temperature

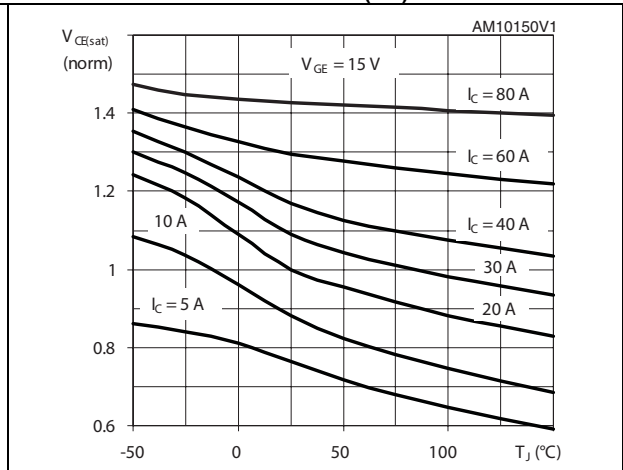

Figure 6. Normalized breakdown voltage vs. temperature

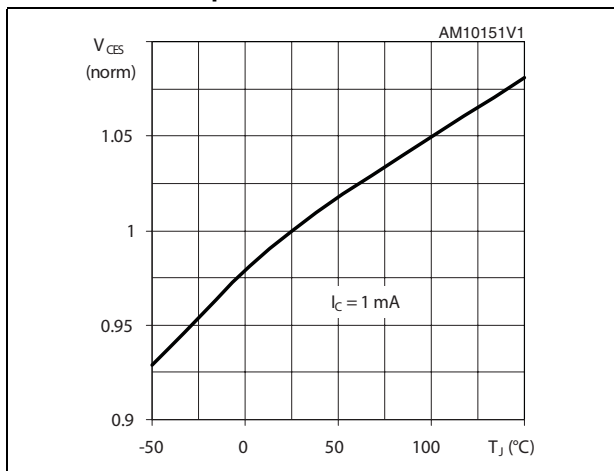

Figure 7. Normalized gate threshold voltage vs. temperature

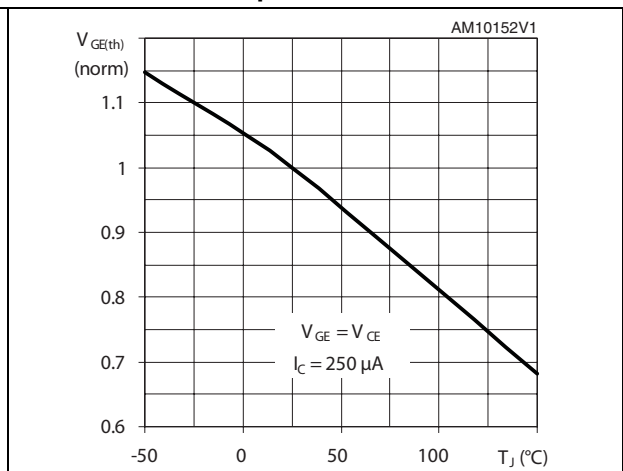

Figure 8. Gate charge vs. gate-emitter voltage

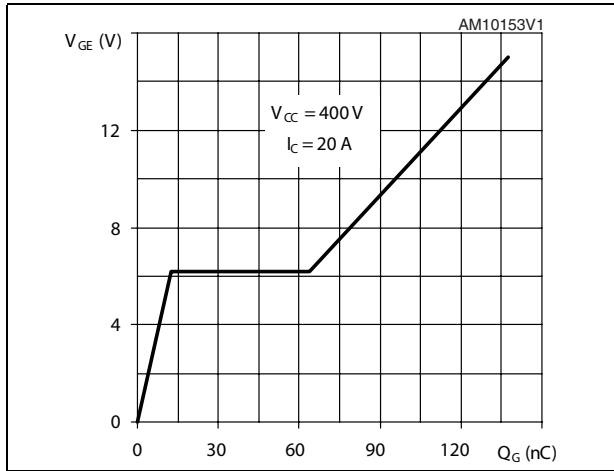

Figure 9. Capacitance variations

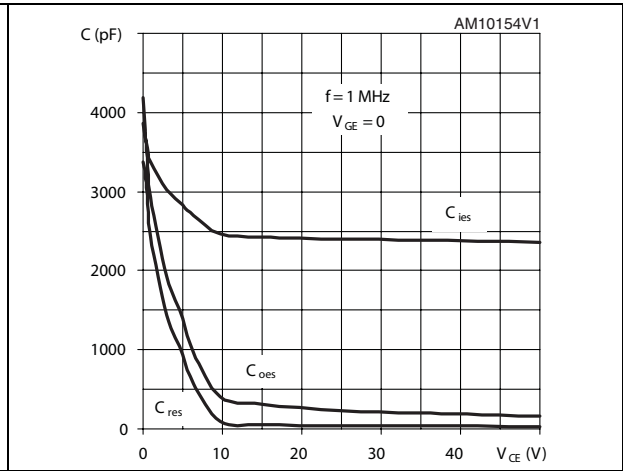

Figure 10. Switching losses vs temperature

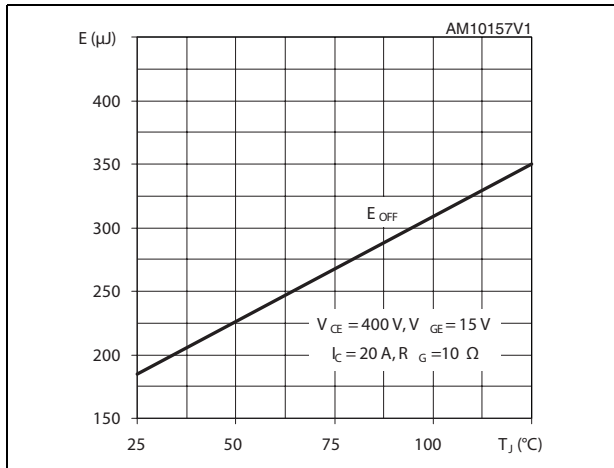

Figure 11. Switching losses vs gate resistance

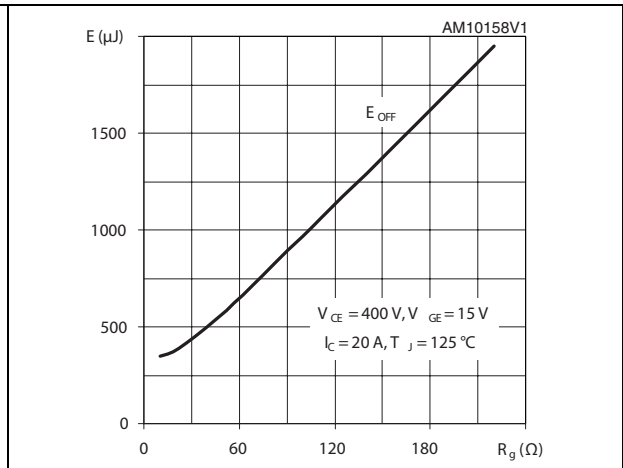

Figure 12. Switching losses vs collector current

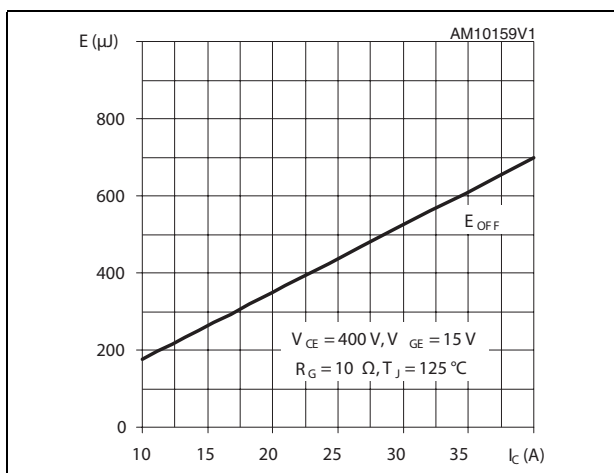

Figure 13. Diode forward on voltage

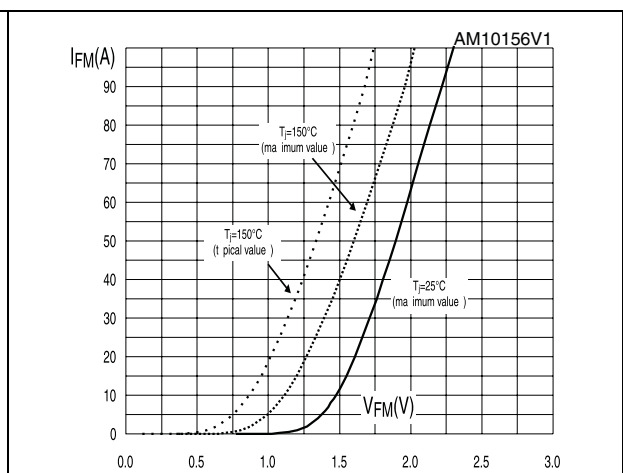

Figure 14. Turn-off SOA

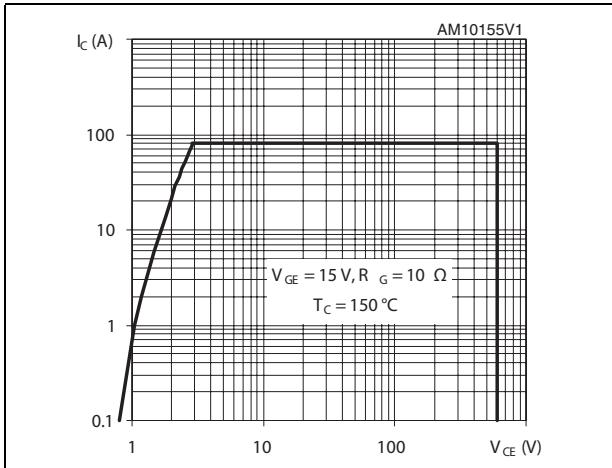
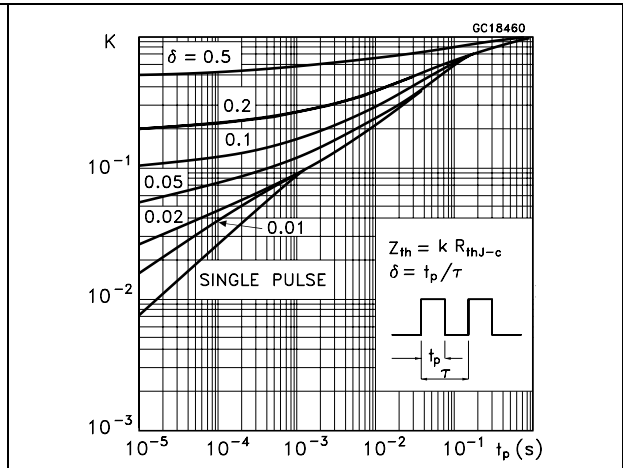

Figure 15. Thermal impedance







## 4 Package mechanical data

In order to meet environmental requirements, ST offers these devices in different grades of ECOPACK<sup>®</sup> packages, depending on their level of environmental compliance. ECOPACK<sup>®</sup> specifications, grade definitions and product status are available at: [www.st.com](http://www.st.com). ECOPACK is an ST trademark.

**Table 9. TO-247 mechanical data**

Dim.	mm		
	Min.	Typ.	Max.
A	4.85		5.15
A1	2.20		2.60
b	1.0		1.40
b1	2.0		2.40
b2	3.0		3.40
c	0.40		0.80
D	19.85		20.15
E	15.45		15.75
e		5.45	
L	14.20		14.80
L1	3.70		4.30
L2		18.50	
ØP	3.55		3.65
ØR	4.50		5.50
S		5.50	

Figure 20. TO-247 drawing

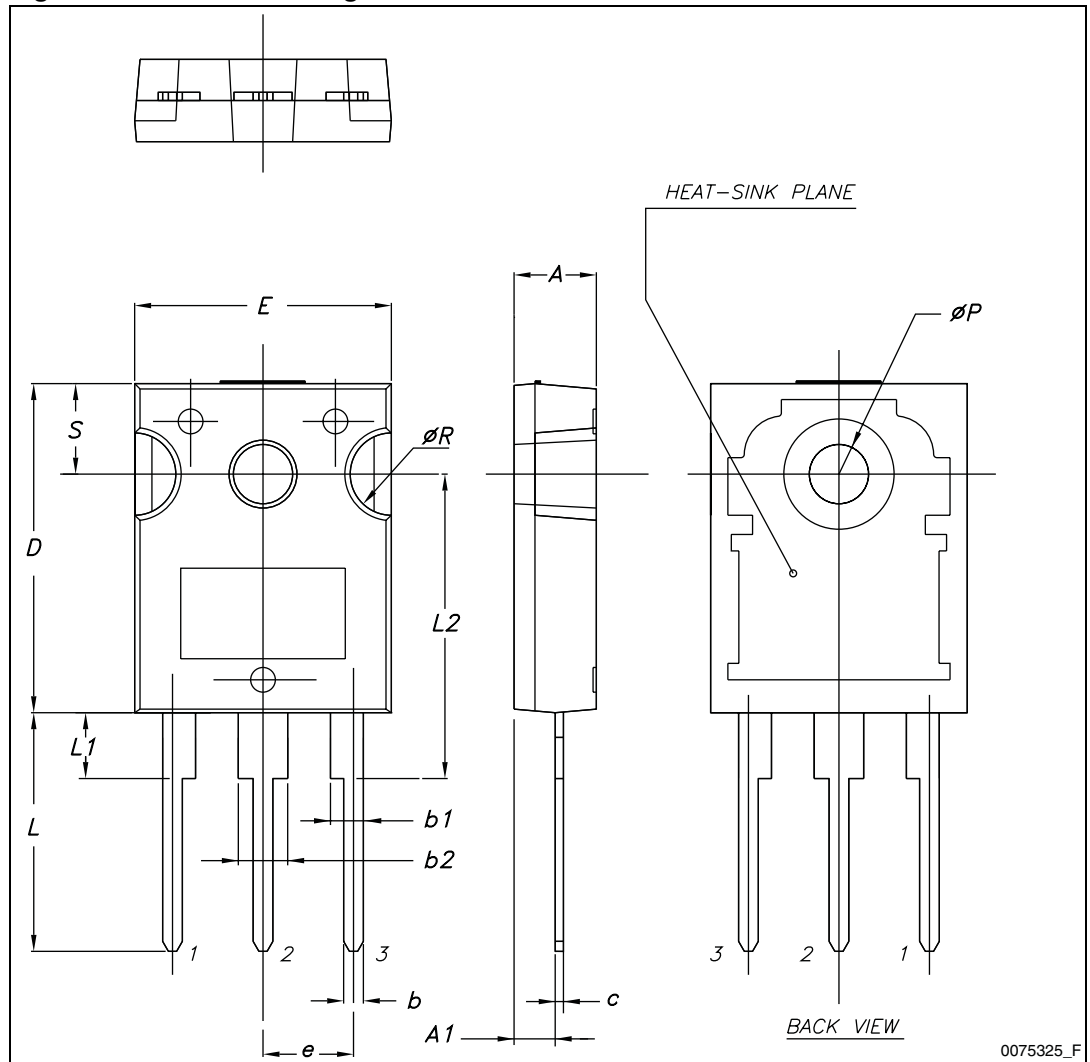
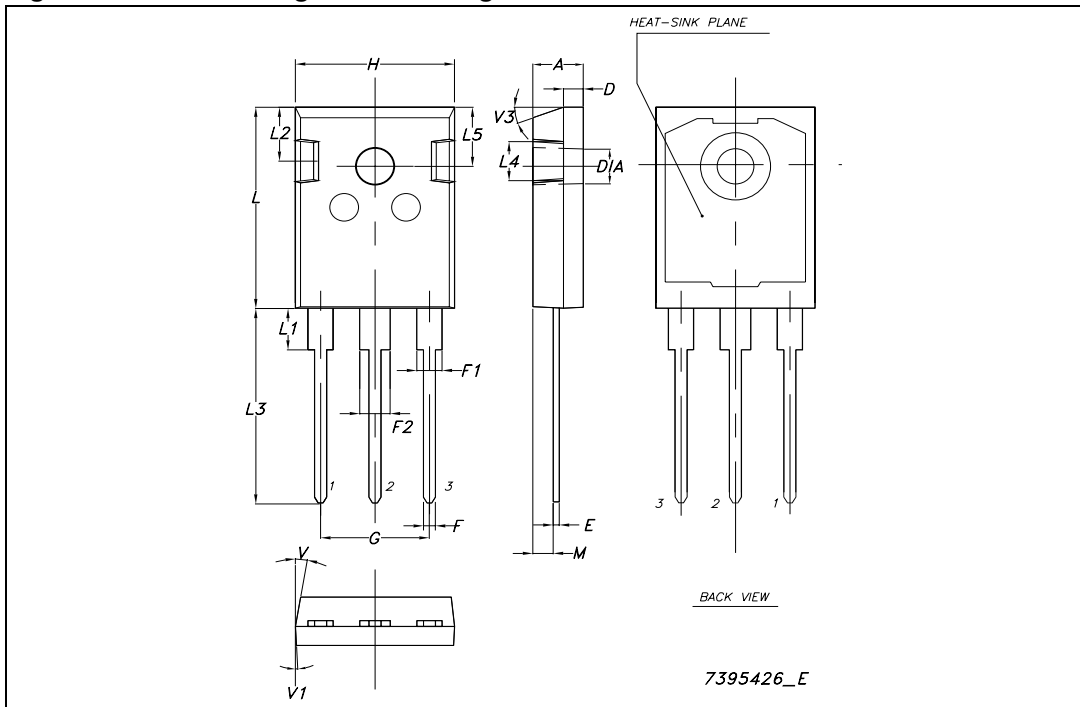

Table 10. TO-247 long leads mechanical data

Dim.	mm		
	Min.	Typ.	Max.
A	4.90		5.15
D	1.85		2.10
E	0.55		0.67
F	1.07		1.32
F1	1.90		2.38
F2	2.87		3.38
G	10.90 BSC		
H	15.77		16.02
L	20.82		21.07
L1	4.16		4.47
L2	5.49		5.74
L3	20.05		20.30
L4	3.68		3.93
L5	6.04		6.29
M	2.27		2.52
V		10°	
V1		3°	
V3		20°	
Dia.	3.55		3.66

Figure 21. TO-247 long leads drawing



## 5 Revision history

Table 11. Document revision history

Date	Revision	Changes
03-Aug-2009	1	Initial release.
02-Sep-2009	2	Minor text changes throughout the document Removed watermark.
25-Aug-2011	3	Inserted new <i>Section 2.1: Electrical characteristics (curves)</i> . Updated <i>Section 4: Package mechanical data</i> . Minor text changes.

**Please Read Carefully:**

Information in this document is provided solely in connection with ST products. STMicroelectronics NV and its subsidiaries ("ST") reserve the right to make changes, corrections, modifications or improvements, to this document, and the products and services described herein at any time, without notice.

All ST products are sold pursuant to ST's terms and conditions of sale.

Purchasers are solely responsible for the choice, selection and use of the ST products and services described herein, and ST assumes no liability whatsoever relating to the choice, selection or use of the ST products and services described herein.

No license, express or implied, by estoppel or otherwise, to any intellectual property rights is granted under this document. If any part of this document refers to any third party products or services it shall not be deemed a license grant by ST for the use of such third party products or services, or any intellectual property contained therein or considered as a warranty covering the use in any manner whatsoever of such third party products or services or any intellectual property contained therein.

**UNLESS OTHERWISE SET FORTH IN ST'S TERMS AND CONDITIONS OF SALE ST DISCLAIMS ANY EXPRESS OR IMPLIED WARRANTY WITH RESPECT TO THE USE AND/OR SALE OF ST PRODUCTS INCLUDING WITHOUT LIMITATION IMPLIED WARRANTIES OF MERCHANTABILITY, FITNESS FOR A PARTICULAR PURPOSE (AND THEIR EQUIVALENTS UNDER THE LAWS OF ANY JURISDICTION), OR INFRINGEMENT OF ANY PATENT, COPYRIGHT OR OTHER INTELLECTUAL PROPERTY RIGHT.**

**UNLESS EXPRESSLY APPROVED IN WRITING BY TWO AUTHORIZED ST REPRESENTATIVES, ST PRODUCTS ARE NOT RECOMMENDED, AUTHORIZED OR WARRANTED FOR USE IN MILITARY, AIR CRAFT, SPACE, LIFE SAVING, OR LIFE SUSTAINING APPLICATIONS, NOR IN PRODUCTS OR SYSTEMS WHERE FAILURE OR MALFUNCTION MAY RESULT IN PERSONAL INJURY, DEATH, OR SEVERE PROPERTY OR ENVIRONMENTAL DAMAGE. ST PRODUCTS WHICH ARE NOT SPECIFIED AS "AUTOMOTIVE GRADE" MAY ONLY BE USED IN AUTOMOTIVE APPLICATIONS AT USER'S OWN RISK.**

Resale of ST products with provisions different from the statements and/or technical features set forth in this document shall immediately void any warranty granted by ST for the ST product or service described herein and shall not create or extend in any manner whatsoever, any liability of ST.

ST and the ST logo are trademarks or registered trademarks of ST in various countries.

Information in this document supersedes and replaces all information previously supplied.

The ST logo is a registered trademark of STMicroelectronics. All other names are the property of their respective owners.

© 2011 STMicroelectronics - All rights reserved

STMicroelectronics group of companies

Australia - Belgium - Brazil - Canada - China - Czech Republic - Finland - France - Germany - Hong Kong - India - Israel - Italy - Japan - Malaysia - Malta - Morocco - Philippines - Singapore - Spain - Sweden - Switzerland - United Kingdom - United States of America

[www.st.com](http://www.st.com)



# Mouser Electronics

Authorized Distributor

Click to View Pricing, Inventory, Delivery & Lifecycle Information:

[STMicroelectronics:](#)

[STGW35HF60WDI](#) [STGWA35HF60WDI](#)