

Standard Rectifier

1~ Rectifier	
V_{RRM}	= 1200 V
I_{DAV}	= 20 A
I_{FSM}	= 150 A

1~ Rectifier Bridge

Part number

FBO16-12N

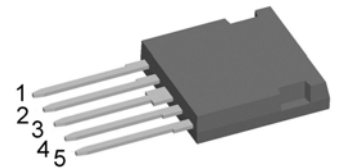

Backside: isolated

 E72873

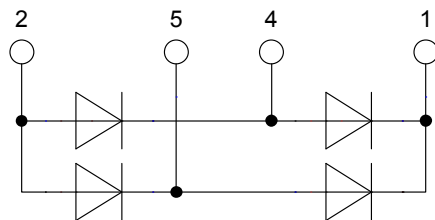

Features / Advantages:

- Planar passivated chips
- Very low leakage current
- Very low forward voltage drop
- Improved thermal behaviour

Applications:

- Diode Bridge for main rectification

Package: i4-Pac

- Isolation Voltage: 3000V~
- Industry convenient outline
- RoHS compliant
- Epoxy meets UL 94V-0
- Soldering pins for PCB mounting
- Backside: DCB ceramic
- Reduced weight
- Advanced power cycling

Rectifier				Ratings				
Symbol	Definition	Conditions		min.	typ.	max.	Unit	
V_{RSM}	max. non-repetitive reverse blocking voltage					1300	V	
V_{RRM}	max. repetitive reverse blocking voltage					1200	V	
I_R	reverse current, drain current	$V_R = 1200\text{ V}$	$T_{VJ} = 25^\circ\text{C}$			10	μA	
		$V_R = 1200\text{ V}$	$T_{VJ} = 150^\circ\text{C}$			1	mA	
V_F	forward voltage drop	$I_F = 10\text{ A}$	$T_{VJ} = 25^\circ\text{C}$			1.21	V	
						1.43	V	
		$I_F = 20\text{ A}$	$T_{VJ} = 150^\circ\text{C}$			1.14	V	
						1.45	V	
I_{DAV}	bridge output current	$T_C = 130^\circ\text{C}$ rectangular	$T_{VJ} = 175^\circ\text{C}$			20	A	
								d = 0.5
V_{FO}	threshold voltage					0.81	V	
r_F	slope resistance					32	m Ω	
		} for power loss calculation only						
R_{thJC}	thermal resistance junction to case					3	K/W	
R_{thCH}	thermal resistance case to heatsink				0.20		K/W	
P_{tot}	total power dissipation			$T_C = 25^\circ\text{C}$		50	W	
I_{FSM}	max. forward surge current	t = 10 ms; (50 Hz), sine	$T_{VJ} = 45^\circ\text{C}$			150	A	
								t = 8,3 ms; (60 Hz), sine
		t = 10 ms; (50 Hz), sine	$T_{VJ} = 150^\circ\text{C}$				130	A
I^2t	value for fusing	t = 10 ms; (50 Hz), sine	$T_{VJ} = 45^\circ\text{C}$			115	A ² s	
								t = 8,3 ms; (60 Hz), sine
		t = 10 ms; (50 Hz), sine	$T_{VJ} = 150^\circ\text{C}$				85	A ² s
C_J	junction capacitance	$V_R = 400\text{ V}; f = 1\text{ MHz}$	$T_{VJ} = 25^\circ\text{C}$			4	pF	

Package i4-Pac				Ratings		
Symbol	Definition	Conditions	min.	typ.	max.	Unit
I_{RMS}	RMS current	per terminal			35	A
T_{stg}	storage temperature		-55		150	°C
T_{VJ}	virtual junction temperature		-55		175	°C
Weight				9		g
F_C	mounting force with clip		20		120	N
$d_{Spp/App}$	creepage distance on surface striking distance through air	terminal to terminal	1.7			mm
$d_{Spb/Apb}$		terminal to backside	5.1			mm
V_{ISOL}	isolation voltage	t = 1 second	3000			V
		t = 1 minute	2500			V

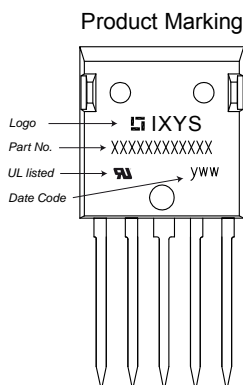

Ordering	Part Number	Marking on Product	Delivery Mode	Quantity	Code No.
Standard	FBO16-12N	FBO16-12N	Tube	25	492310

Equivalent Circuits for Simulation

* on die level

$T_{VJ} = 175^{\circ}C$



Rectifier

$V_{0\ max}$	threshold voltage	0.81	V
$R_{0\ max}$	slope resistance *	29	mΩ

Outlines i4-Pac

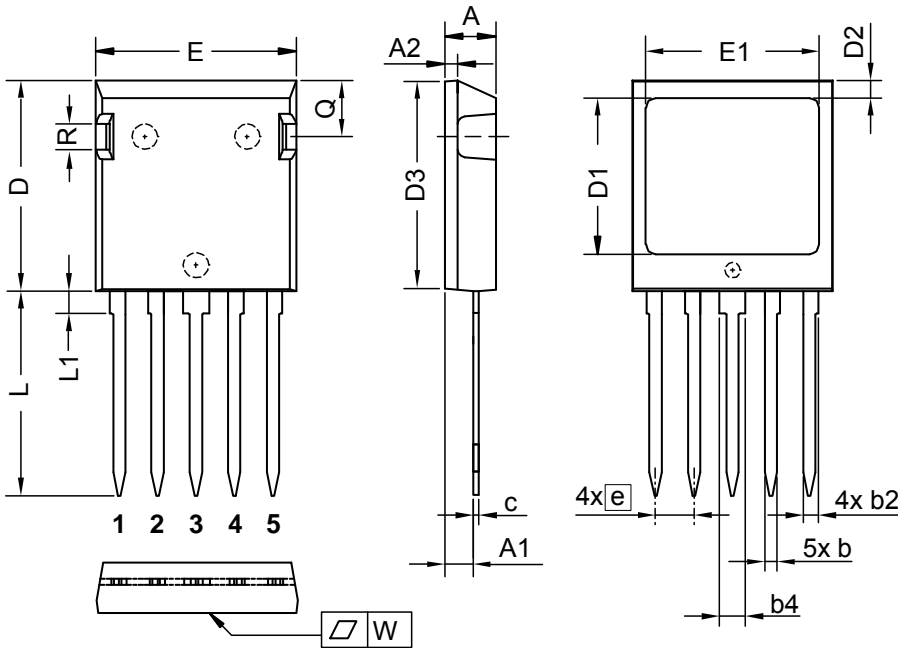

Dim.	Millimeter		Inches	
	min	max	min	max
A	4.83	5.21	0.190	0.205
A1	2.59	3.00	0.102	0.118
A2	1.17	2.16	0.046	0.085
b	1.14	1.40	0.045	0.055
b2	1.47	1.73	0.058	0.068
b4	2.54	2.79	0.100	0.110
c	0.51	0.74	0.020	0.029
D	20.80	21.34	0.819	0.840
D1	14.99	15.75	0.590	0.620
D2	1.65	2.03	0.065	0.080
D3	20.30	20.70	0.799	0.815
E	19.56	20.29	0.770	0.799
E1	16.76	17.53	0.660	0.690
e	3.81 BSC		0.150 BSC	
L	19.81	21.34	0.780	0.840
L1	2.11	2.59	0.083	0.102
Q	5.33	6.20	0.210	0.244
R	2.54	4.57	0.100	0.180
W	-	0.10	-	0.004

Die konvexe Form des Substrates ist typ. < 0.05 mm über der Kunststoffoberfläche der Bauteilunterseite
 The convexbow of substrate is typ. < 0.05 mm over plastic surface level of device bottom side

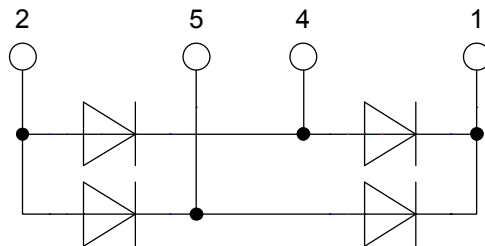

Rectifier

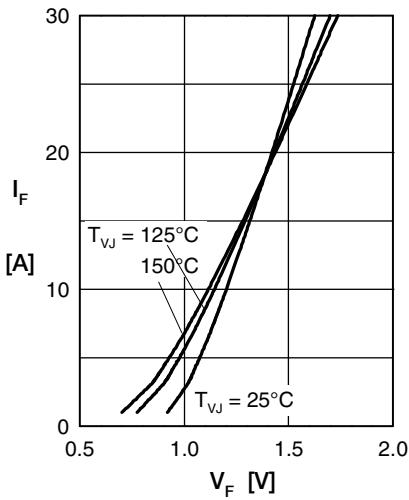

Fig. 1 Forward current versus voltage drop per diode

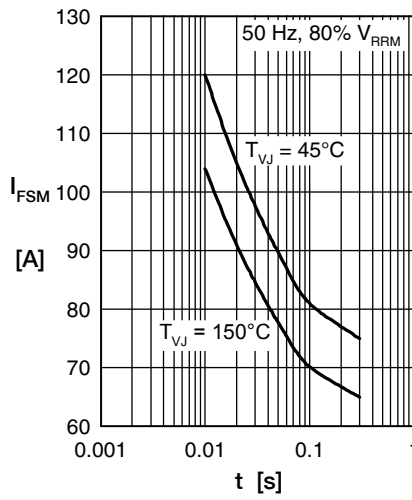

Fig. 2 Surge overload current

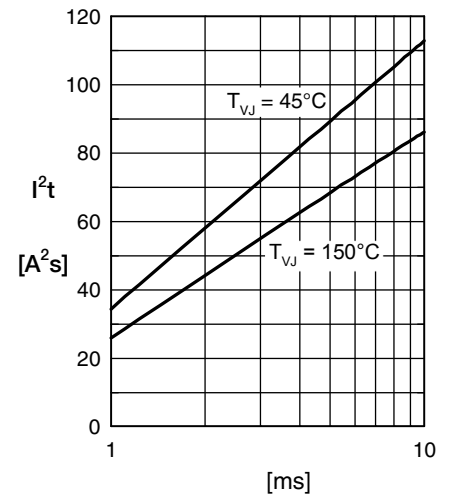

Fig. 3 I^2t versus time per diode

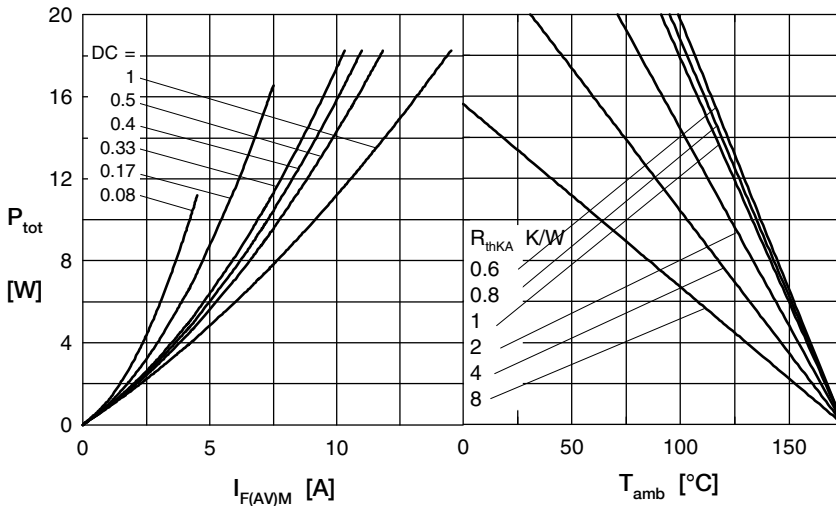

Fig. 4 Power dissipation vs. direct output current & ambient temperature

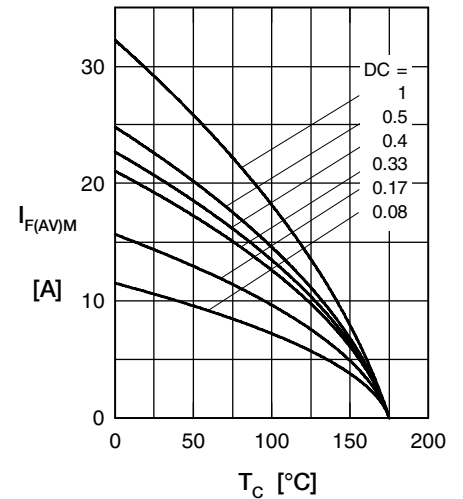

Fig. 5 Max. forward current vs. case temperature

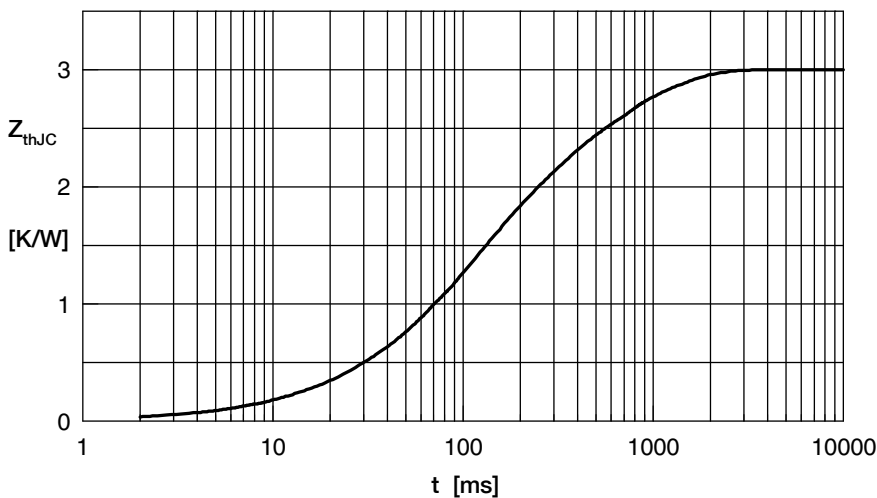

Fig. 6 Transient thermal impedance junction to case

Constants for Z_{thJC} calculation:

i	R_{thi} (K/W)	t_i (s)
1	1.359	0.1015
2	0.3286	0.1026
3	0.4651	0.4919
4	0.8473	0.62

Mouser Electronics

Authorized Distributor

Click to View Pricing, Inventory, Delivery & Lifecycle Information:

[IXYS:](#)

[FBO16-12N](#)