

High Efficiency Standard Rectifier

$$V_{RRM} = 1200V$$

$$I_{FAV} = 60A$$

$$V_F = 1.1V$$

Single Diode

Part number

DLA60I1200HA

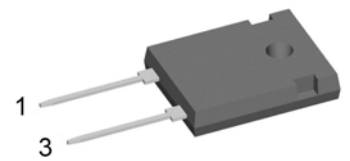

Backside: cathode

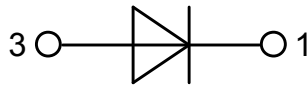

Features / Advantages:

- Planar passivated chips
- Very low leakage current
- Very low forward voltage drop
- Improved thermal behaviour

Applications:

- Diode for main rectification
- For single and three phase bridge configurations

Package: TO-247

- Industry standard outline
- RoHS compliant
- Epoxy meets UL 94V-0

Rectifier				Ratings			
Symbol	Definition	Conditions		min.	typ.	max.	Unit
V_{RSM}	max. non-repetitive reverse blocking voltage					1300	V
V_{RRM}	max. repetitive reverse blocking voltage					1200	V
I_R	reverse current, drain current	$V_R = 1200$ V	$T_{VJ} = 25^\circ\text{C}$			30	μA
		$V_R = 1200$ V	$T_{VJ} = 150^\circ\text{C}$			0.3	mA
V_F	forward voltage drop	$I_F = 60$ A	$T_{VJ} = 25^\circ\text{C}$			1.19	V
						1.42	V
		$I_F = 120$ A	$T_{VJ} = 150^\circ\text{C}$			1.10	V
						1.41	V
I_{FAV}	average forward current	$T_C = 150^\circ\text{C}$ rectangular $d = 0.5$	$T_{VJ} = 175^\circ\text{C}$			60	A
V_{FO}	threshold voltage					0.78	V
r_F	slope resistance					5.1	m Ω
R_{thJC}	thermal resistance junction to case					0.3	K/W
R_{thCH}	thermal resistance case to heatsink				0.25		K/W
P_{tot}	total power dissipation			$T_C = 25^\circ\text{C}$		500	W
I_{FSM}	max. forward surge current	$t = 10$ ms; (50 Hz), sine	$T_{VJ} = 45^\circ\text{C}$			850	A
						920	A
		$t = 8,3$ ms; (60 Hz), sine	$V_R = 0$ V			725	A
						780	A
I^2t	value for fusing	$t = 10$ ms; (50 Hz), sine	$T_{VJ} = 45^\circ\text{C}$			3.62	kA ² s
						3.52	kA ² s
		$t = 8,3$ ms; (60 Hz), sine	$V_R = 0$ V			2.63	kA ² s
						2.53	kA ² s
C_J	junction capacitance	$V_R = 400$ V $f = 1$ MHz	$T_{VJ} = 25^\circ\text{C}$		33		pF

Package TO-247			Ratings			
Symbol	Definition	Conditions	min.	typ.	max.	Unit
I_{RMS}	RMS current	per terminal			70	A
T_{stg}	storage temperature		-55		150	°C
T_{VJ}	virtual junction temperature		-55		175	°C
Weight				6		g
M_D	mounting torque		0.8		1.2	Nm
F_C	mounting force with clip		20		120	N

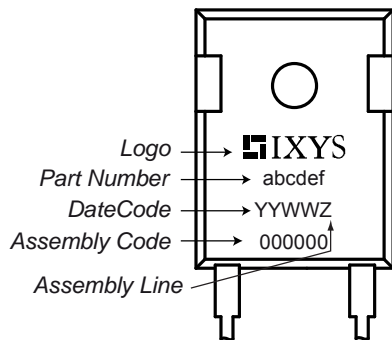
Product Marking

Part number

D = Diode
 L = High Efficiency Standard Rectifier
 A = (up to 1200V)
 60 = Current Rating [A]
 I = Single Diode
 1200 = Reverse Voltage [V]
 HA = TO-247AD (2)

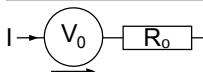
Ordering	Part Number	Marking on Product	Delivery Mode	Quantity	Code No.
Standard	DLA60I1200HA	DLA60I1200HA	Tube	30	508170

Equivalent Circuits for Simulation
** on die level*
 $T_{VJ} = 175^{\circ}\text{C}$

Rectifier

$V_{0\max}$	threshold voltage	0.78	V
$R_{0\max}$	slope resistance *	2.5	mΩ

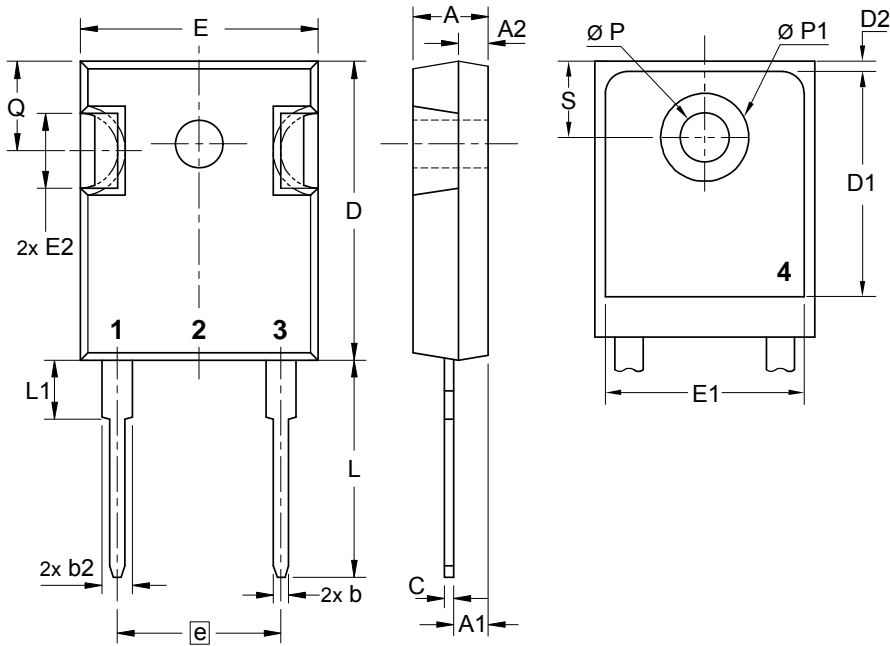
Outlines TO-247



Sym.	Inches		Millimeter	
	min.	max.	min.	max.
A	0.185	0.209	4.70	5.30
A1	0.087	0.102	2.21	2.59
A2	0.059	0.098	1.50	2.49
D	0.819	0.845	20.79	21.45
E	0.610	0.640	15.48	16.24
E2	0.170	0.216	4.31	5.48
e	0.430 BSC		10.92 BSC	
L	0.780	0.800	19.80	20.30
L1	-	0.177	-	4.49
Ø P	0.140	0.144	3.55	3.65
Q	0.212	0.244	5.38	6.19
S	0.242 BSC		6.14 BSC	
b	0.039	0.055	0.99	1.40
b2	0.065	0.094	1.65	2.39
b4	0.102	0.135	2.59	3.43
c	0.015	0.035	0.38	0.89
D1	0.515	-	13.07	-
D2	0.020	0.053	0.51	1.35
E1	0.530	-	13.45	-
Ø P1	-	0.29	-	7.39



Rectifier

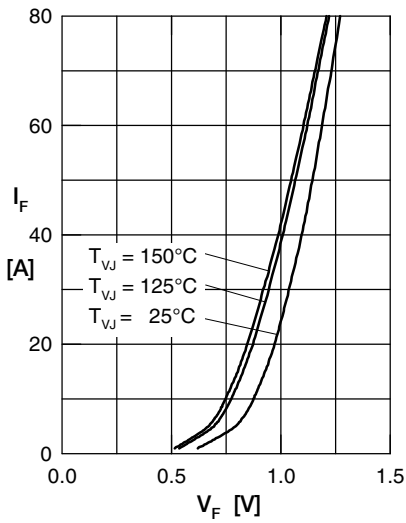

Fig. 1 Forward current versus voltage drop per diode

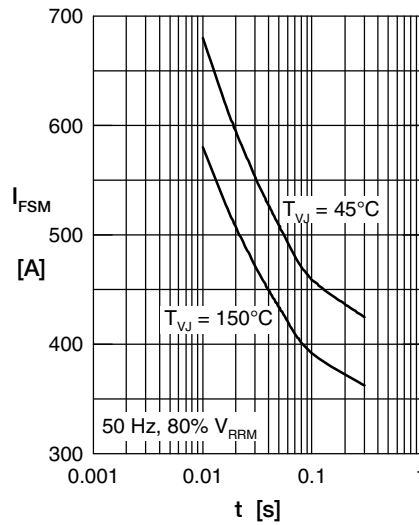

Fig. 2 Surge overload current

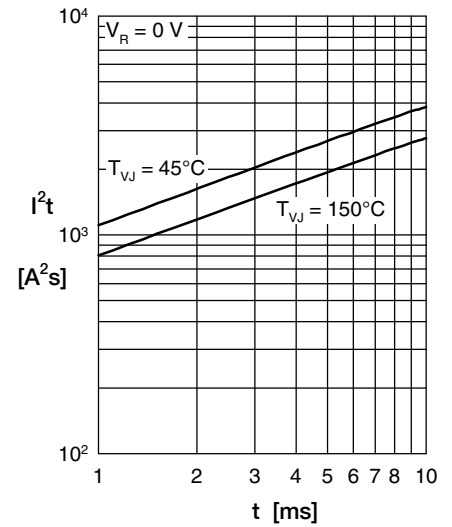

Fig. 3 I^2t versus time per diode

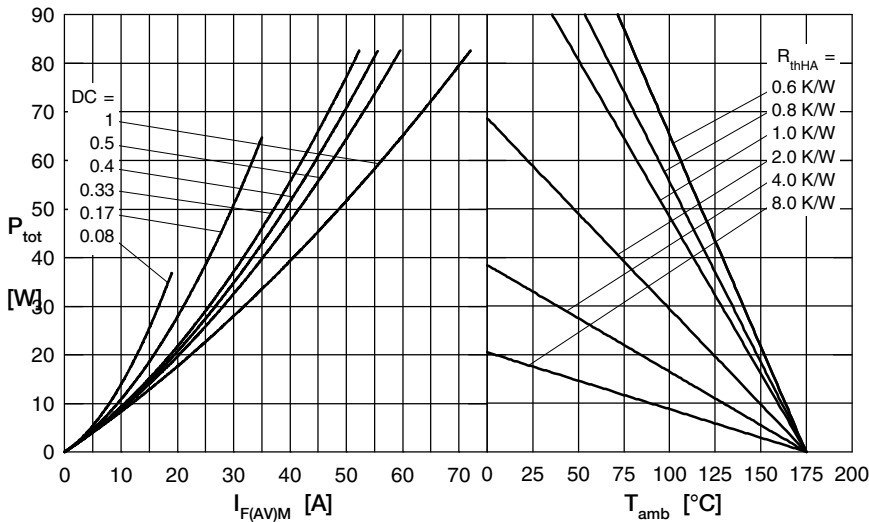

Fig. 4 Power dissipation vs. direct output current and ambient temperature

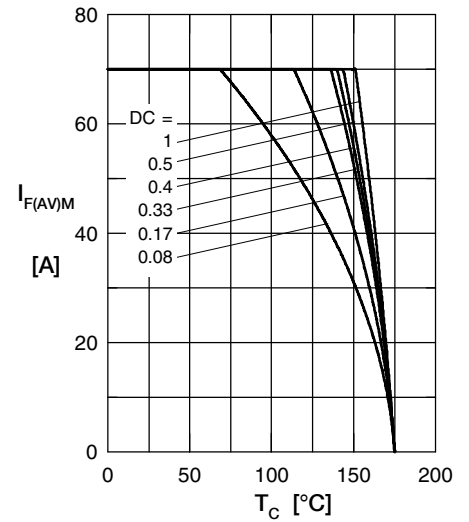

Fig. 5 Max. forward current vs. case temperature

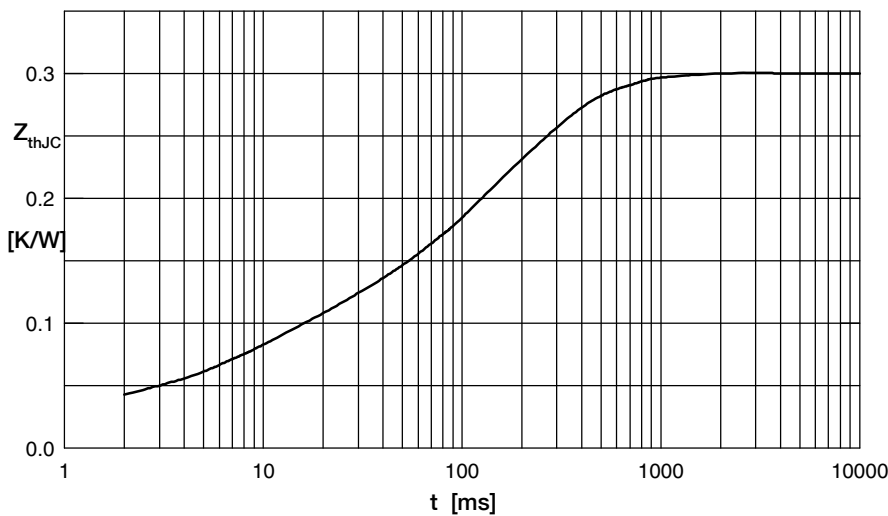

Fig. 6 Transient thermal impedance junction to case

Constants for Z_{thJC} calculation:

i	R_{thi} (K/W)	t_i (s)
1	0.044	0.007
2	0.027	0.0001
3	0.029	0.02
4	0.05	0.37
5	0.15	0.15

Mouser Electronics

Authorized Distributor

Click to View Pricing, Inventory, Delivery & Lifecycle Information:

[IXYS:](#)

[DLA60I1200HA](#)