

PART  
NAME

JUNCTION BOX

PART  
No.

JB-3960

REVISION  
DATE

7-18-11

MATERIAL - 16 GA. [1.5mm] STEEL  
FINISH - SMOOTH GRAY POWDERCOAT

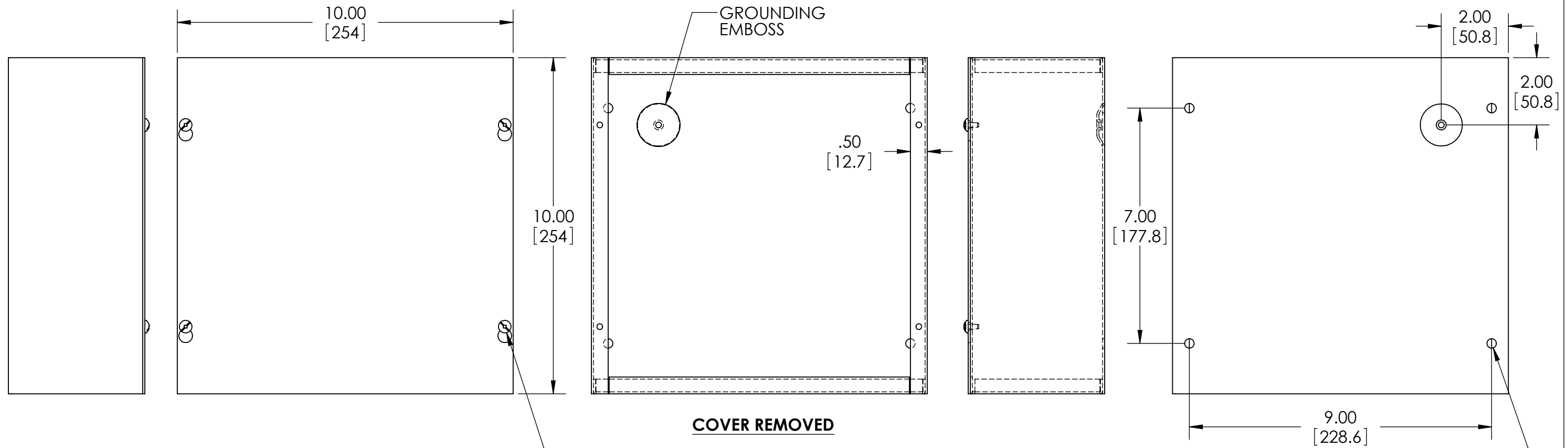
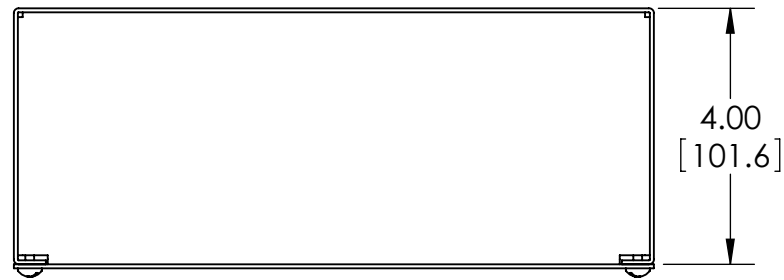
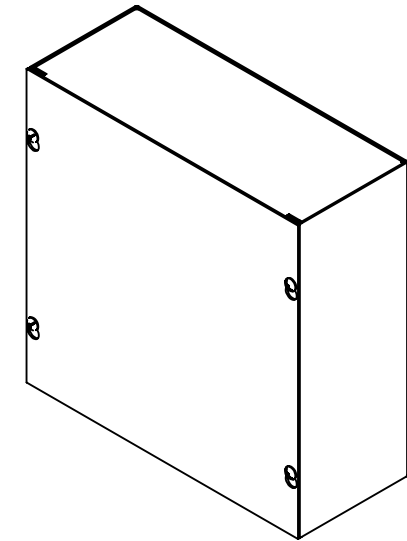

SCREWS: #10-32 x .31"[8mm] LG.  
MACHINE, PAN HEAD, SLOTTED/SQUARE  
COMBINATION STYLE DRIVE, STEEL, ZINC PLATED.  
(SUPPLIED FOR COVER MOUNTING AND  
FOR GROUND POINT).

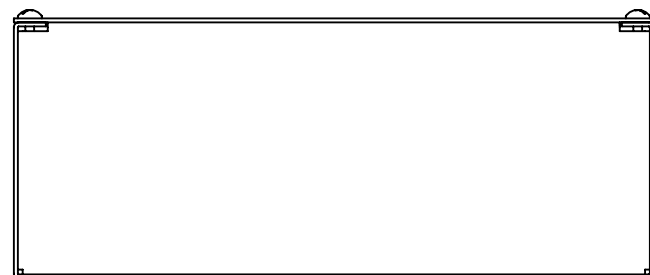

# Mouser Electronics

Authorized Distributor

Click to View Pricing, Inventory, Delivery & Lifecycle Information:

[Bud Industries:](#)

[JB-3960](#) [JB-3960-KO](#)