

## Product Summary

BV <sub>DSS</sub>	Max R <sub>DS(ON)</sub>	Package	Max I <sub>D</sub> T <sub>A</sub> = +25°C
-100V	1Ω @ V <sub>GS</sub> = -10V	SOT23	-0.7A
	1.45Ω @ V <sub>GS</sub> = -6.0V		-0.5A

## Description

This MOSFET utilizes a unique structure that combines the benefits of low on-resistance with fast switching speed, making it ideal for high-efficiency power management applications.

## Applications

- DC-DC Converters
- Power Management Functions
- Disconnect Switches
- Motor Control



Top View

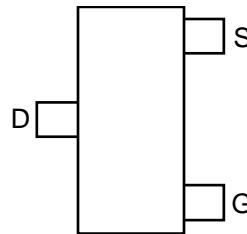

Top View  
Pin Out

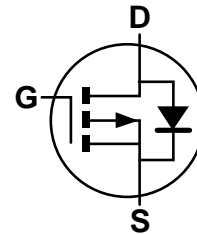

Equivalent Circuit

## Features

- Fast Switching Speed
- Low Input Capacitance
- Low Gate Charge
- Low Threshold
- **Totally Lead-Free & Fully RoHS Compliant (Notes 1 & 2)**
- **Halogen and Antimony Free. "Green" Device (Note 3)**
- **Qualified to AEC-Q101 Standards for High Reliability**
- **An Automotive-Compliant Part is Available Under Separate Data Sheet ([ZXMP10A13FQ](#))**

## Mechanical Data

- Case: SOT23
- Case Material: Molded Plastic, UL Flammability Classification Rating 94V-0
- Moisture Sensitivity: Level 1 per J-STD-020
- Terminals: Matte Tin Finish Annealed over Copper Leadframe Solderable per MIL-STD-202, Method 208 (E3)
- Weight: 0.009 grams (Approximate)

## Ordering Information (Note 4)

Part Number	Case	Packaging
ZXMP10A13FTA	SOT23	3,000/Tape & Reel
ZXMP10A13FTC	SOT23	10,000/Tape & Reel

- Notes:
1. No purposely added lead. Fully EU Directive 2002/95/EC (RoHS) & 2011/65/EU (RoHS 2) compliant.
  2. See [http://www.diodes.com/quality/lead\\_free.html](http://www.diodes.com/quality/lead_free.html) for more information about Diodes Incorporated's definitions of Halogen- and Antimony-free, "Green" and Lead-free.
  3. Halogen- and Antimony-free "Green" products are defined as those which contain <900ppm bromine, <900ppm chlorine (<1500ppm total Br + Cl) and <1000ppm antimony compounds.
  4. For packaging details, go to our website at <http://www.diodes.com/products/packages.html>.

## Marking Information

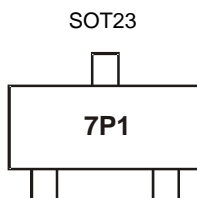

7P1 = Product Type Marking Code

**Maximum Ratings** (@ $T_A = +25^\circ\text{C}$ , unless otherwise specified.)

Characteristic			Symbol	Value	Units
Drain-Source Voltage			$V_{DSS}$	-100	V
Gate-Source Voltage			$V_{GS}$	$\pm 20$	V
Continuous Drain Current	$V_{GS} = 10\text{V}$	$T_A = +70^\circ\text{C}$ (Note 6)	$I_D$	-0.7	A
		(Note 6)		-0.5	
		(Note 6)		-0.6	
Pulsed Drain Current (Note 7)			$I_{DM}$	-3.1	A
Continuous Source Current (Body Diode) (Note 5)			$I_S$	-1.1	A
Pulsed Source Current (Body Diode) (Note 7)			$I_{SM}$	-3.1	A

**Thermal Characteristics**

Characteristic		Symbol	Value	Unit
Power Dissipation (Note 5)		$P_D$	625	mW
Linear Derating Factor			5	mW/ $^\circ\text{C}$
Power Dissipation (Note 6)		$P_D$	806	mW
Linear Derating Factor			6.4	mW/ $^\circ\text{C}$
Thermal Resistance, Junction to Ambient (Note 5)		$R_{\theta JA}$	200	$^\circ\text{C/W}$
Thermal Resistance, Junction to Ambient (Note 6)		$R_{\theta JA}$	155	$^\circ\text{C/W}$
Thermal Resistance, Junction to Leads (Note 8)		$R_{\theta JL}$	194	$^\circ\text{C/W}$
Operating and Storage Temperature Range		$T_J, T_{STG}$	-55 to +150	$^\circ\text{C}$

- Notes:
5. For a device surface mounted on 25mm x 25mm FR4 PCB with high coverage of single sided 1oz copper, in still air conditions.
  6. For a device surface mounted on FR4 PCB measured at  $t \leq 5$  secs.
  7. Repetitive rating 25mm x 25mm FR4 PCB,  $D=0.05$  pulse width=10 $\mu\text{s}$  - pulse current limited by maximum junction temperature.
  8. Thermal resistance from junction to solder-point (at the end of the drain lead).

**Thermal Characteristics (Continued)**

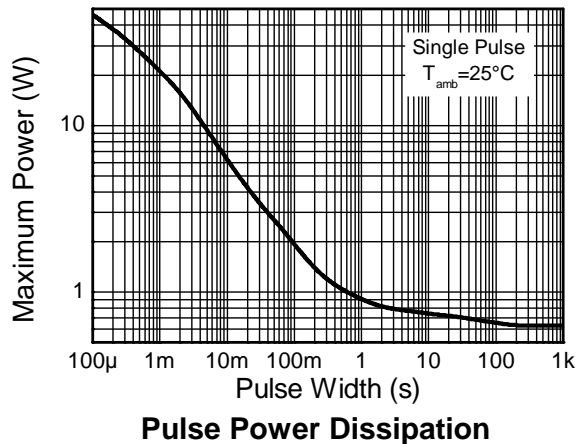
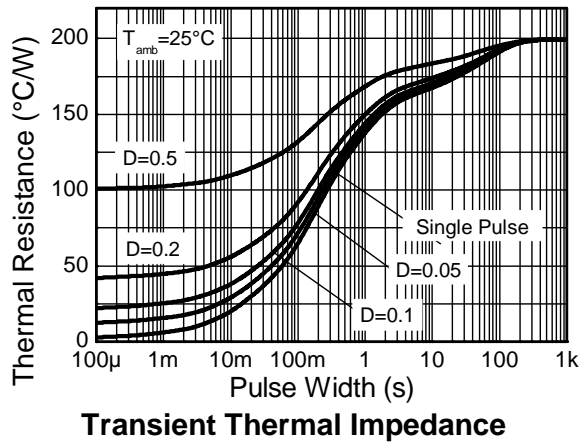
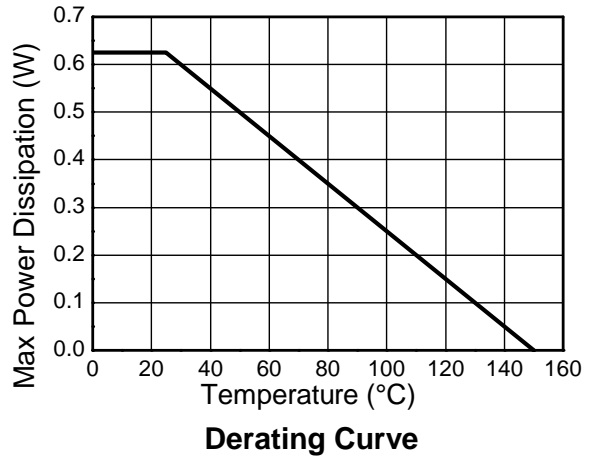
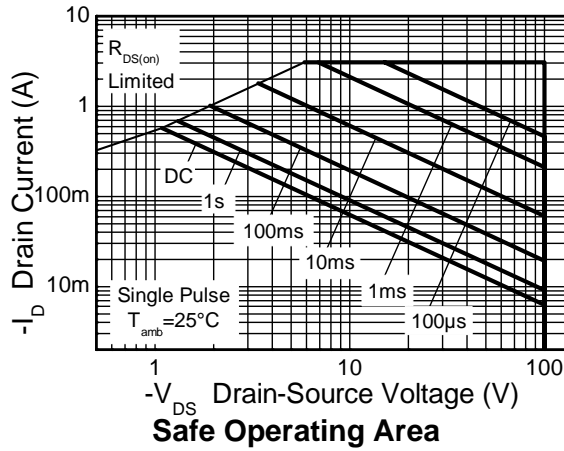

**Electrical Characteristics** (@T<sub>A</sub> = +25°C, unless otherwise specified.)

Characteristic	Symbol	Min	Typ	Max	Unit	Test Condition
<b>OFF CHARACTERISTICS</b>						
Drain-Source Breakdown Voltage	BV <sub>DSS</sub>	-100	—	—	V	I <sub>D</sub> = -250μA, V <sub>GS</sub> = 0V
Zero Gate Voltage Drain Current	I <sub>DSS</sub>	—	—	-1.0	μA	V <sub>DS</sub> = -100V, V <sub>GS</sub> = 0V
Gate-Source Leakage	I <sub>GSS</sub>	—	—	±100	nA	V <sub>GS</sub> = ±20V, V <sub>DS</sub> = 0V
<b>ON CHARACTERISTICS</b>						
Gate Threshold Voltage	V <sub>GS(TH)</sub>	-2.0	—	-4.0	V	I <sub>D</sub> = -250μA, V <sub>DS</sub> = V <sub>GS</sub>
Static Drain-Source On-Resistance (Note 9)	R <sub>DS(ON)</sub>	—	—	1.0	Ω	V <sub>GS</sub> = -10V, I <sub>D</sub> = -0.6A
				1.45		V <sub>GS</sub> = -6.0V, I <sub>D</sub> = -0.5A
Forward Transconductance (Notes 9 & 11)	g <sub>FS</sub>	—	1.2	—	S	V <sub>DS</sub> = -15V, I <sub>D</sub> = -0.6A
Diode Forward Voltage (Note 9)	V <sub>SD</sub>	—	-0.85	-0.95	V	T <sub>J</sub> = +25°C, I <sub>S</sub> = -0.75A, V <sub>GS</sub> = 0V
Reverse Recovery Time (Note 11)	t <sub>RR</sub>	—	29	—	ns	T <sub>J</sub> = +25°C, I <sub>F</sub> = -0.9A, di/dt = 100A/μs
Reverse Recovery Charge (Note 11)	Q <sub>RR</sub>	—	31	—	nC	
<b>DYNAMIC CHARACTERISTICS (Note 11)</b>						
Input Capacitance	C <sub>ISS</sub>	—	141	—	pF	V <sub>DS</sub> = -50V, V <sub>GS</sub> = 0V f = 1.0MHz
Output Capacitance	C <sub>OSS</sub>	—	13.1	—		
Reverse Transfer Capacitance	C <sub>RSS</sub>	—	10.8	—		
Turn-On Delay Time (Note 10)	t <sub>D(ON)</sub>	—	1.6	—	ns	V <sub>DD</sub> = -50V, I <sub>D</sub> = -1.0A, R <sub>G</sub> ≅ 6.0Ω, V <sub>GS</sub> = -10V
Turn-On Rise Time (Note 10)	t <sub>R</sub>	—	2.1	—		
Turn-Off Delay Time (Note 10)	t <sub>D(OFF)</sub>	—	5.9	—		
Turn-Off Fall Time (Note 10)	t <sub>F</sub>	—	3.3	—		
Total Gate Charge (Note 10)	Q <sub>G</sub>	—	1.8	—	nC	V <sub>DS</sub> = -50V, V <sub>GS</sub> = -5.0V, I <sub>D</sub> = -0.6A
Total Gate Charge (Note 10)	Q <sub>G</sub>	—	3.5	—	nC	V <sub>DS</sub> = -50V, V <sub>GS</sub> = -10V, I <sub>D</sub> = -0.6A
Gate-Source Charge (Note 10)	Q <sub>GS</sub>	—	0.6	—		
Gate-Drain Charge (Note 10)	Q <sub>GD</sub>	—	1.6	—		

- Notes: 9. Measured under pulsed conditions. Pulse width = 300μs. Duty cycle ≤ 2%.  
10. Switching characteristics are independent of operating junction temperature.  
11. For design aid only, not subject to production testing.

**Typical Characteristics**

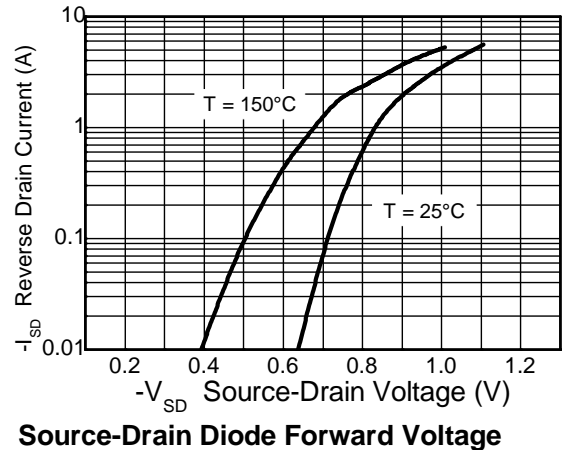
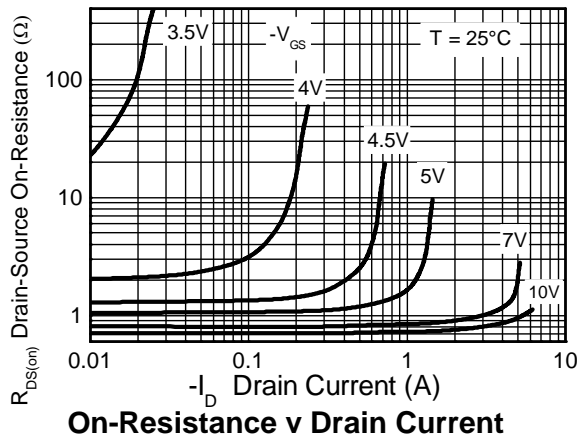
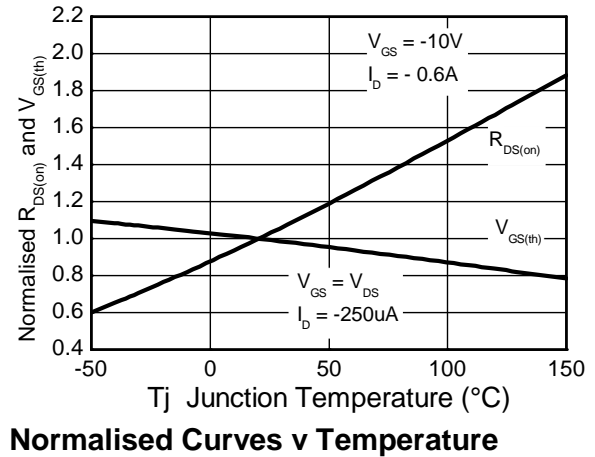
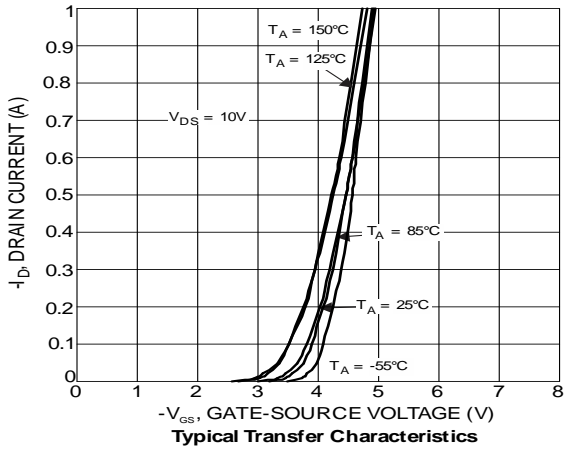
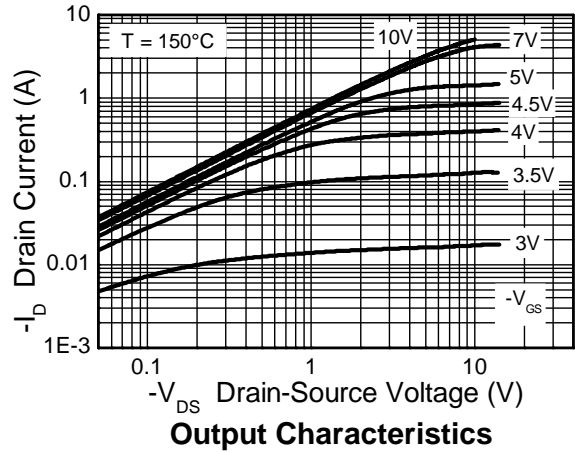
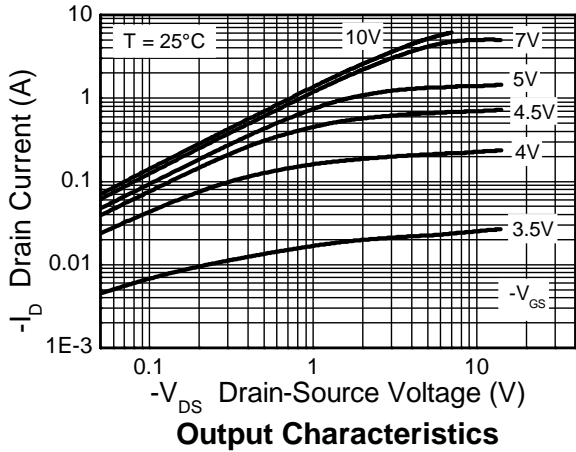

**Typical Characteristics** (Continued)

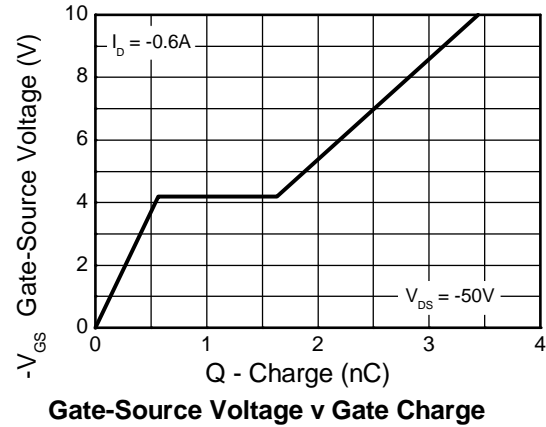
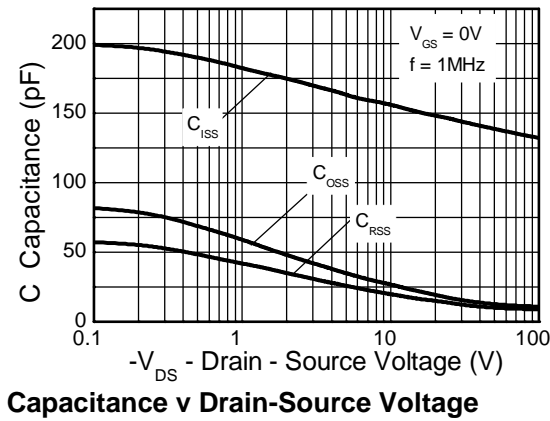

**Test Circuits**

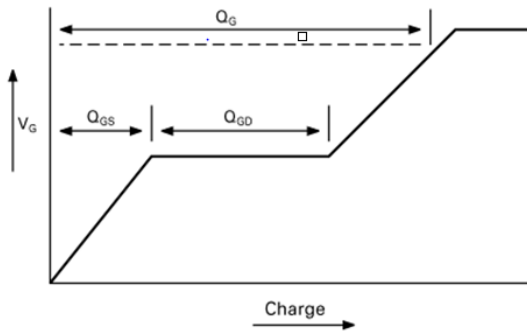

**Basic gate charge waveform**

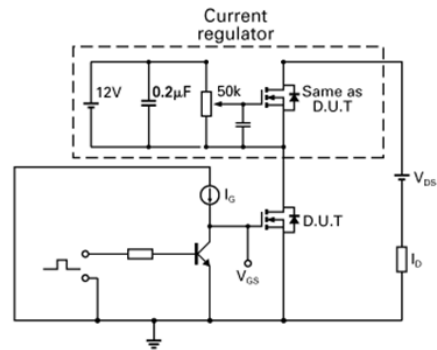

**Gate charge test circuit**

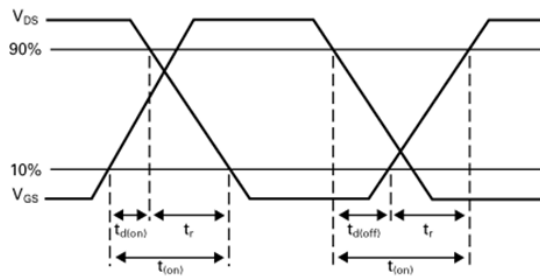

**Switching time waveforms**

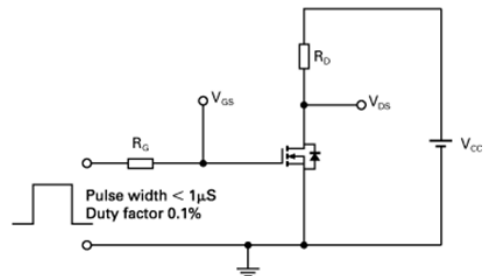

**Switching time test circuit**

**Package Outline Dimensions**

Please see <http://www.diodes.com/package-outlines.html> for the latest version.

**SOT23**

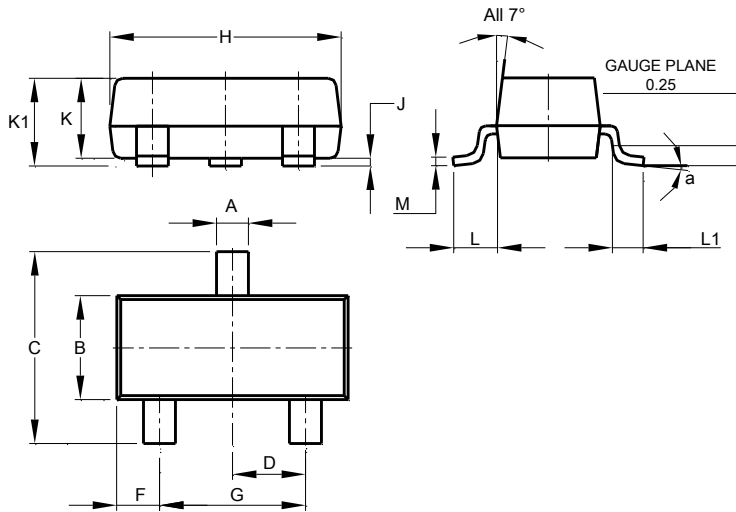

SOT23			
Dim	Min	Max	Typ
A	0.37	0.51	0.40
B	1.20	1.40	1.30
C	2.30	2.50	2.40
D	0.89	1.03	0.915
F	0.45	0.60	0.535
G	1.78	2.05	1.83
H	2.80	3.00	2.90
J	0.013	0.10	0.05
K	0.890	1.00	0.975
K1	0.903	1.10	1.025
L	0.45	0.61	0.55
L1	0.25	0.55	0.40
M	0.085	0.150	0.110
a	0°	8°	—
All Dimensions in mm			

**Suggested Pad Layout**

Please see <http://www.diodes.com/package-outlines.html> for the latest version.

**SOT23**

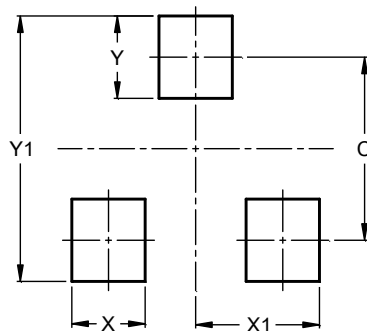

Dimensions	Value (in mm)
C	2.0
X	0.8
X1	1.35
Y	0.9
Y1	2.9

**IMPORTANT NOTICE**

DIODES INCORPORATED MAKES NO WARRANTY OF ANY KIND, EXPRESS OR IMPLIED, WITH REGARDS TO THIS DOCUMENT, INCLUDING, BUT NOT LIMITED TO, THE IMPLIED WARRANTIES OF MERCHANTABILITY AND FITNESS FOR A PARTICULAR PURPOSE (AND THEIR EQUIVALENTS UNDER THE LAWS OF ANY JURISDICTION).

Diodes Incorporated and its subsidiaries reserve the right to make modifications, enhancements, improvements, corrections or other changes without further notice to this document and any product described herein. Diodes Incorporated does not assume any liability arising out of the application or use of this document or any product described herein; neither does Diodes Incorporated convey any license under its patent or trademark rights, nor the rights of others. Any Customer or user of this document or products described herein in such applications shall assume all risks of such use and will agree to hold Diodes Incorporated and all the companies whose products are represented on Diodes Incorporated website, harmless against all damages.

Diodes Incorporated does not warrant or accept any liability whatsoever in respect of any products purchased through unauthorized sales channel. Should Customers purchase or use Diodes Incorporated products for any unintended or unauthorized application, Customers shall indemnify and hold Diodes Incorporated and its representatives harmless against all claims, damages, expenses, and attorney fees arising out of, directly or indirectly, any claim of personal injury or death associated with such unintended or unauthorized application.

Products described herein may be covered by one or more United States, international or foreign patents pending. Product names and markings noted herein may also be covered by one or more United States, international or foreign trademarks.

This document is written in English but may be translated into multiple languages for reference. Only the English version of this document is the final and determinative format released by Diodes Incorporated.

**LIFE SUPPORT**

Diodes Incorporated products are specifically not authorized for use as critical components in life support devices or systems without the express written approval of the Chief Executive Officer of Diodes Incorporated. As used herein:

A. Life support devices or systems are devices or systems which:

1. are intended to implant into the body, or
2. support or sustain life and whose failure to perform when properly used in accordance with instructions for use provided in the labeling can be reasonably expected to result in significant injury to the user.

B. A critical component is any component in a life support device or system whose failure to perform can be reasonably expected to cause the failure of the life support device or to affect its safety or effectiveness.

Customers represent that they have all necessary expertise in the safety and regulatory ramifications of their life support devices or systems, and acknowledge and agree that they are solely responsible for all legal, regulatory and safety-related requirements concerning their products and any use of Diodes Incorporated products in such safety-critical, life support devices or systems, notwithstanding any devices- or systems-related information or support that may be provided by Diodes Incorporated. Further, Customers must fully indemnify Diodes Incorporated and its representatives against any damages arising out of the use of Diodes Incorporated products in such safety-critical, life support devices or systems.

Copyright © 2016, Diodes Incorporated

[www.diodes.com](http://www.diodes.com)



# Mouser Electronics

Authorized Distributor

Click to View Pricing, Inventory, Delivery & Lifecycle Information:

[Diodes Incorporated:](#)

[ZXMP10A13FTA](#)