

THIS DRAWING IS UNPUBLISHED. RELEASED FOR PUBLICATION
 © COPYRIGHT - By - ALL RIGHTS RESERVED.

LOC	DIST	REVISIONS					
BD	35	P	LTR	DESCRIPTION	DATE	DWN	APVD
		A1		REVISED PER ECO-11-004917	11MAR11	RK	HMR

D±0.08 DIA
 [±.003]
 4 HOLES

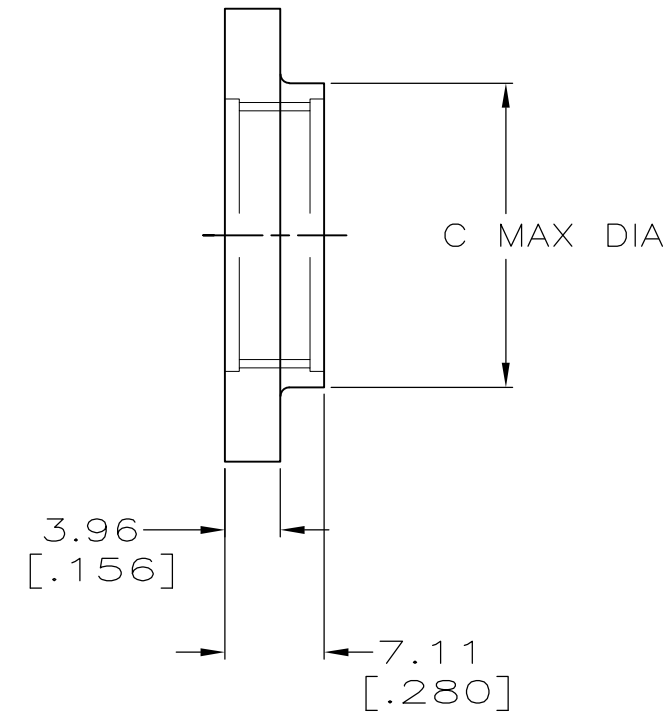
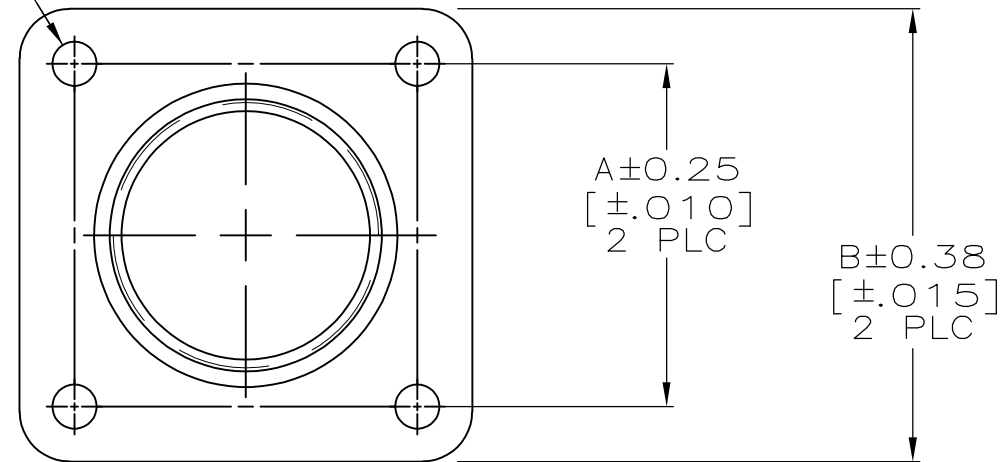

23	3.81 [.150]	38.35 [1.510]	44.45 [1.750]	36.53 [1.438]	207299-4
17	3.81 [.150]	28.19 [1.110]	36.45 [1.435]	28.58 [1.125]	207299-3
13	3.18 [.125]	22.22 [.875]	32.51 [1.280]	24.61 [.969]	207299-2
11	3.18 [.125]	19.05 [.750]	28.58 [1.125]	21.44 [.844]	207299-1
SIZE	D	C	B	A	PART NO

THIS DRAWING IS A CONTROLLED DOCUMENT.

DWN D.HARDY 05/20/94	 TE Connectivity NAME FLANGE, PLUG, CPC				
CHK R.STONE 05/20/94					
APVD A.FRANTUM 07/13/94					
PRODUCT SPEC -					
APPLICATION SPEC -	SIZE A3	CAGE CODE 00779	DRAWING NO C-207299	RESTRICTED TO -	
WEIGHT -	CUSTOMER DRAWING		SCALE 2:1	SHEET 1 of 1	REV A1

THIS DRAWING IS A CONTROLLED DOCUMENT FOR AMP INCORPORATED. IT IS SUBJECT TO CHANGE AND THE CONTROLLING ENGINEERING ORGANIZATION SHOULD BE CONTACTED FOR THE LATEST REVISION.

MATERIAL
 NYLON, BLACK

FINISH
 -

Mouser Electronics

Authorized Distributor

Click to View Pricing, Inventory, Delivery & Lifecycle Information:

[TE Connectivity:](#)

[207299-2](#)