

- NOTES:
- MATERIAL: N - GLASS FILLED POLYESTER, UL94V-0, MOLDED NATURAL
  - FINISH: SEE TERMINAL DRAWINGS
  - PRODUCT SPECIFICATION: PS-08-50, PS-40-02, AND PS-45570-001
  - PACKAGING INFORMATION: SEE LEGEND
  - MATES WITH 3.96/(1.56) CENTER HEADERS AND 1.14/(.045) SQUARE OR ROUND PINS
  - HOUSING ACCEPTS STANDARD TERMINAL NOS.:  
 2478 (18-24 AWG) WITH 2.79/(.110) MAX. INSULATION DIA.  
 2578 (22-26 AWG) WITH 1.65/(.065) MAX. INSULATION DIA.  
 OR TRIFURCON TERMINAL NOS.:  
 6838 (18-24 AWG) WITH 2.79/(.110) MAX. INSULATION DIA.  
 7258 (22-26 AWG) WITH 1.65/(.065) MAX. INSULATION DIA.  
 OR MARKK TERMINAL NO.:  
 45570 (18-20 AWG) WITH 3.12/(.123) MAX. INSULATION DIA.
  - BOW .006 MM/MM / (.006 IN/IN).
  - (0.13)/.005 MAX. FLASH ALLOWED ALONG DIMENSION B AND IN LOCKING WINDOW.
  - THIS PART CONFORMS TO CLASS B REQUIREMENTS OF COSMETIC SPECIFICATION PS-45499-002.
  - GEOMETRY ON THIS SHEET APPLIES TO 7-14 CIRCUIT PARTS WITH WINDOW GEOMETRY. SEE SHEET 2 FOR 7-14 CIRCUIT PARTS WITHOUT WINDOW GEOMETRY. SEE SHEET 3 FOT 2-6 CIRCUIT PARTS WITHOUT WINDOW GEOMETRY.

NO. OF CKTS.	DIM. A REF.	DIM. B
2	8.79 (.346)	3.96±0.05 (.156±.002)
3	12.75 (.502)	7.92±0.08 (.312±.003)
4	16.71 (.658)	11.89±0.08 (.468±.003)
5	20.67 (.814)	15.85±0.08 (.624±.003)
6	24.64 (.970)	19.81±0.10 (.780±.004)
7	28.60 (1.126)	23.77±0.10 (.936±.004)
8	32.56 (1.282)	27.74±0.10 (1.092±.004)
9	36.53 (1.438)	31.70±0.10 (1.248±.004)
10	40.49 (1.594)	35.66±0.15 (1.404±.006)
11	44.45 (1.750)	39.62±0.15 (1.560±.006)
12	48.41 (1.906)	43.59±0.15 (1.716±.006)
13	52.37 (2.062)	47.55±0.15 (1.872±.006)
14	56.34 (2.218)	51.51±0.18 (2.028±.007)

41695 - \* - \* N - ##

MATERIAL CODE  
N=MOLDED NATURAL

VOID CODE  
BLANK=NO VOIDS  
NO.=NO. CORRESPONDS TO CKT. NO. VOIDED  
MULT. VOIDS=START WITH 51

**OPTION CODE D**  
WITH RAMPS AND POLARIZING RIBS

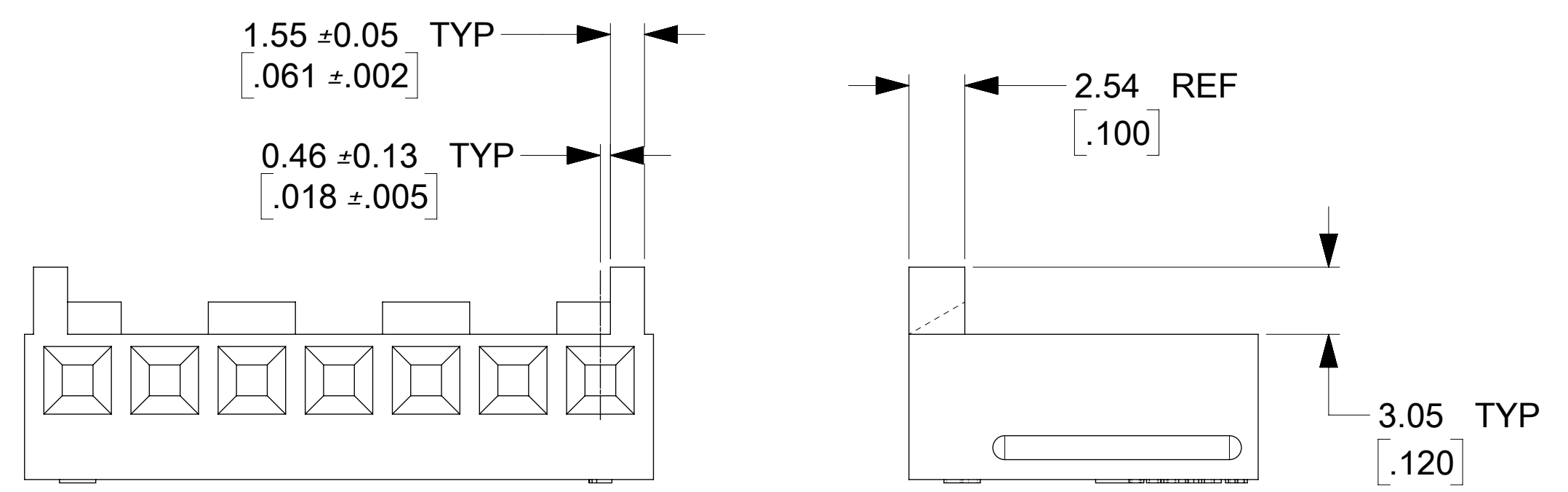

WHEN MATING OPTION CODE D HOUSING WITH BREAKAWAY FRICTION LOCK OR POLARIZING HEADER, THE END FRICTION LOCKS OR POLARIZING WALLS MUST BE REMOVED.

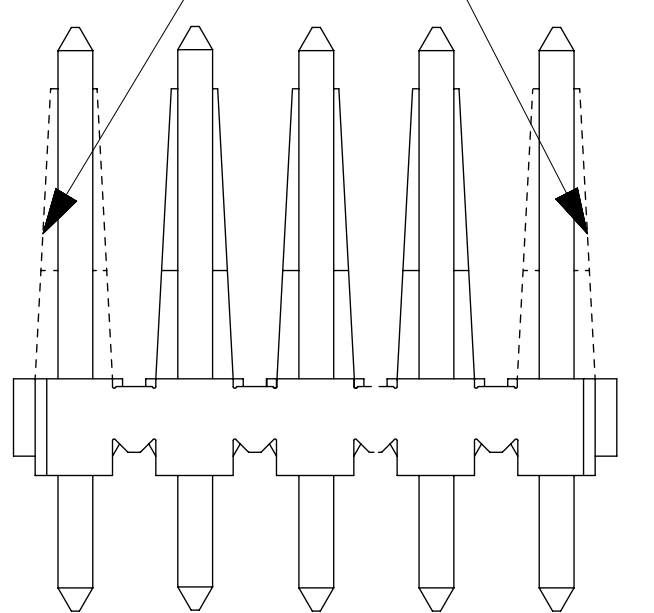

WHEN MATING WITH BREAKAWAY HEADERS THE FRICTION LOCK WALL MUST BE REMOVED

OPTION CODE

CODE	RAMP	POLARIZING RIBS	PACKAGE PER
A	NO	NO	BULK PK-41695-001
B	YES	NO	BULK PK-41695-001
D	YES	YES	BULK PK-41695-001

THIS DRAWING CONTAINS INFORMATION THAT IS PROPRIETARY TO MOLEX ELECTRONIC TECHNOLOGIES, LLC AND SHOULD NOT BE USED WITHOUT WRITTEN PERMISSION

DIMENSION UNITS <b>MM/IN</b>	SCALE <b>4:1</b>	CURRENT REV DESC: 7-14CKT PROD CHANGE	
GENERAL TOLERANCES (UNLESS SPECIFIED)		EC NO: 177792	molex
4 PLACES ±	±	DRWN: RLALSANGI 2018/03/28	
3 PLACES ±	± 0.005	CHK'D: SS06 2018/06/08	KK (3.96)/.156 CRIMP TERMINAL HOUSING
2 PLACES ±	± 0.13 ± 0.01	APPR: ISHWARG 2018/06/08	PRODUCT CUSTOMER DRAWING
1 PLACE ±	± 0.25 ±	INITIAL REVISION:	DOCUMENT NUMBER
0 PLACES ±	±	DRWN: SKOWRONSKI 1986/04/05	<b>SD-41695</b>
ANGULAR TOL ±	± 0.5 °	APPR: FSMITH 2012/01/13	DOC TYPE
DRAFT WHERE APPLICABLE MUST REMAIN WITHIN DIMENSIONS	THIRD ANGLE PROJECTION	DRAWING	DOC PART
		<b>D-SIZE</b>	REVISION
		SERIES	<b>001</b>
		MATERIAL NUMBER	<b>L</b>
		CUSTOMER	SEE CHART
		SHEET NUMBER	GENERAL MARKET
			1 OF 3

### OPTION CODE A

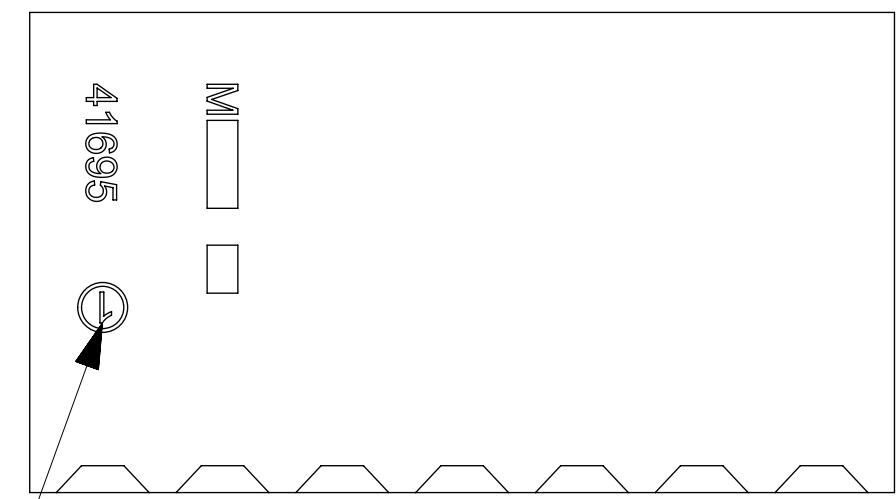

CIRCUIT NUMBER 1

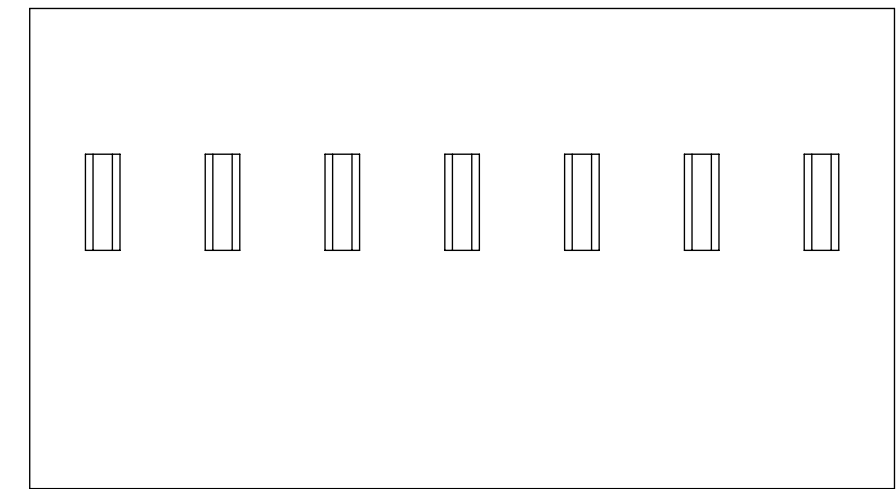
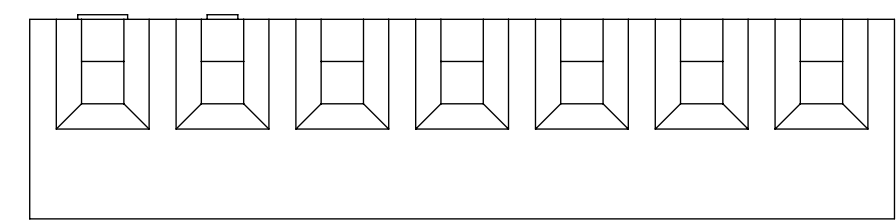

### OPTION CODE B

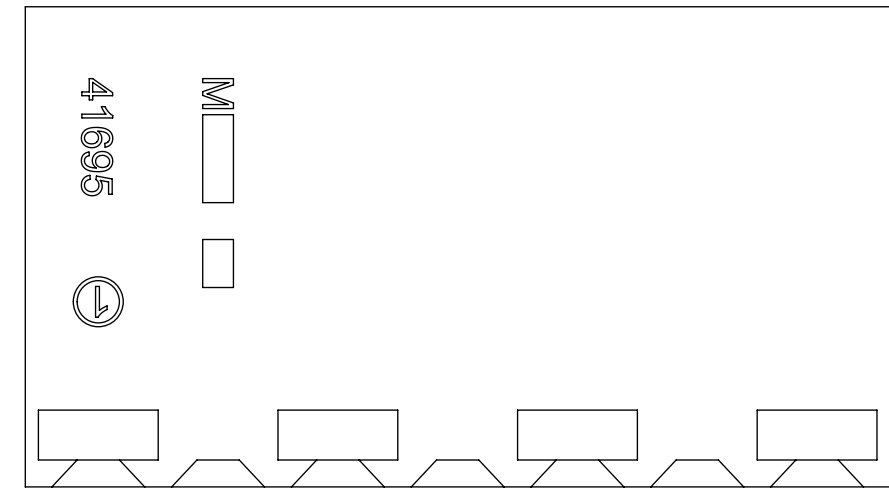

1.47 REF  
[.058]

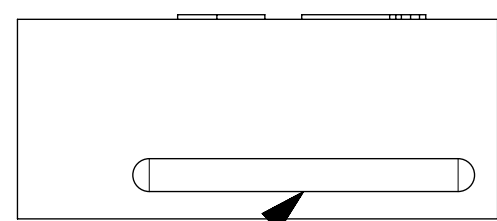

GROOVE MAY BE PRESENT  
(BOTH SIDES)

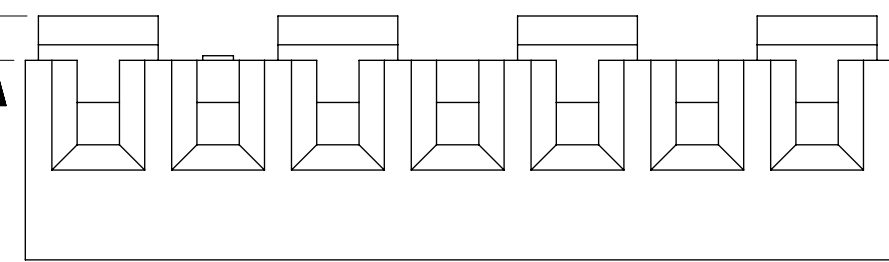

2.54 REF  
[.100]

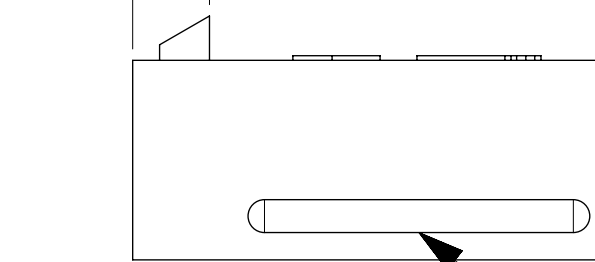

GROOVE MAY BE PRESENT  
(BOTH SIDES)

NOTES:  
GEOMETRY ON THIS SHEET APPLIES TO 7-14 CIRCUIT PARTS WITHOUT WINDOW GEOMETRY.  
SEE SHEET 1 FOR ALL OTHER DIMENSIONS.

### OPTION CODE D

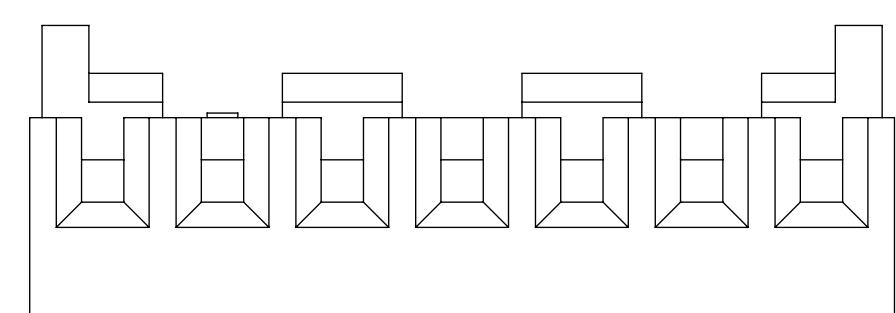
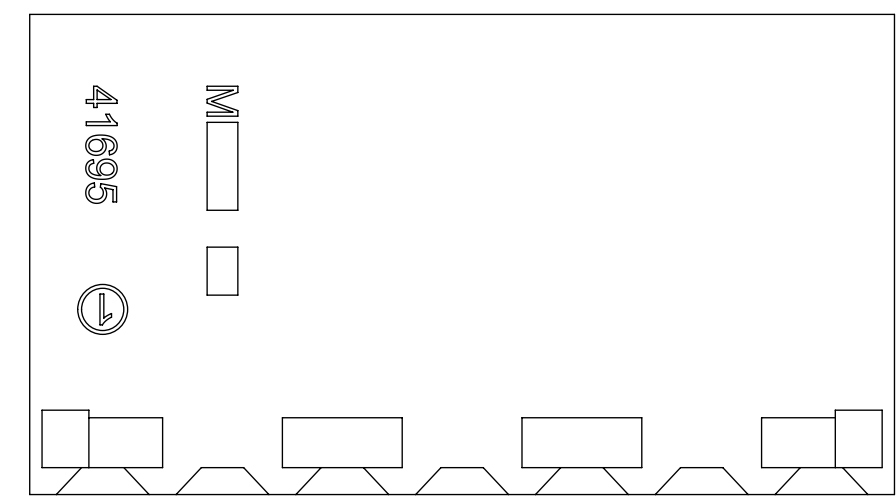

0.89  
[.035]

2.79  
[.110]

3.05 REF  
[.120]

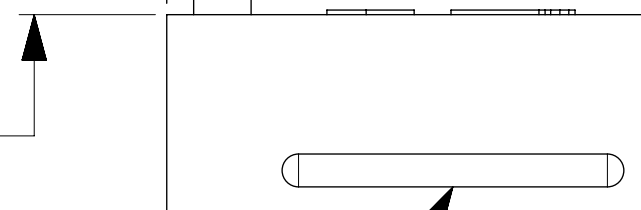

GROOVE MAY BE PRESENT  
(BOTH SIDES)

THIS DRAWING CONTAINS INFORMATION THAT IS PROPRIETARY TO MOLEX ELECTRONIC TECHNOLOGIES, LLC AND SHOULD NOT BE USED WITHOUT WRITTEN PERMISSION

DIMENSION UNITS		SCALE		CURRENT REV DESC: 7-14CKT PROD CHANGE		<b>molex</b>	
MM/IN		4:1					
GENERAL TOLERANCES (UNLESS SPECIFIED)				EC NO: 177792		KK (3.96)/.156 CRIMP TERMINAL HOUSING	
4 PLACES	±		±	DRWN: RLALSANGI	2018/03/28	PRODUCT CUSTOMER DRAWING	
3 PLACES	±	0.13	±	CHK'D: SS06	2018/06/08	DOCUMENT NUMBER	
2 PLACES	±	0.13	±	APPR: ISHWARG	2018/06/08	DOC TYPE	
1 PLACE	±	0.25	±	INITIAL REVISION:		DOC PART	
0 PLACES	±		±	DRWN: SKOWRONSKI	1986/04/05	REVISION	
ANGULAR TOL ± 0.5°				APPR: FSMITH	2012/01/13	SD-41695	
DRAFT WHERE APPLICABLE MUST REMAIN WITHIN DIMENSIONS		THIRD ANGLE PROJECTION		DRAWING	SERIES	MATERIAL NUMBER	CUSTOMER
				D-SIZE	41695	SEE CHART	GENERAL MARKET
							SHEET NUMBER
							2 OF 3

### OPTION CODE A

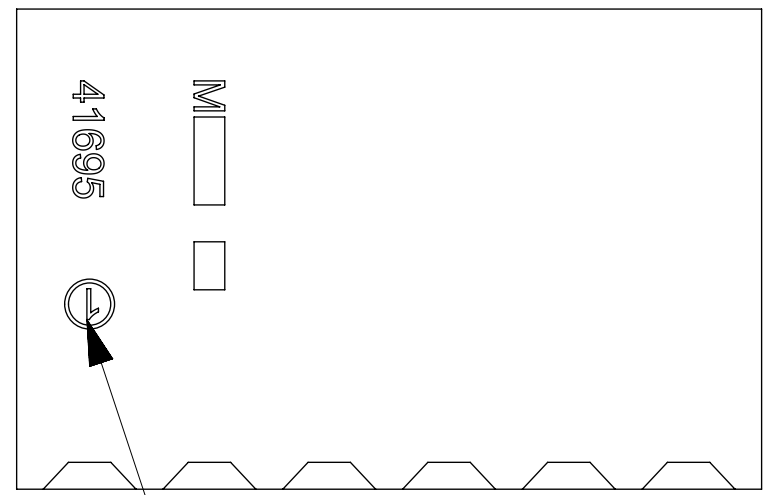

CIRCUIT NUMBER 1

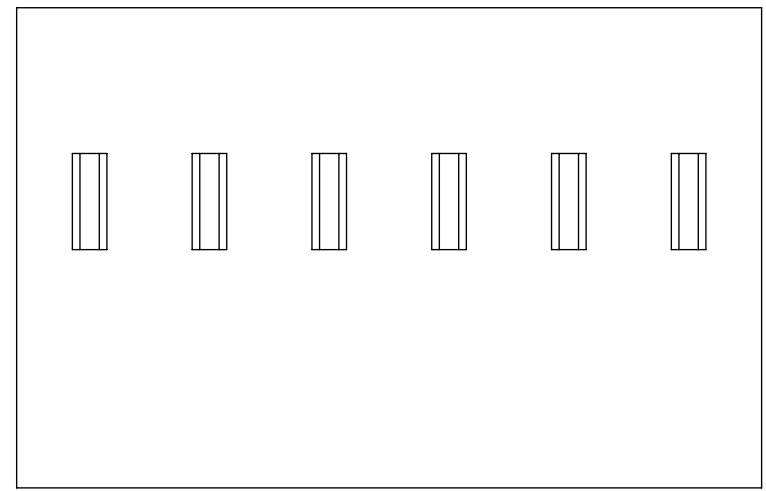
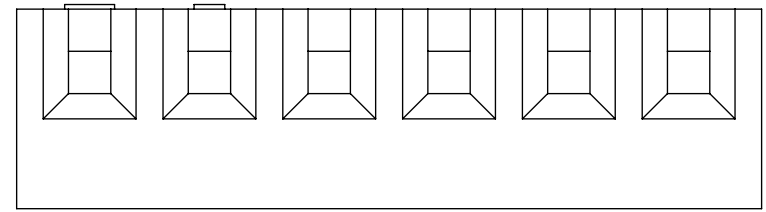

### OPTION CODE B

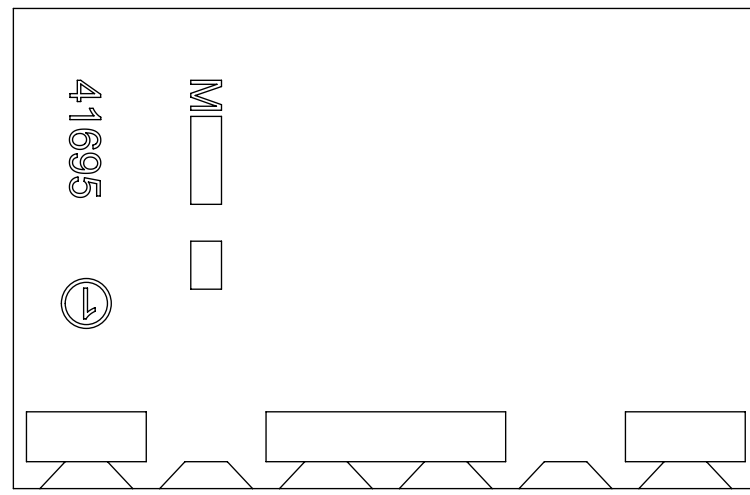

1.47 REF  
[.058]

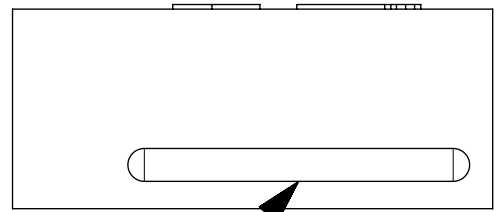

GROOVE MAY BE PRESENT  
(BOTH SIDES)

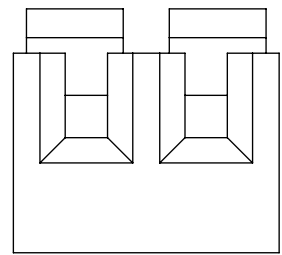

2.54 REF  
[.100]

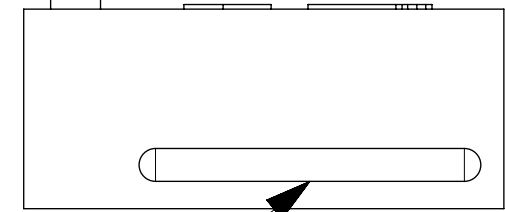

GROOVE MAY BE PRESENT  
(BOTH SIDES)

### OPTION CODE D

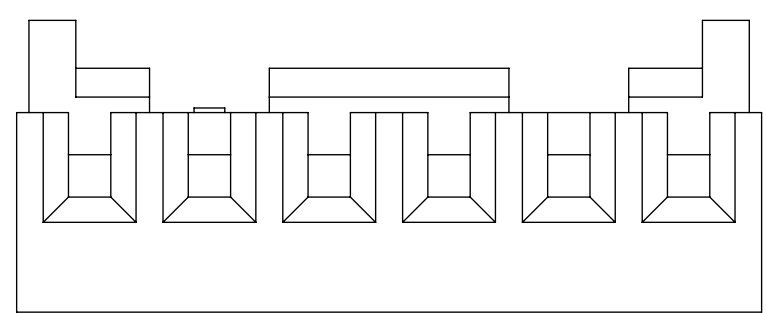
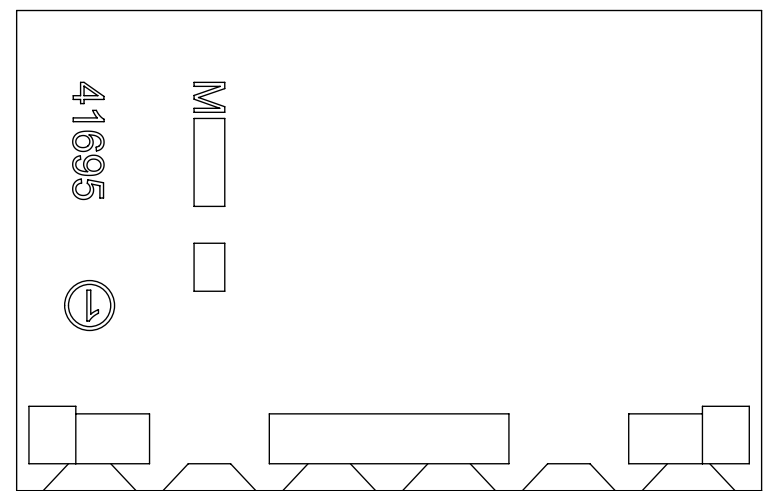

3.05 REF  
[.120]

0.89  
[.035]

2.79  
[.110]

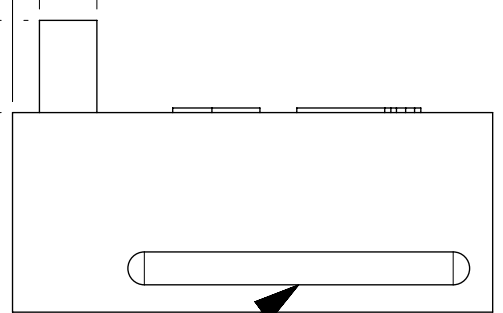

GROOVE MAY BE PRESENT  
(BOTH SIDES)

NOTES:  
GEOMETRY ON THIS SHEET APPLIES TO 2-6 CIRCUIT PARTS WITHOUT WINDOW GEOMETRY.  
SEE SHEET 1 FOR ALL OTHER DIMENSIONS.

41695-N-AN-*		
PART NO.	ENG. NO.	VOIDS
	NOT AVAILABLE	
09-50-8020	41695-N-A2	
09-50-8030	41695-N-A3	
09-50-8040	41695-N-A4	
09-50-8050	41695-N-A5	
09-50-8060	41695-N-A6	
09-50-8070	41695-N-A7	
09-50-8080	41695-N-A8	
09-50-8090	41695-N-A9	
09-50-8100	41695-N-A10	
09-50-8110	41695-N-A11	
09-50-8120	41695-N-A12	
09-50-9085	41695-N-A8-2	2
41695-0001	41695-N-A6-3	3
41695-0002	41695-N-A5-4	4

41695-N-BN-*		
PART NO.	ENG. NO.	VOIDS
	NOT AVAILABLE	
09-50-8021	41695-N-B2	
09-50-8031	41695-N-B3	
09-50-8041	41695-N-B4	
09-50-8051	41695-N-B5	
09-50-8061	41695-N-B6	
09-50-8071	41695-N-B7	
09-50-8081	41695-N-B8	
09-50-8091	41695-N-B9	
09-50-8101	41695-N-B10	
09-50-8111	41695-N-B11	
09-50-8121	41695-N-B12	
09-50-8131	41695-N-B13	
09-50-8141	41695-N-B14	
09-50-9030	41695-N-B3-2	2
	41695-N-B4-2	2
	41695-N-B5-2	2
	41695-N-B9-2	2
	41695-N-B11-2	2
09-50-9121	41695-N-B12-2	2
	41695-N-B14-2	2
09-50-9060	41695-N-B6-5	5
09-50-9070	41695-N-B7-6	6
09-50-9071	41695-N-B7-2	2
09-50-9040	41695-N-B4-3	3
09-50-9090	41695-N-B9-7	7
	41695-N-B14-13	13
09-50-9136	41695-N-B13-5	5
09-50-9137	41695-N-B13-8	8
09-50-9050	41695-N-B5-51	2,4
09-50-9061	41695-N-B6-3	3
09-50-9080	41695-N-B8-2	2
41695-0005	41695-N-B7-3	3
41695-0006	41695-N-B14-51	5,9

41695-N-DN-*		
PART NO.	ENG. NO.	VOIDS
	NOT AVAILABLE	
09-50-8023	41695-N-D2	
09-50-8033	41695-N-D3	
09-50-8043	41695-N-D4	
09-50-8053	41695-N-D5	
09-50-8063	41695-N-D6	
09-50-8073	41695-N-D7	
09-50-8083	41695-N-D8	
09-50-8093	41695-N-D9	
09-50-8103	41695-N-D10	
09-50-8113	41695-N-D11	
09-50-8123	41695-N-D12	
09-50-8133	41695-N-D13	
09-50-8143	41695-N-D14	
09-50-9053	41695-N-D5-2	2
09-50-9094	41695-N-D9-3	3
09-50-9033	41695-N-D3-2	2
09-50-9043	41695-N-D4-2	2
09-50-9063	41695-N-D6-2	2
09-50-9073	41695-N-D7-2	2
09-50-9044	41695-N-D4-3	3
41695-0003	41695-N-D07-5	5

THIS DRAWING CONTAINS INFORMATION THAT IS PROPRIETARY TO MOLEX ELECTRONIC TECHNOLOGIES, LLC AND SHOULD NOT BE USED WITHOUT WRITTEN PERMISSION

DIMENSION UNITS <b>MM/IN</b>	SCALE <b>4:1</b>	CURRENT REV DESC: 7-14CKT PROD CHANGE
GENERAL TOLERANCES (UNLESS SPECIFIED)		EC NO: 177792
4 PLACES ±	±	DRWN: RLALSANGI 2018/03/28
3 PLACES ±	± 0.005	CHK'D: SS06 2018/06/08
2 PLACES ±	± 0.13 ± 0.01	APPR: ISHWARG 2018/06/08
1 PLACE ±	± 0.25 ±	INITIAL REVISION:
0 PLACES ±	±	DRWN: SKOWRONSKI 1986/04/05
ANGULAR TOL ±	± 0.5 °	APPR: FSMITH 2012/01/13
DRAFT WHERE APPLICABLE MUST REMAIN WITHIN DIMENSIONS	THIRD ANGLE PROJECTION	DRAWING SERIES <b>D-SIZE 41695</b>

KK (3.96)/.156 CRIMP TERMINAL HOUSING

PRODUCT CUSTOMER DRAWING

DOCUMENT NUMBER: **SD-41695**    DOC TYPE: PSD    DOC PART: 001    REVISION: L

MATERIAL NUMBER: SEE CHART    CUSTOMER: GENERAL MARKET    SHEET NUMBER: 3 OF 3

# Mouser Electronics

Authorized Distributor

Click to View Pricing, Inventory, Delivery & Lifecycle Information:

[Molex:](#)

[09-50-9044](#)