

END OF LIFE



IRF7404QPbF

HEXFET® Power MOSFET

- Advanced Process Technology
- Ultra Low On-Resistance
- P Channel MOSFET
- Surface Mount
- Available in Tape & Reel
- 150°C Operating Temperature
- Lead-Free

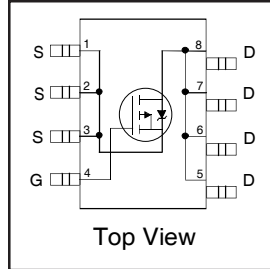

$V_{DSS} = -20V$
$R_{DS(on)} = 0.040\Omega$

Description

These HEXFET® Power MOSFET's in package utilize the latest processing techniques to achieve extremely low on-resistance per silicon area. Additional features of these HEXFET Power MOSFET's are a 150°C junction operating temperature, fast switching speed and improved repetitive avalanche rating. These benefits combine to make this design an extremely efficient and reliable device for use in a wide variety of applications.

The efficient SO-8 package provides enhanced thermal characteristics making it ideal in a variety of power applications. This surface mount SO-8 can dramatically reduce board space and is also available in Tape & Reel.

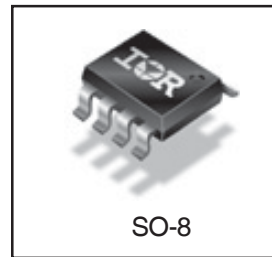

Base part number	Orderable part number	Package Type	Standard Pack		EOL Notice	Replacement Part Number
			Form	Quantity		
IRF7404QPbF	IRF7404QTRPbF	SO-8	Tape and Reel	4000	EOL 527	Please search the EOL part number on IR's website for guidance
	IRF7404QPbF	SO-8	Tube	95	EOL 529	

Absolute Maximum Ratings

	Parameter	Max.	Units
$I_D @ T_A = 25^\circ C$	10 Sec. Pulsed Drain Current, $V_{GS} @ -4.5V$	-7.7	A
$I_D @ T_A = 25^\circ C$	Continuous Drain Current, $V_{GS} @ -4.5V$	-6.7	
$I_D @ T_A = 70^\circ C$	Continuous Drain Current, $V_{GS} @ -4.5V$	-5.4	
I_{DM}	Pulsed Drain Current ①	-27	
$P_D @ T_A = 25^\circ C$	Power Dissipation	2.5	W
	Linear Derating Factor	0.02	W/°C
V_{GS}	Gate-to-Source Voltage	± 12	V
dv/dt	Peak Diode Recovery dv/dt ②	-5.0	V/ns
T_J, T_{STG}	Junction and Storage Temperature Range	-55 to + 150	°C

Thermal Resistance Ratings

	Parameter	Typ.	Max.	Units
$R_{\theta JA}$	Maximum Junction-to-Ambient③	---	50	°C/W

END OF LIFE

IRF7404QPbF

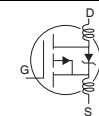

Electrical Characteristics @ T_J = 25°C (unless otherwise specified)

	Parameter	Min.	Typ.	Max.	Units	Conditions
V _{(BR)DSS}	Drain-to-Source Breakdown Voltage	-20	—	—	V	V _{GS} = 0V, I _D = -250μA
ΔV _{(BR)DSS/ΔT_J}	Breakdown Voltage Temp. Coefficient	—	-0.012	—	V/°C	Reference to 25°C, I _D = -1mA
R _{D(S)ON}	Static Drain-to-Source On-Resistance	—	—	0.040	Ω	V _{GS} = -4.5V, I _D = -3.2A ③
		—	—	0.060		V _{GS} = -2.7V, I _D = -2.7A ③
V _{GS(th)}	Gate Threshold Voltage	-0.70	—	—	V	V _{DS} = V _{GS} , I _D = -250μA
g _{fs}	Forward Transconductance	6.8	—	—	S	V _{DS} = -15V, I _D = -3.2A
I _{DSS}	Drain-to-Source Leakage Current	—	—	-1.0	μA	V _{DS} = -16V, V _{GS} = 0V
		—	—	-25		V _{DS} = -16V, V _{GS} = 0V, T _J = 125°C
I _{GSS}	Gate-to-Source Forward Leakage	—	—	-100	nA	V _{GS} = -12V
	Gate-to-Source Reverse Leakage	—	—	100		V _{GS} = 12V
Q _g	Total Gate Charge	—	—	50	nC	I _D = -3.2A
Q _{gs}	Gate-to-Source Charge	—	—	5.5		V _{DS} = -16V
Q _{gd}	Gate-to-Drain ("Miller") Charge	—	—	21		V _{GS} = -4.5V, See Fig. 6 and 12 ③
t _{d(on)}	Turn-On Delay Time	—	14	—	ns	V _{DD} = -10V
t _r	Rise Time	—	32	—		I _D = -3.2A
t _{d(off)}	Turn-Off Delay Time	—	100	—		R _G = 6.0Ω
t _f	Fall Time	—	65	—		R _D = 3.1Ω, See Fig. 10 ③
L _D	Internal Drain Inductance	—	2.5	—	nH	Between lead tip and center of die contact 
L _S	Internal Source Inductance	—	4.0	—		
C _{iss}	Input Capacitance	—	1500	—	pF	V _{GS} = 0V
C _{oss}	Output Capacitance	—	730	—		V _{DS} = -15V
C _{rss}	Reverse Transfer Capacitance	—	340	—		f = 1.0MHz, See Fig. 5

Source-Drain Ratings and Characteristics

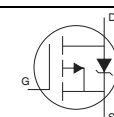
	Parameter	Min.	Typ.	Max.	Units	Conditions
I _S	Continuous Source Current (Body Diode)	—	—	-3.1	A	MOSFET symbol showing the integral reverse p-n junction diode. 
I _{SM}	Pulsed Source Current (Body Diode) ①	—	—	-27		
V _{SD}	Diode Forward Voltage	—	—	-1.0	V	T _J = 25°C, I _S = -2.0A, V _{GS} = 0V ③
t _{rr}	Reverse Recovery Time	—	69	100	ns	T _J = 25°C, I _F = -3.2A
Q _{rr}	Reverse Recovery Charge	—	71	110	μC	di/dt = 100A/μs ③
t _{on}	Forward Turn-On Time	Intrinsic turn-on time is negligible (turn-on is dominated by L _S +L _D)				

Notes:

- ① Repetitive rating; pulse width limited by max. junction temperature. (See fig. 11)
- ② I_{SD} ≤ -3.2A, di/dt ≤ -65A/μs, V_{DD} ≤ V_{(BR)DSS}, T_J ≤ 150°C
- ③ Pulse width ≤ 300μs; duty cycle ≤ 2%.
- ④ Surface mounted on FR-4 board, t ≤ 10sec.

END OF LIFE



IRF7404QPbF

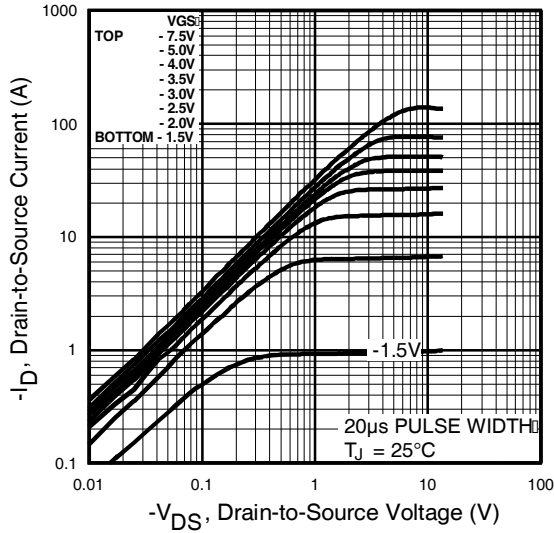

Fig 1. Typical Output Characteristics

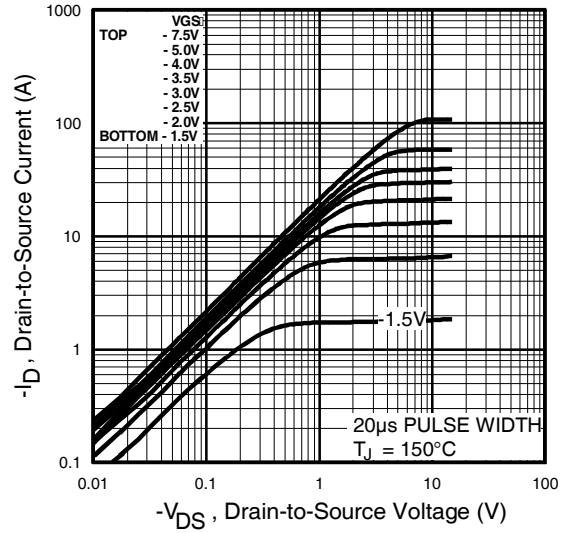

Fig 2. Typical Output Characteristics

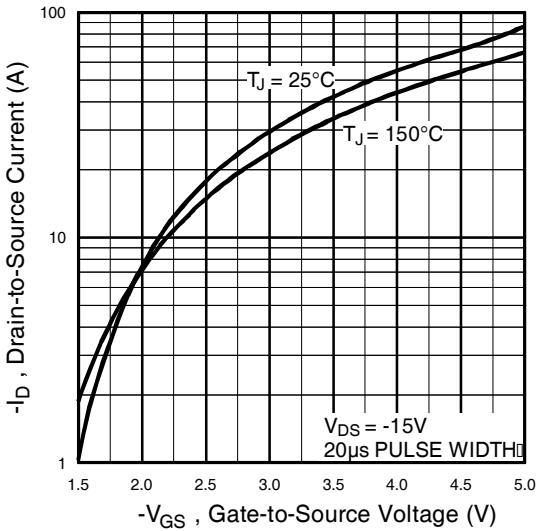

Fig 3. Typical Transfer Characteristics

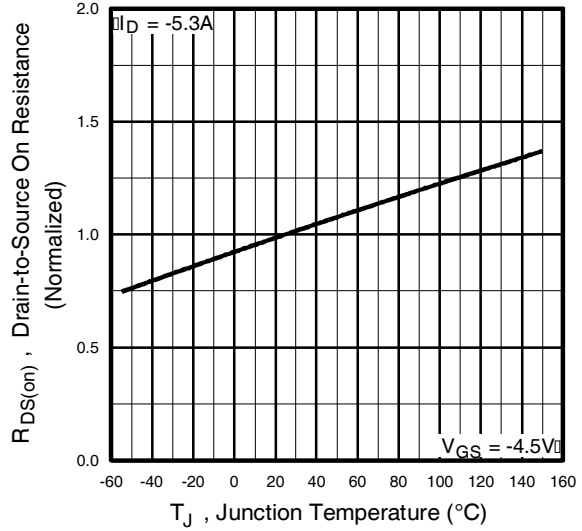

Fig 4. Normalized On-Resistance Vs. Temperature

IRF7404QPbF

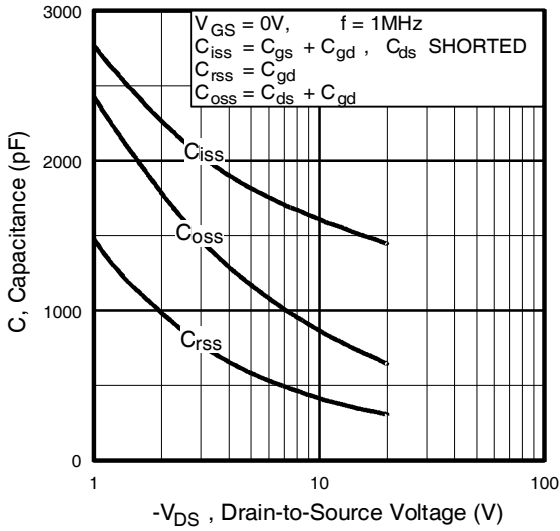

Fig 5. Typical Capacitance Vs. Drain-to-Source Voltage

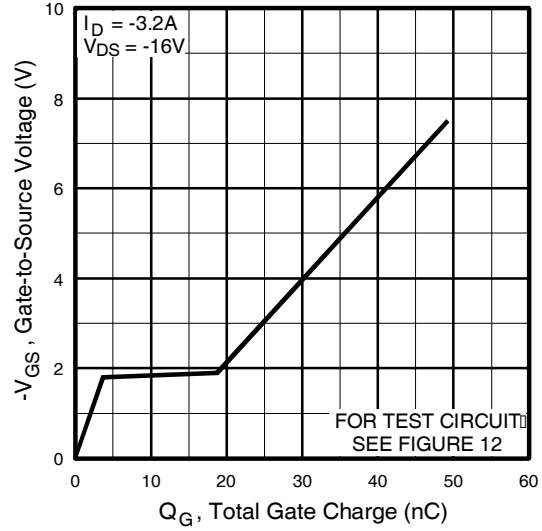

Fig 6. Typical Gate Charge Vs. Gate-to-Source Voltage

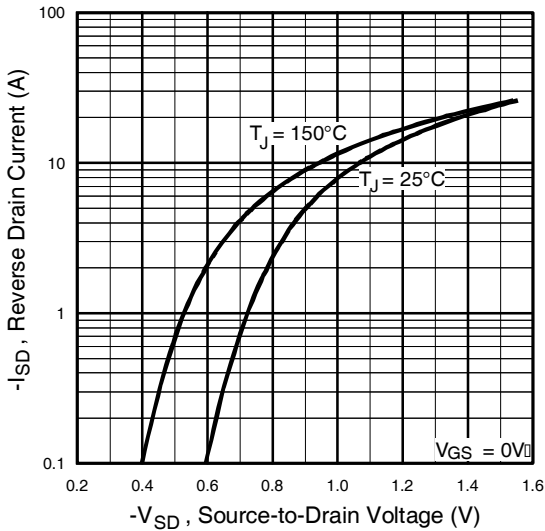

Fig 7. Typical Source-Drain Diode Forward Voltage

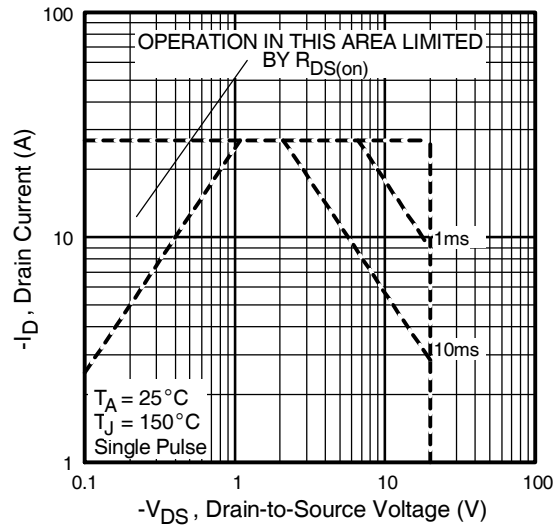

Fig 8. Maximum Safe Operating Area

END OF LIFE



IRF7404QPbF

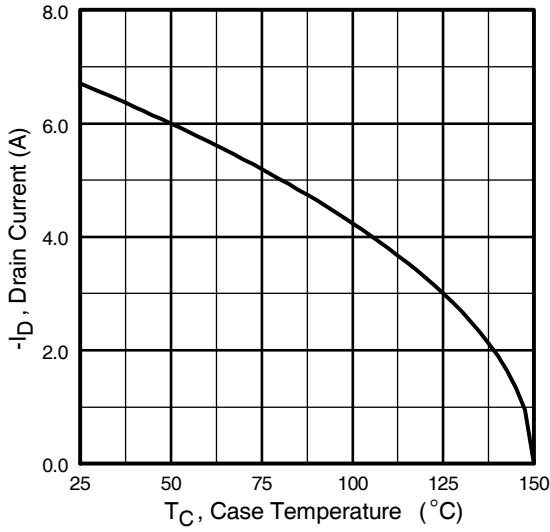

Fig 9. Maximum Drain Current Vs. Ambient Temperature

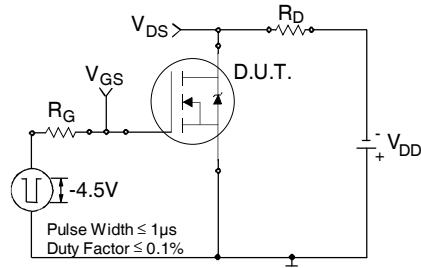

Fig 10a. Switching Time Test Circuit

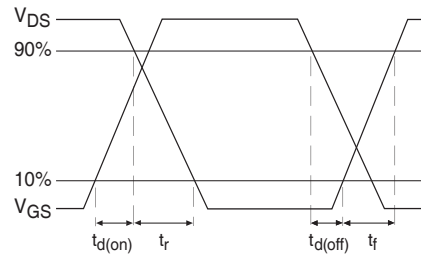

Fig 10b. Switching Time Waveforms

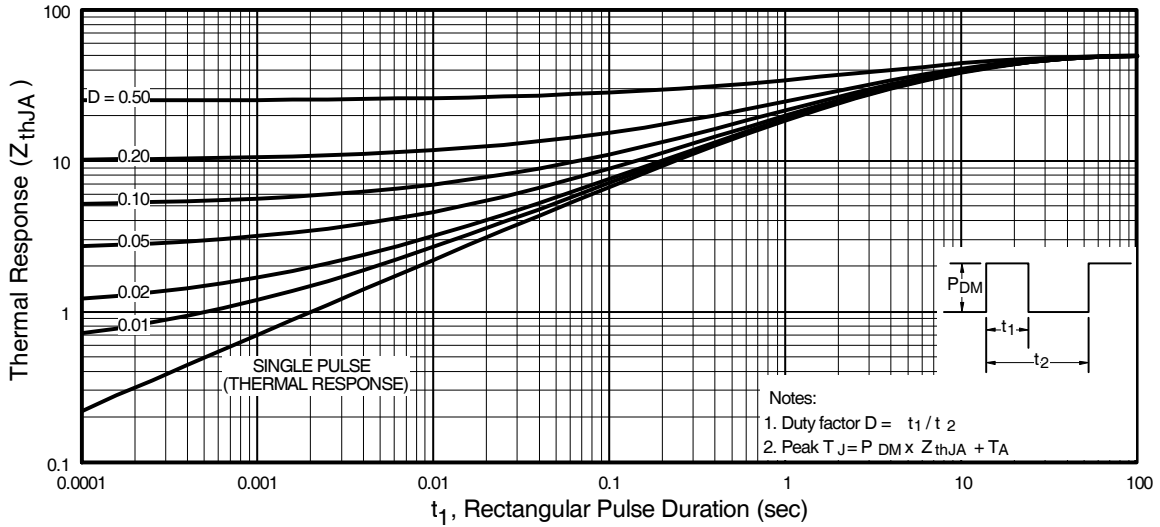

Fig 11. Maximum Effective Transient Thermal Impedance, Junction-to-Ambient

END OF LIFE

IRF7404QPbF

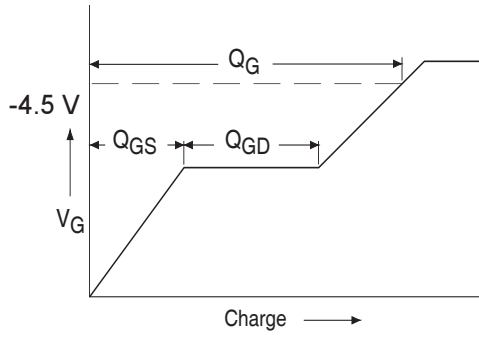

Fig 12a. Basic Gate Charge Waveform

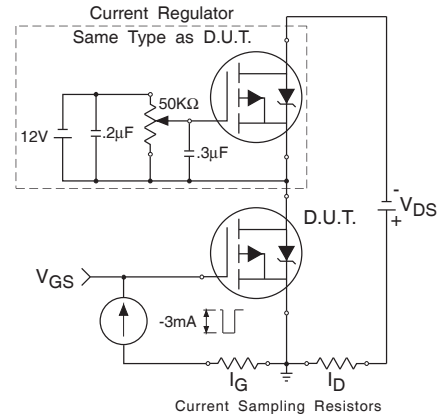

Fig 12b. Gate Charge Test Circuit



END OF LIFE

IRF7404QPbF

Peak Diode Recovery dv/dt Test Circuit

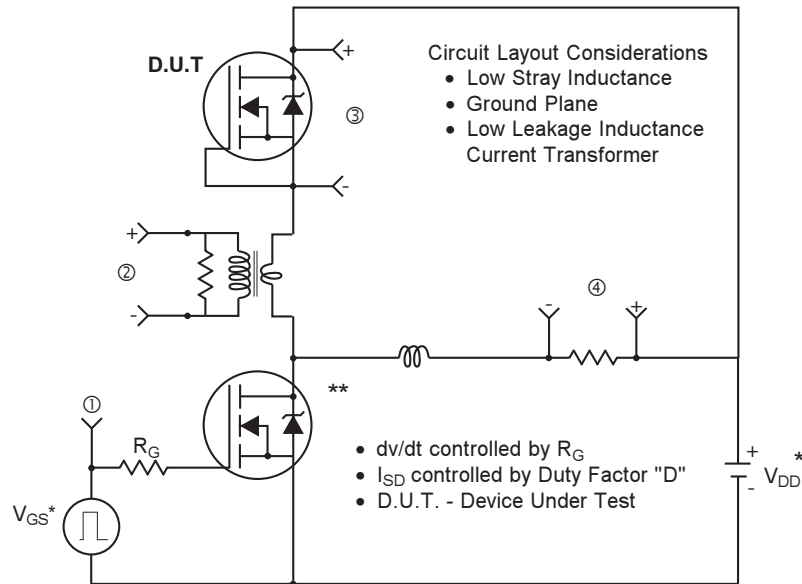

* Reverse Polarity for P-Channel

** Use P-Channel Driver for P-Channel Measurements

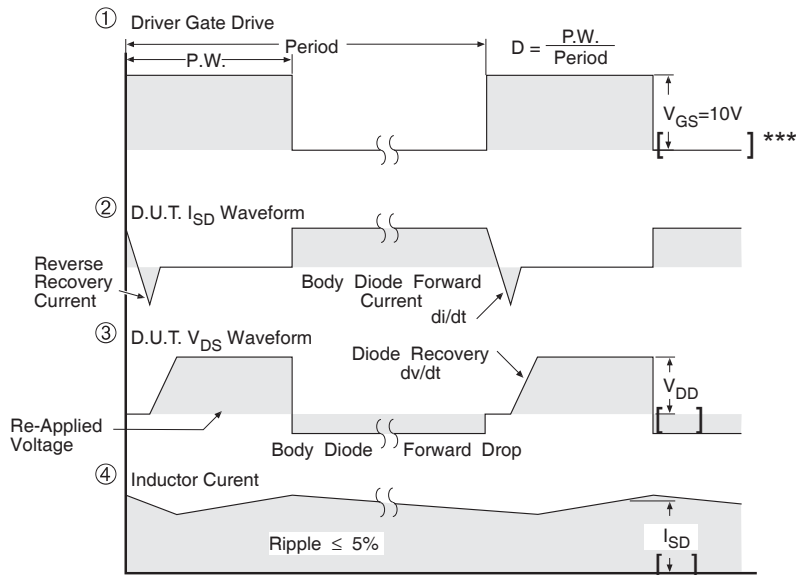

*** $V_{GS} = 5.0V$ for Logic Level and $3V$ Drive Devices

Fig 13. For P-Channel HEXFETS

END OF LIFE

IRF7404QPbF



SO-8 Package Outline

Dimensions are shown in millimeters (inches)

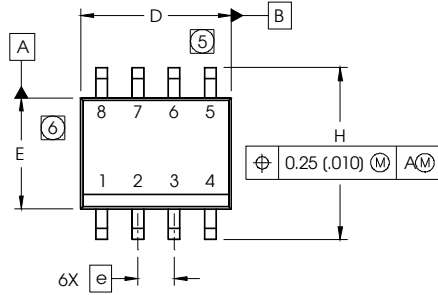

DIM	INCHES		MILLIMETERS	
	MIN	MAX	MIN	MAX
A	.0532	.0688	1.35	1.75
A1	.0040	.0098	0.10	0.25
b	.013	.020	0.33	0.51
c	.0075	.0098	0.19	0.25
D	.189	.1968	4.80	5.00
E	.1497	.1574	3.80	4.00
e	.050 BASIC		1.27 BASIC	
e1	.025 BASIC		0.635 BASIC	
H	.2284	.2440	5.80	6.20
K	.0099	.0196	0.25	0.50
L	.016	.050	0.40	1.27
y	0°	8°	0°	8°

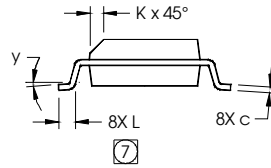
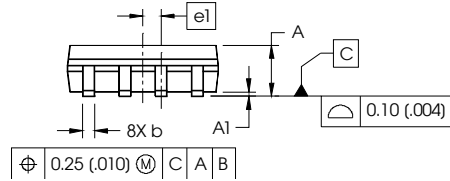

NOTES:

1. DIMENSIONING & TOLERANCING PER ASME Y14.5M-1994.
2. CONTROLLING DIMENSION: MILLIMETER
3. DIMENSIONS ARE SHOWN IN MILLIMETERS (INCHES).
4. OUTLINE CONFORMS TO JEDEC OUTLINE MS-012AA.
- ⑤ DIMENSION DOES NOT INCLUDE MOLD PROTRUSIONS. MOLD PROTRUSIONS NOT TO EXCEED 0.15 (.006).
- ⑥ DIMENSION DOES NOT INCLUDE MOLD PROTRUSIONS. MOLD PROTRUSIONS NOT TO EXCEED 0.25 (.010).
- ⑦ DIMENSION IS THE LENGTH OF LEAD FOR SOLDERING TO A SUBSTRATE.

FOOTPRINT

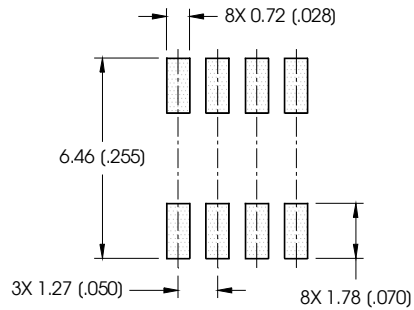

SO-8 Part Marking

EXAMPLE: THIS IS AN IRF7101 (MOSFET)

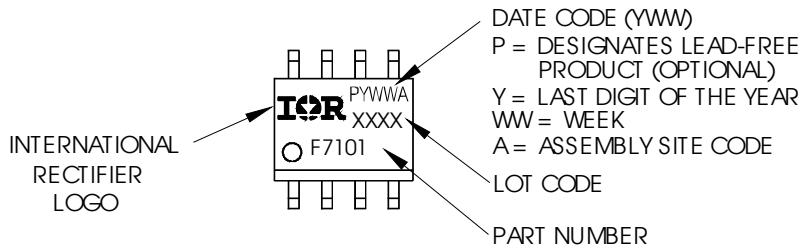

Notes:

1. For an Automotive Qualified version of this part please see : <http://www.irf.com/product-info/auto/>
2. For the most current drawing please refer to IR website at <http://www.irf.com/package/>

END OF LIFE



IRF7404QPbF

SO-8 Tape and Reel

Dimensions are shown in millimeters (inches)

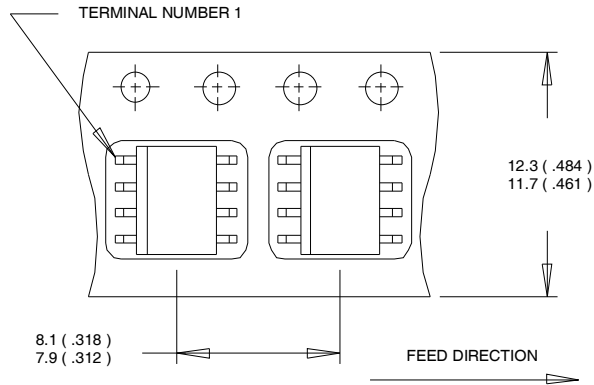

NOTES:

1. CONTROLLING DIMENSION : MILLIMETER.
2. ALL DIMENSIONS ARE SHOWN IN MILLIMETERS(INCHES).
3. OUTLINE CONFORMS TO EIA-481 & EIA-541.

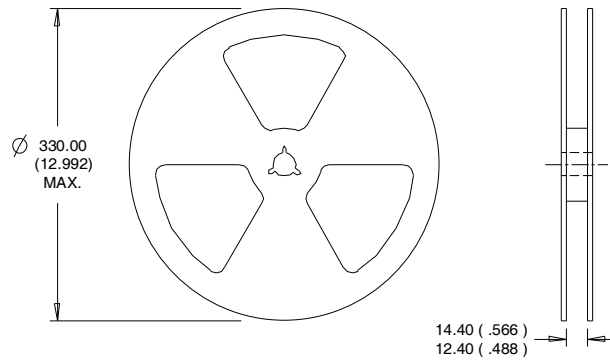

NOTES :

1. CONTROLLING DIMENSION : MILLIMETER.
2. OUTLINE CONFORMS TO EIA-481 & EIA-541.

For the most current drawing please refer to IR website at <http://www.irf.com/package/>

END OF LIFE

IRF7404QPbF



Qualification Information[†]

Qualification level	Industrial [†]	
	(per JEDEC JESD47F ^{††} guidelines)	
Moisture Sensitivity Level	SO-8	MSL1 (per JEDEC J-STD-020D ^{††})
RoHS Compliant	Yes	

[†] Qualification standards can be found at International Rectifier's web site
<http://www.irf.com/product-info/reliability>

^{††} Applicable version of JEDEC standard at the time of product release.

Revision History

Date	Comments
2/10/2015	• Added ordering information to reflect the End-Of-life

International
IR Rectifier

IR WORLD HEADQUARTERS: 101 N. Sepulveda Blvd., El Segundo, California 90245, USA

To contact International Rectifier, please visit <http://www.irf.com/whoto-call/>