

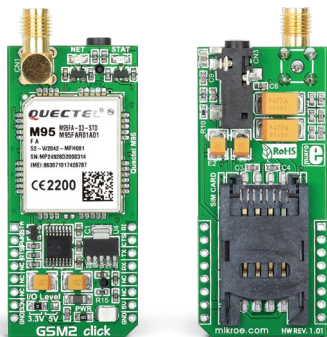

GSM2 click



1. Introduction

GSM2 click is an accessory board in **mikroBUS™** form factor. It's a compact and easy solution for adding a GSM module to your design. It carries a **Quectel M95 FA** GSM module, audio connector, SIM card socket as well as an SMA antenna connector. GSM2 click communicates with target board microcontroller via mikroBUS™ UART [Tx, Rx], PWM, INT, AN, RST and CS lines. The board is designed to use 3.3V and 5V I/O voltage levels. LED diode [GREEN] indicates the presence of a power supply.

2. Soldering the headers

Before using your click board™, make sure to solder 1x8 male headers to both left and right side of the board. Two 1x8 male headers are included with the board in the package.

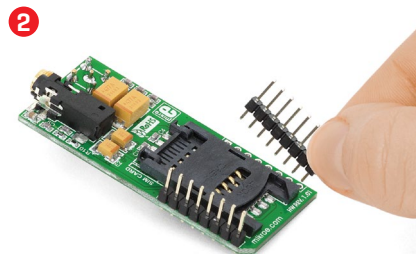
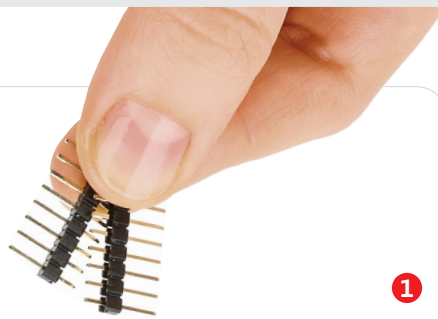

Turn the board upside down so that the bottom side is facing you upwards. Place shorter pins of the header into the appropriate soldering pads.

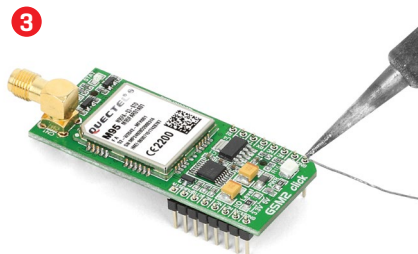

Turn the board upward again. Make sure to align the headers so that they are perpendicular to the board, then solder the pins carefully.

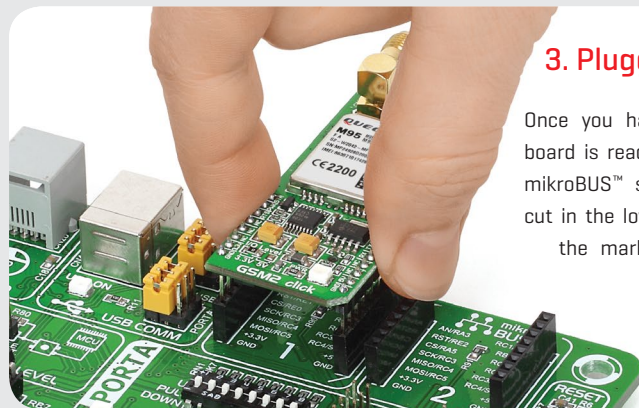

3. Plugging the board in

Once you have soldered the headers your board is ready to be placed into the desired mikroBUS™ socket. Make sure to align the cut in the lower-right part of the board with the markings on the silkscreen at the mikroBUS™ socket. If all the pins are aligned correctly, push the board all the way into the socket.

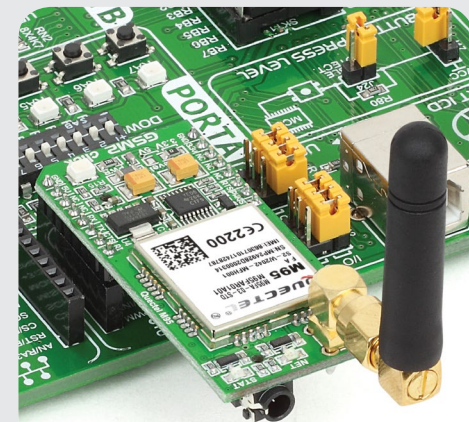

4. Essential features

GSM2 click with its **Quectel M95 FA** IC is ideal for mobile devices. The module is a quad-band GSM/GPRS engine that works at frequencies of GSM850MHz, GSM900MHz, DCS1800MHz or PCS1900MHz with 85.6 kbps GPRS data transfer. It supports internet service protocols, such as TCP/IP, UDP, FTP and PPP.

click
BOARD™
www.mikroe.com



GSM2 click manual
ver 1.01b



5. Schematic

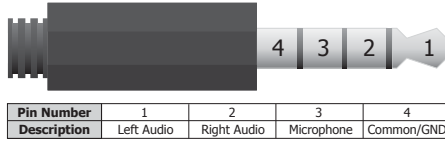
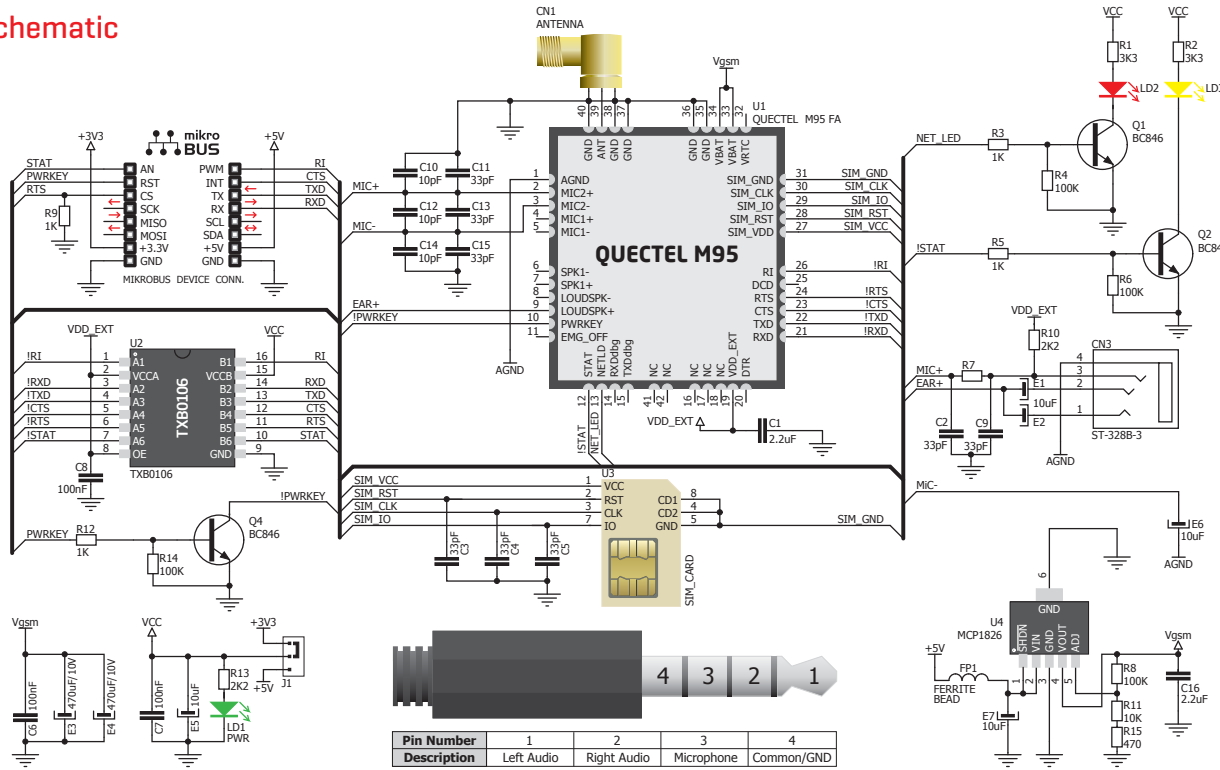

6. Dimensions

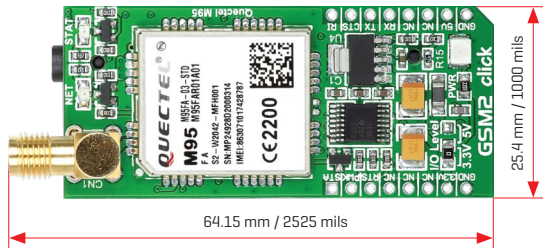

	mm	mils
LENGTH	64.15	2525
WIDTH	25.4	1000
HEIGHT*	16	630

* without headers

8. Code examples

Once you have done all the necessary preparations, it's time to get your click board™ up and running. We have provided examples for mikroC™, mikroBasic™ and mikroPascal™ compilers on our **Libstock** website. Just download them and you are ready to start.



9. Support

MikroElektronika offers **free tech support** [www.mikroe.com/support] until the end of the product's lifetime, so if something goes wrong, we're ready and willing to help!



7. SMD jumper



There is one zero-ohm SMD jumper J1 used to select whether 3.3V [default] or 5V I/O voltage level is used. Note that, regardless of the logic level, the module requires a 5V power supply in both cases.

10. Disclaimer

MikroElektronika assumes no responsibility or liability for any errors or inaccuracies that may appear in the present document. Specification and information contained in the present schematic are subject to change at any time without notice.

Copyright © 2015 MikroElektronika.
All rights reserved.

Mouser Electronics

Authorized Distributor

Click to View Pricing, Inventory, Delivery & Lifecycle Information:

[MikroElektronika:](#)

[MIKROE-1375](#)