

REVOLUTIONS		DATE	DWN	APVD
LOC	DIST	DESCRIPTION		
A2	REVISED PER	ECO-15-003687	10MAR2015	AP DD

1 INTERPRET GEOMETRIC CHARACTERISTIC SYMBOLS PER STANDARD ANSI Y14.5M (1982).
 OBSOLETE PARTS: OBSOLETE CIS STREAMLINING PER D.RENAUD/D.SINISI

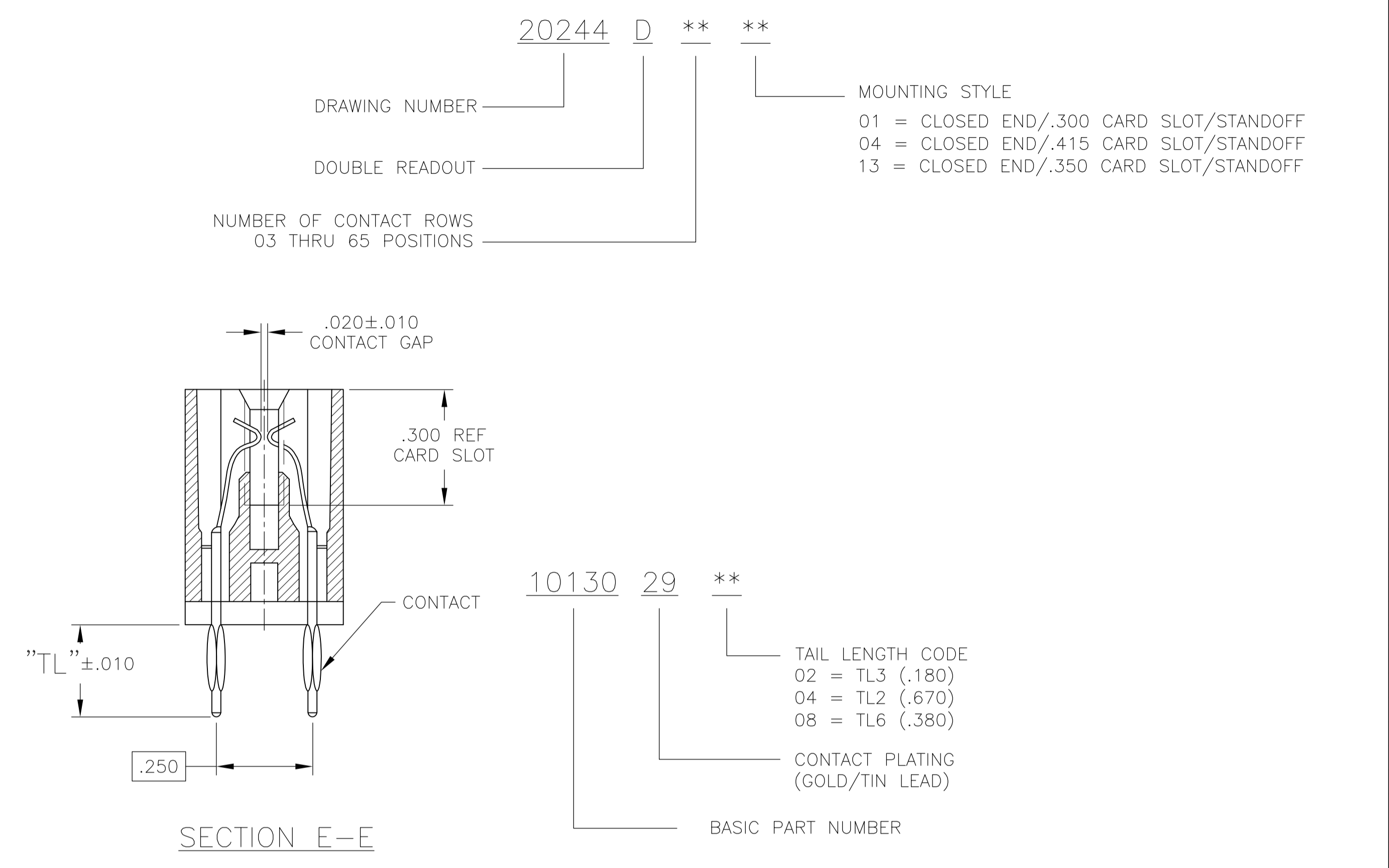

MOUNTING STYLE "01", 20 POSITION ILLUSTRATED
 (ADDITIONAL MOUNTING STYLES AS SHOWN)

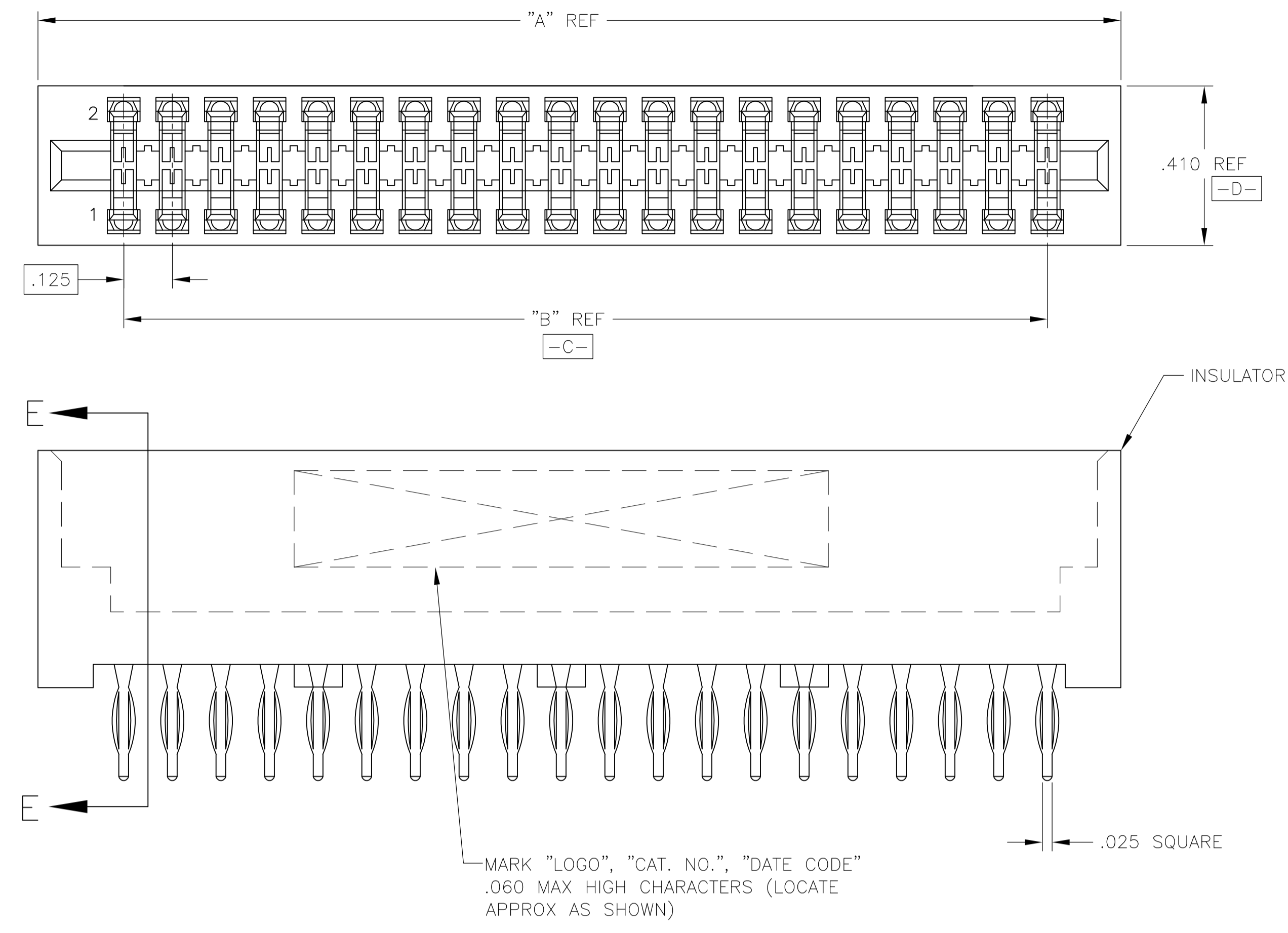
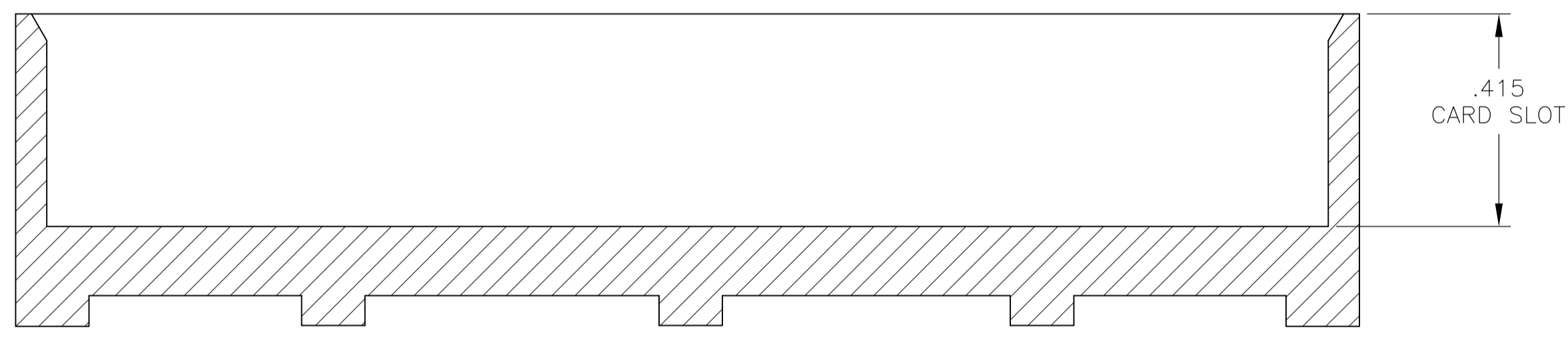

MOUNTING STYLE "04"

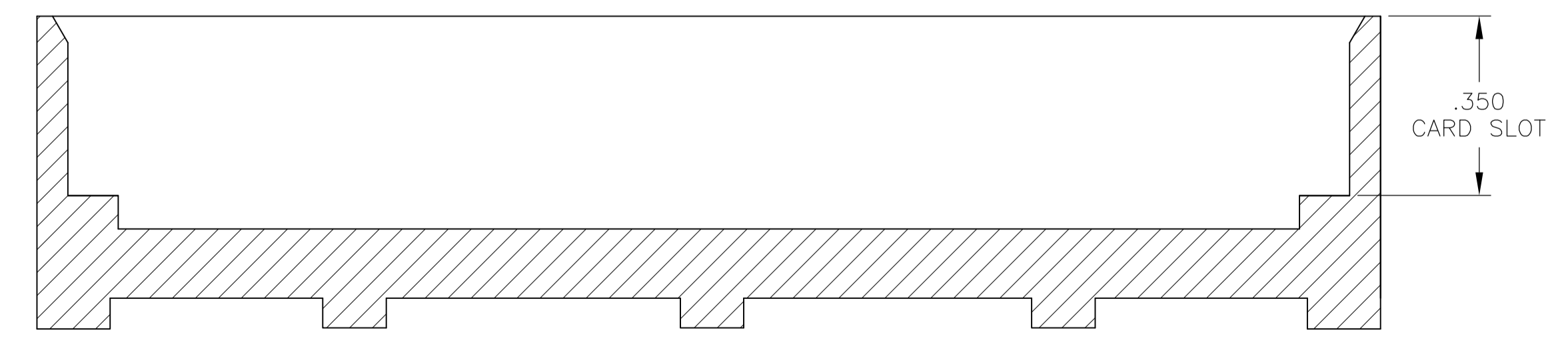

MOUNTING STYLE "13"

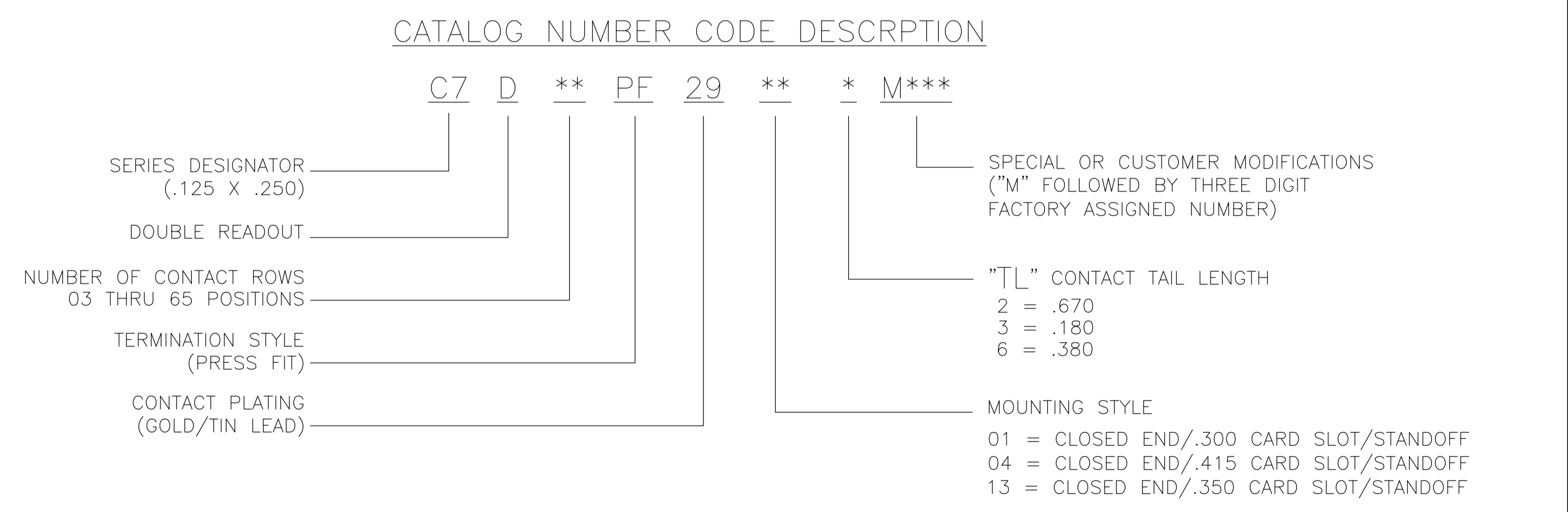

THIS DRAWING IS A CONTROLLED DOCUMENT.		DIN S SCHLEGEL 5/13/09	STE TE Connectivity	
DIMENSIONS: INCHES		CJK MILLER MICHAEL 5/13/09		
TOLERANCES UNLESS OTHERWISE SPECIFIED:		APVD MILLER MICHAEL 5/13/09	NAME: CONN ASSY, CARD EDGE, PRESS FIT (C7 SERIES, .125 X .250)	
0 PLC ± -	1 PLC ± -	PRODUCT SPEC	APPLICATION SPEC	
2 PLC ± .01	3 PLC ± .005	SIZE	CAGE CODE	DRAWING NO
4 PLC ± .0020	ANGLES ± °	WEIGHT	A1 00779	1437263-7
MATERIAL	FINISH	CUSTOMER DRAWING	SCALE	SHEET
			4:1	1 OF 3 REV A2

LOC		DIST		REVISIONS			
P	LTR	DESCRIPTION	DATE	DNW	APVD		
-	-	SEE SHEET 1	-	-	-	-	-

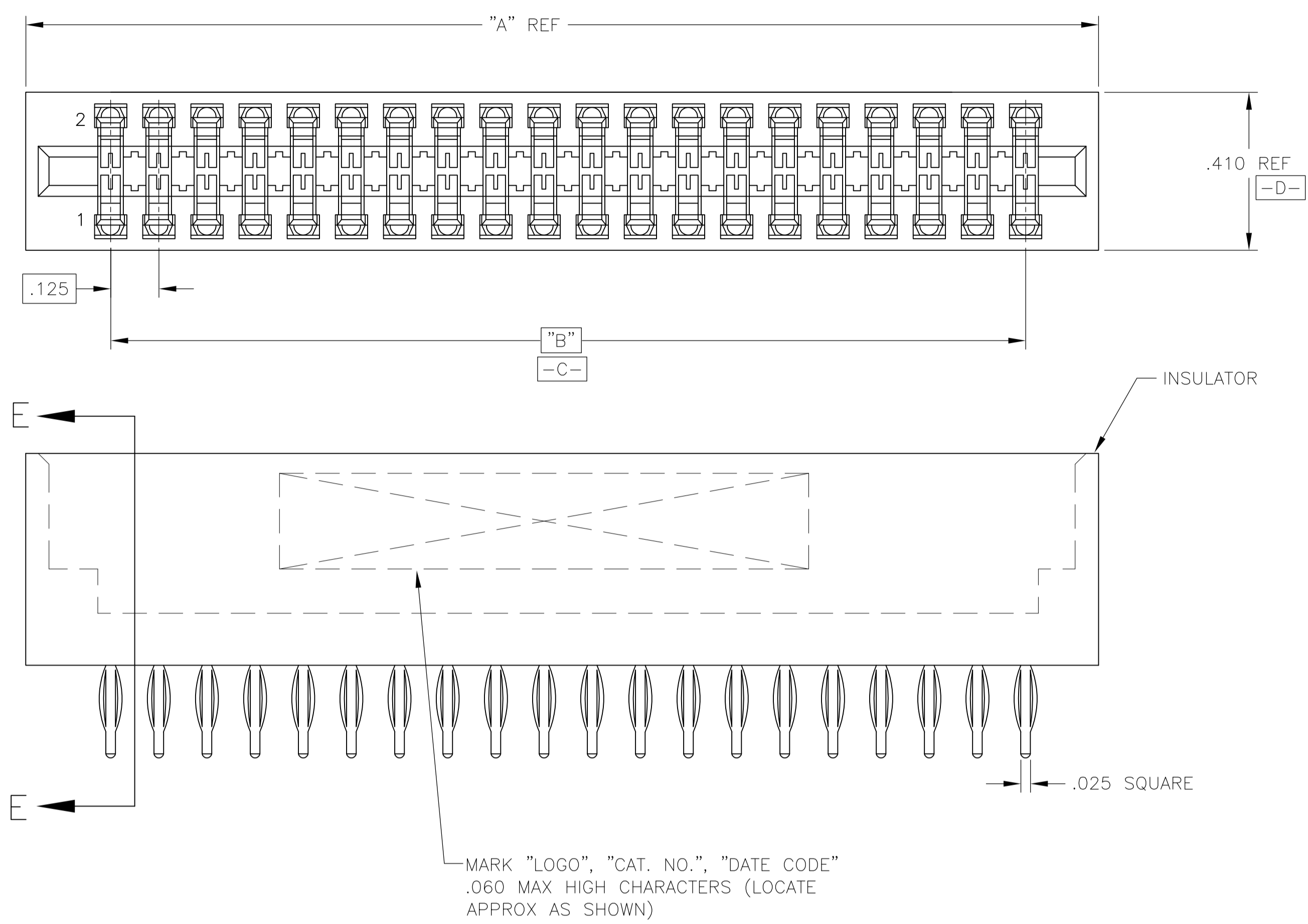

20244 D ** **
 DRAWING NUMBER
 DOUBLE READOUT
 NUMBER OF CONTACT ROWS
 03 THRU 65 POSITIONS
 MOUNTING STYLE
 02 = CLOSED END/.415 CARD SLOT/NO STANDOFF
 03 = CLOSED END/.300 CARD SLOT/NO STANDOFF
 14 = CLOSED END/.350 CARD SLOT/NO STANDOFF

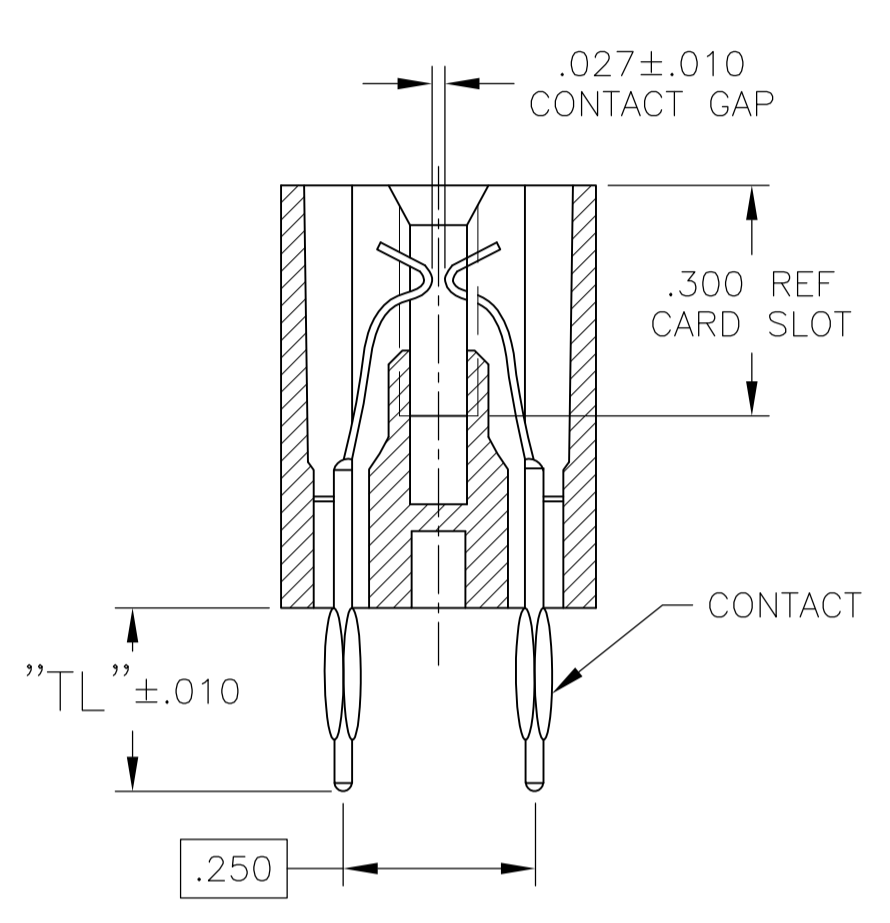

10130 29 **
 TAIL LENGTH CODE
 01 = TL3 (.180)
 03 = TL2 (.670)
 07 = TL6 (.380)
 CONTACT PLATING
 (GOLD/TIN LEAD)
 BASIC PART NUMBER

MOUNTING STYLE "03", 20 POSITION ILLUSTRATED
 (ADDITIONAL MOUNTING STYLES AS SHOWN)

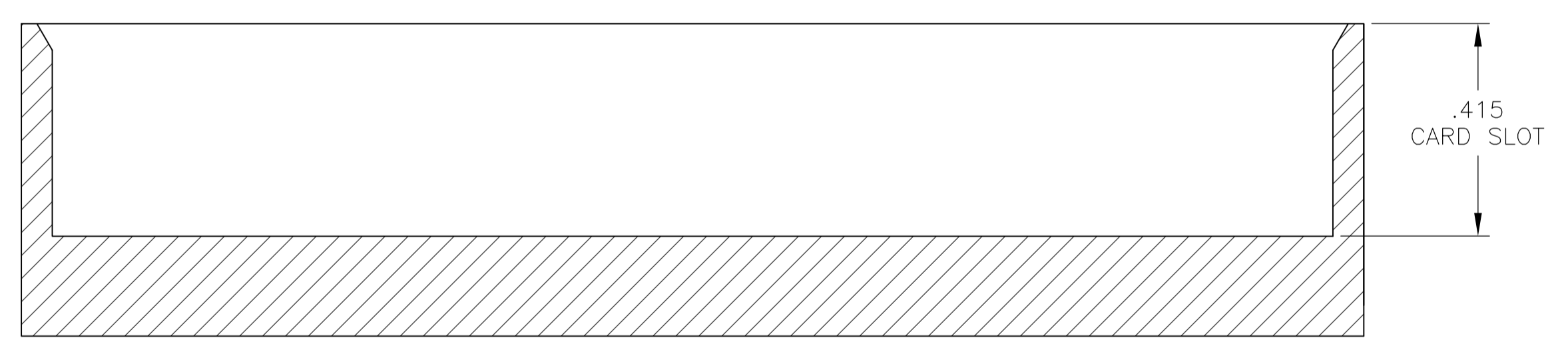

MOUNTING STYLE "02"

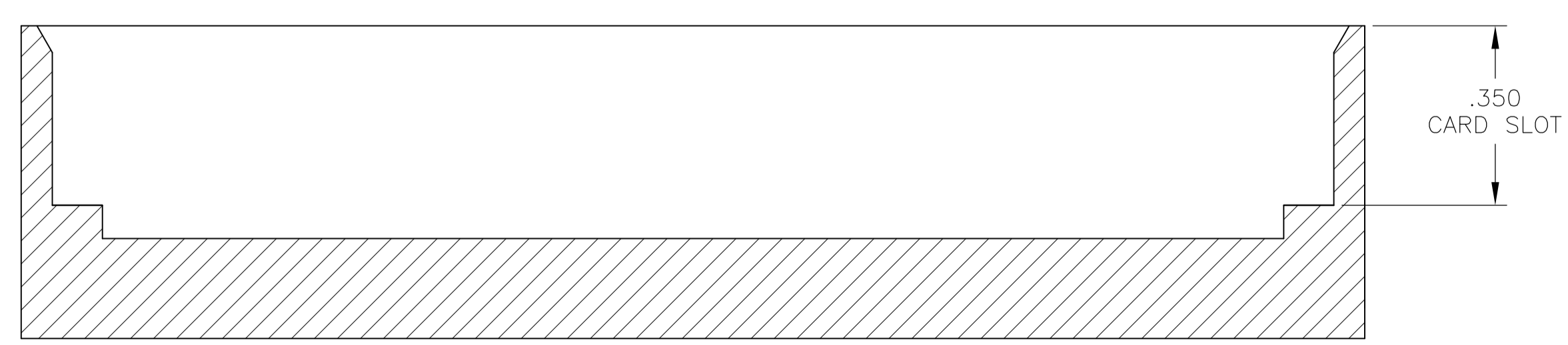

MOUNTING STYLE "14"

CATALOG NUMBER CODE DESCRIPTION
 C7 D ** PF 29 ** * M***
 SERIES DESIGNATOR (.125 X .250)
 DOUBLE READOUT
 NUMBER OF CONTACT ROWS
 03 THRU 65 POSITIONS
 TERMINATION STYLE
 (PRESS FIT)
 CONTACT PLATING
 (GOLD/TIN LEAD)
 SPECIAL OR CUSTOMER MODIFICATIONS
 ("M" FOLLOWED BY THREE DIGIT
 FACTORY ASSIGNED NUMBER)
 "TL" CONTACT TAIL LENGTH
 2 = .670
 3 = .180
 6 = .380
 MOUNTING STYLE
 02 = CLOSED END/.415 CARD SLOT/NO STANDOFF
 03 = CLOSED END/.300 CARD SLOT/NO STANDOFF
 14 = CLOSED END/.350 CARD SLOT/NO STANDOFF

THIS DRAWING IS A CONTROLLED DOCUMENT.		DNW S SCHLEGEL 5/13/09	TE Connectivity
DIMENSIONS: INCHES		CHK MILLER MICHAEL 5/13/09	
TOLERANCES UNLESS OTHERWISE SPECIFIED:		APVD MILLER MICHAEL 5/13/09	NAME
0 PLC ± -	1 PLC ± -	CONN ASSY, CARD EDGE, PRESS FIT (C7 SERIES, .125 X .250)	
2 PLC ± .01	3 PLC ± .005	PRODUCT SPEC	
4 PLC ± .0020	ANGLES ± °	APPLICATION SPEC	
MATERIAL	FINISH	SIZE	RESTRICTED TO
-	-	A1 00779	-
CUSTOMER DRAWING		SCALE 4:1	SHEET 2 OF 3 REV A2

LOC	DIST	REVISIONS			
P	LTR	DESCRIPTION	DATE	DN	APVO
-	-	SEE SHEET 1	-	-	-

65	130	8.410	8.000
64	128	8.285	7.875
63	126	8.160	7.750
62	124	8.035	7.625
61	122	7.910	7.500
60	120	7.785	7.375
59	118	7.660	7.250
58	116	7.535	7.125
57	114	7.410	7.000
56	112	7.285	6.875
55	110	7.160	6.750
54	108	7.035	6.625
53	106	6.910	6.500
52	104	6.785	6.375
51	102	6.660	6.250
50	100	6.535	6.125
49	98	6.410	6.000
48	96	6.285	5.875
47	94	6.160	5.750
46	92	6.035	5.625
45	90	5.910	5.500
44	88	5.785	5.375
43	86	5.660	5.250
42	84	5.535	5.125
41	82	5.410	5.000
40	80	5.285	4.875
39	78	5.160	4.750
38	76	5.035	4.625
37	74	4.910	4.500
36	72	4.785	4.375
35	70	4.660	4.250
NUMBER OF CONTACT ROWS	NUMBER OF CONTACTS	DIM ("A")	DIM ["B"]

34	68	4.535	4.125
33	66	4.410	4.000
32	64	4.285	3.875
31	62	4.160	3.750
30	60	4.035	3.625
29	58	3.910	3.500
28	56	3.785	3.375
27	54	3.660	3.250
26	52	3.535	3.125
25	50	3.410	3.000
24	48	3.285	2.875
23	46	3.160	2.750
22	44	3.035	2.625
21	42	2.910	2.500
20	40	2.785	2.375
19	38	2.660	2.250
18	36	2.535	2.125
17	34	2.410	2.000
16	32	2.285	1.875
15	30	2.160	1.750
14	28	2.035	1.625
13	26	1.910	1.500
12	24	1.785	1.375
11	22	1.660	1.250
10	20	1.535	1.125
09	18	1.410	1.000
08	16	1.285	.875
07	14	1.160	.750
06	12	1.035	.625
05	10	.910	.500
04	8	.785	.375
03	6	.660	.250
NUMBER OF CONTACT ROWS	NUMBER OF CONTACTS	DIM ("A")	DIM ["B"]

OBSOLETE	100	1437263-1	3-1454282-9	C7D50PF29023	6-1437263-0
	100	1437263-1	3-1454282-2	C7D50PF29143	5-1437263-7
	100	1437263-2	1437263-3	C7D43PF29013	5-1437263-2
	86	1437263-2	3-1454282-1	C7D40PF29013	5-1437263-0
	80	1437263-2	2-1454282-9	C7D40PF29043	4-1437263-8
	80	1454243-3	3-1454282-6	C7D40PF29032	4-1437263-7
	80	1437263-1	4-1454282-1	C7D40PF29023	4-1437263-6
OBSOLETE	80	1437263-2	2-1454282-8	C7D40PF29013	4-1437263-5
	80	1454243-4	2-1454282-8	C7D40PF29012	4-1437263-4
	72	1437263-1	4-1454282-0	C7D36PF29143	6-1437263-1
	72	1437263-1	2-1454282-7	C7D36PF29033	4-1437263-3
	72	1437263-2	2-1454282-6	C7D36PF29013	4-1437263-2
	72	1454243-4	2-1454282-6	C7D36PF29012	4-1437263-1
	70	1437263-2	2-1454282-5	C7D35PF29013	4-1437263-0
OBSOLETE	70	1454243-4	2-1454282-5	C7D35PF29012	3-1437263-9
	60	1454243-3	3-1454282-7	C7D30PF29032	2-1437274-7
	60	1437263-2	2-1454282-1	C7D30PF29043	3-1437263-3
	60	1437263-1	2-1454282-0	C7D30PF29023	3-1437263-2
	60	1437263-2	1-1454282-9	C7D30PF29013	3-1437263-1
	56	1454243-3	3-1454282-5	C7D28PF29032	2-1437274-3
	56	1454244-2	1-1454282-7	C7D28PF49013	3-1437263-0
	56	1437263-1	1-1454282-8	C7D28PF29023	2-1437263-9
	56	1437263-2	1-1454282-7	C7D28PF29013	2-1437263-8
	56	1454243-4	1-1454282-7	C7D28PF29012	2-1437263-7
	54	1454243-7	1-1454282-6	C7D27PF29026	2-1437263-6
	54	1454243-3	1-1454282-6	C7D27PF29022	2-1437263-5
	44	1437263-1	1-1454282-5	C7D22PF29023	2-1437263-4
	44	1437263-2	1-1454282-4	C7D22PF29013	2-1437263-3
	40	1437263-1	1-1454282-2	C7D20PF29023	2-1437263-1
	40	1437263-2	1-1454282-1	C7D20PF29013	2-1437263-0
	40	1437263-2	1-1454282-1	C7D20PF29012	1-1437263-9
	36	1437263-2	1-1454282-0	C7D18PF29043	1-1437263-8
	36	1454263-1	1454282-9	C7D18PF29023	1-1437263-7
	36	1454243-3	1454282-9	C7D18PF29022	1-1437263-6
	36	1437263-2	1454282-8	C7D18PF29013	1-1437263-5
	36	1454243-4	1454282-8	C7D18PF29012	1-1437263-4
	32	1437263-1	1454282-7	C7D16PF29043	1-1437263-3
	32	1437263-1	1454282-6	C7D16PF29023	1-1437263-2
	22	1437263-1	1454282-4	C7D11PF29023	1-1437263-0
	12	1437263-2	1454282-3	C7D06PF29053	1437263-9
	12	1437263-2	1454282-2	C7D06PF29043	1437263-8
12	1437263-1	1454282-1	C7D06PF29023	1437263-7	
QTY	CONTACT P/N	HOUSING P/N (QTY=1)	DESCRIPTION	TE PART NO	

THIS DRAWING IS A CONTROLLED DOCUMENT.

DIMENSIONS: INCHES	TOLERANCES UNLESS OTHERWISE SPECIFIED:	DIN S SCHLEGEL 5/13/09	 TE Connectivity CONN ASSY, CARD EDGE, PRESS FIT (C7 SERIES, .125 X .250)
0 PLC ± - 1 PLC ± - 2 PLC ± .01 3 PLC ± .005 4 PLC ± .0020 ANGLES ± °	APVO MILLER MICHAEL 5/13/09 CDR MILLER MICHAEL 5/13/09 PRODUCT SPEC APPLICATION SPEC	NAME SIZE CASE CODE DRAWING NO RESTRICTED TO	
MATERIAL	FINISH	WEIGHT	A1 00779 1437263-7 CUSTOMER DRAWING SCALE 1:1 SHEET 3 OF 3 REV A2

Mouser Electronics

Authorized Distributor

Click to View Pricing, Inventory, Delivery & Lifecycle Information:

[TE Connectivity:](#)

[C7D35PF29012](#)