

DS90LV027 LVDS Dual High Speed Differential Driver

Check for Samples: [DS90LV027](#)

FEATURES

- Ultra Low Power Dissipation
- Operating Range above 155 Mbps
- Flow-through pinout simplifies PCB layout
- Conforms to TIA/EIA-644 Standard
- 8-Lead SOIC Package Saves Space
- $V_{CM} \pm 1V$ center around 1.2V
- Low Differential Output Swing Typical 340 mV
- Power Off Protection (outputs in high impedance)

DESCRIPTION

The DS90LV027 is a dual LVDS driver device optimized for high data rate and low power applications. The DS90LV027 is a current mode driver allowing power dissipation to remain low even at high frequency. In addition, the short circuit fault current is also minimized. The device is in a 8-lead SOIC package. The DS90LV027 has a flow-through design for easy PCB layout. The differential driver outputs provides low EMI with its low output swings typically 340 mV. Perfect for high speed transfer of clock and data. Pair with any of TI's LVDS receivers.

Connection Diagram

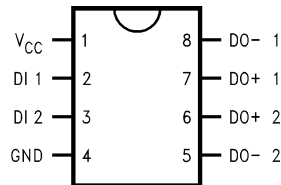
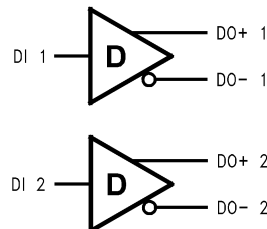

Figure 1. Dual-In-Line
See Package Number D (R-PDSO-G8)

Functional Diagram



Truth Table⁽¹⁾

Input/Output		
DI	DO+	DO-
L	L	H
H	H	L
DI > 0.8V and DI < 2.0V	X	X

- (1) H = Logic high level
L = Logic low level
X = indeterminate



Please be aware that an important notice concerning availability, standard warranty, and use in critical applications of Texas Instruments semiconductor products and disclaimers thereto appears at the end of this data sheet.

TRI-STATE is a registered trademark of Texas Instruments.
All other trademarks are the property of their respective owners.



These devices have limited built-in ESD protection. The leads should be shorted together or the device placed in conductive foam during storage or handling to prevent electrostatic damage to the MOS gates.

Absolute Maximum Ratings ⁽¹⁾

Supply Voltage (V_{CC})	-0.3V to +6V
Input Voltage (DI)	-0.3V to ($V_{CC} + 0.3V$)
Output Voltage (DO±)	-0.3V to +3.9V
Maximum Package Power Dissipation @ +25°C	
D Package	1190 mW
Derate D Package	9.5 mW/°C above +25°C
Storage Temperature Range	-65°C to +150°C
Lead Temperature Range	
Soldering (4 sec.)	+260°C
ESD Rating ⁽²⁾	
(HBM 1.5 kΩ, 100 pF)	≥ 4.5 kV

- (1) "Absolute Maximum Ratings" are those values beyond which the safety of the device cannot be ensured. They are not meant to imply that the devices should be operated at these limits. [Electrical Characteristics](#) specifies conditions of device operation.
- (2) ESD Rating: HBM (1.5 kΩ, 100 pF) ≥ 4.5 kV

Recommended Operating Conditions

	Min	Typ	Max	Units
Supply Voltage (V_{CC})	3.0	3.3	3.6	V
Temperature (T_A)	0	25	70	°C

Electrical Characteristics

Over Supply Voltage and Operating Temperature ranges, unless otherwise specified. ⁽¹⁾ ⁽²⁾ ⁽³⁾

Symbol	Parameter	Conditions	Pin	Min	Typ	Max	Units	
DIFFERENTIAL DRIVER CHARACTERISTICS								
V_{OD}	Output Differential Voltage	$R_L = 100\Omega$ (Figure 2)	DO+, DO-	250	340	450	mV	
ΔV_{OD}	V_{OD} Magnitude Change			0	10	35	mV	
V_{OH}	Output High Voltage				1.43	1.6	V	
V_{OL}	Output Low Voltage				0.9	1.09	V	
V_{OS}	Offset Voltage				0.9	1.25	1.6	V
ΔV_{OS}	Offset Magnitude Change				0	5	25	mV
I_{OZD}	TRI-STATE [®] Leakage	$V_{OUT} = V_{CC}$ or GND		0	±1	±10	μA	
I_{OXD}	Power-off Leakage	$V_{OUT} = 3.6V$ or GND, $V_{CC} = 0V$		0	±1	±10	μA	
I_{OSD}	Output Short Circuit Current				-4	-6	mA	
V_{IH}	Input High Voltage		DI	2.0		V_{CC}	V	
V_{IL}	Input Low Voltage			GND			0.8	V
I_{IH}	Input High Current	$V_{IN} = 3.6V$ or 2.4V			±1	±10	μA	
I_{IL}	Input Low Current	$V_{IN} = GND$ or 0.5V			±1	±10	μA	
V_{CL}	Input Clamp Voltage	$I_{CL} = -18$ mA		-1.5	-0.8		V	
I_{CC}	Power Supply Current	No Load	$V_{IN} = V_{CC}$ or GND	V_{CC}		1	4	mA
		$R_L = 100\Omega$				8	11	mA

- (1) Current into device pins is defined as positive. Current out of device pins is defined as negative. All voltages are referenced to ground except V_{OD} .
- (2) All typicals are given for: $V_{CC} = +3.3V$ and $T_A = +25^\circ C$.
- (3) The DS90LV027 is a current mode device and only function with datasheet specification when a resistive load is applied to the drivers outputs.

Switching Characteristics

Over Supply Voltage and Operating Temperature Ranges, unless otherwise specified. ⁽¹⁾ ⁽²⁾

Symbol	Parameter	Conditions	Min	Typ	Max	Units
DIFFERENTIAL DRIVER CHARACTERISTICS						
t_{PHLD}	Differential Propagation Delay High to Low	$R_L = 100\Omega$, $C_L = 5\text{ pF}$ (Figure 3 and Figure 4)	1.5	3.4	6	ns
t_{PLHD}	Differential Propagation Delay Low to High		1.5	3.5	6	ns
t_{SKD}	Differential Skew $ t_{PHLD} - t_{PLHD} $		0	0.1	1.9	ns
t_{TLH}	Transition Low to High Time		0	1	3	ns
t_{THL}	Transition High to Low Time		0	1	3	ns

(1) C_L includes probe and fixture capacitance.

(2) Generator waveform for all tests unless otherwise specified: $f = 1\text{ MHz}$, $Z_0 = 50\Omega$, $t_r \leq 6\text{ ns}$, $t_f \leq 6\text{ ns}$ (10%-90%).

PARAMETER MEASUREMENT INFORMATION

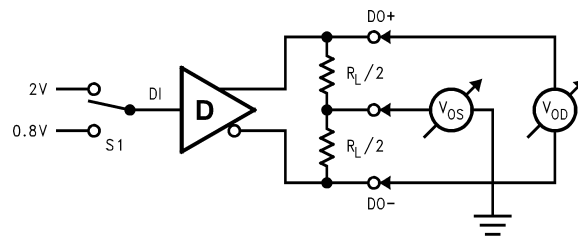

Figure 2. Differential Driver DC Test Circuit

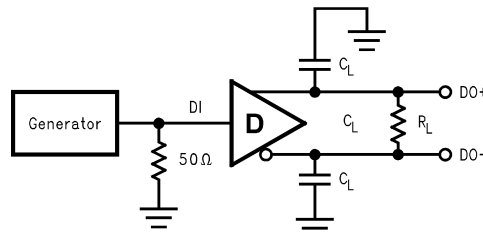

Figure 3. Differential Driver Propagation Delay and Transition Time Test Circuit

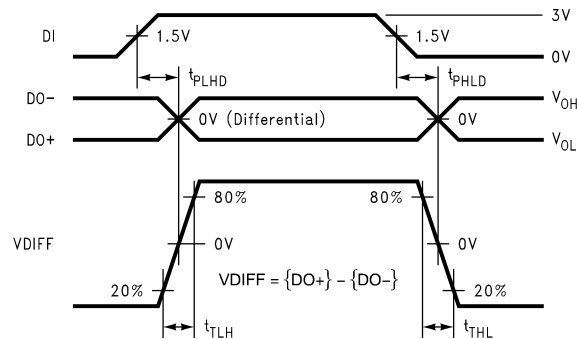

Figure 4. Differential Driver Propagation Delay and Transition Time Waveforms



APPLICATION INFORMATION**Table 1. Device Pin Descriptions**

Pin #	Name	Description
2, 3	DI	TTL/CMOS driver input pins
6, 7	DO+	Non-inverting driver output pin
5, 8	DO-	Inverting driver output pin
4	GND	Ground pin
1	V _{CC}	Positive power supply pin, +3.3V ± 0.3V

REVISION HISTORY

Changes from Revision B (April 2013) to Revision C	Page
<hr/> <ul style="list-style-type: none">• Changed layout of National Data Sheet to TI format	<hr/> 4

PACKAGING INFORMATION

Orderable Device	Status (1)	Package Type	Package Drawing	Pins	Package Qty	Eco Plan (2)	Lead/Ball Finish (6)	MSL Peak Temp (3)	Op Temp (°C)	Device Marking (4/5)	Samples
DS90LV027M/NOPB	ACTIVE	SOIC	D	8	95	Green (RoHS & no Sb/Br)	SN	Level-1-260C-UNLIM	0 to 70	90LV 027M	
DS90LV027MX/NOPB	ACTIVE	SOIC	D	8	2500	Green (RoHS & no Sb/Br)	SN	Level-1-260C-UNLIM	0 to 70	90LV 027M	

(1) The marketing status values are defined as follows:

ACTIVE: Product device recommended for new designs.

LIFEBUY: TI has announced that the device will be discontinued, and a lifetime-buy period is in effect.

NRND: Not recommended for new designs. Device is in production to support existing customers, but TI does not recommend using this part in a new design.

PREVIEW: Device has been announced but is not in production. Samples may or may not be available.

OBSELETE: TI has discontinued the production of the device.

(2) **RoHS:** TI defines "RoHS" to mean semiconductor products that are compliant with the current EU RoHS requirements for all 10 RoHS substances, including the requirement that RoHS substance do not exceed 0.1% by weight in homogeneous materials. Where designed to be soldered at high temperatures, "RoHS" products are suitable for use in specified lead-free processes. TI may reference these types of products as "Pb-Free".

RoHS Exempt: TI defines "RoHS Exempt" to mean products that contain lead but are compliant with EU RoHS pursuant to a specific EU RoHS exemption.

Green: TI defines "Green" to mean the content of Chlorine (Cl) and Bromine (Br) based flame retardants meet JS709B low halogen requirements of <=1000ppm threshold. Antimony trioxide based flame retardants must also meet the <=1000ppm threshold requirement.

(3) MSL, Peak Temp. - The Moisture Sensitivity Level rating according to the JEDEC industry standard classifications, and peak solder temperature.

(4) There may be additional marking, which relates to the logo, the lot trace code information, or the environmental category on the device.

(5) Multiple Device Markings will be inside parentheses. Only one Device Marking contained in parentheses and separated by a "~" will appear on a device. If a line is indented then it is a continuation of the previous line and the two combined represent the entire Device Marking for that device.

(6) Lead/Ball Finish - Orderable Devices may have multiple material finish options. Finish options are separated by a vertical ruled line. Lead/Ball Finish values may wrap to two lines if the finish value exceeds the maximum column width.

Important Information and Disclaimer:The information provided on this page represents TI's knowledge and belief as of the date that it is provided. TI bases its knowledge and belief on information provided by third parties, and makes no representation or warranty as to the accuracy of such information. Efforts are underway to better integrate information from third parties. TI has taken and continues to take reasonable steps to provide representative and accurate information but may not have conducted destructive testing or chemical analysis on incoming materials and chemicals. TI and TI suppliers consider certain information to be proprietary, and thus CAS numbers and other limited information may not be available for release.

In no event shall TI's liability arising out of such information exceed the total purchase price of the TI part(s) at issue in this document sold by TI to Customer on an annual basis.

TAPE AND REEL INFORMATION

QUADRANT ASSIGNMENTS FOR PIN 1 ORIENTATION IN TAPE

*All dimensions are nominal

Device	Package Type	Package Drawing	Pins	SPQ	Reel Diameter (mm)	Reel Width W1 (mm)	A0 (mm)	B0 (mm)	K0 (mm)	P1 (mm)	W (mm)	Pin1 Quadrant
DS90LV027MX/NOPB	SOIC	D	8	2500	330.0	12.4	6.5	5.4	2.0	8.0	12.0	Q1

TAPE AND REEL BOX DIMENSIONS



*All dimensions are nominal

Device	Package Type	Package Drawing	Pins	SPQ	Length (mm)	Width (mm)	Height (mm)
DS90LV027MX/NOPB	SOIC	D	8	2500	367.0	367.0	35.0



D0008A

PACKAGE OUTLINE

SOIC - 1.75 mm max height

SMALL OUTLINE INTEGRATED CIRCUIT



4214825/C 02/2019

NOTES:

- Linear dimensions are in inches [millimeters]. Dimensions in parenthesis are for reference only. Controlling dimensions are in inches. Dimensioning and tolerancing per ASME Y14.5M.
- This drawing is subject to change without notice.
- This dimension does not include mold flash, protrusions, or gate burrs. Mold flash, protrusions, or gate burrs shall not exceed .006 [0.15] per side.
- This dimension does not include interlead flash.
- Reference JEDEC registration MS-012, variation AA.

EXAMPLE BOARD LAYOUT

D0008A

SOIC - 1.75 mm max height

SMALL OUTLINE INTEGRATED CIRCUIT



LAND PATTERN EXAMPLE
EXPOSED METAL SHOWN
SCALE:8X



SOLDER MASK DETAILS

4214825/C 02/2019

NOTES: (continued)

6. Publication IPC-7351 may have alternate designs.

7. Solder mask tolerances between and around signal pads can vary based on board fabrication site.

EXAMPLE STENCIL DESIGN

D0008A

SOIC - 1.75 mm max height

SMALL OUTLINE INTEGRATED CIRCUIT



SOLDER PASTE EXAMPLE
BASED ON .005 INCH [0.125 MM] THICK STENCIL
SCALE:8X

4214825/C 02/2019

NOTES: (continued)

8. Laser cutting apertures with trapezoidal walls and rounded corners may offer better paste release. IPC-7525 may have alternate design recommendations.
9. Board assembly site may have different recommendations for stencil design.

IMPORTANT NOTICE AND DISCLAIMER

TI PROVIDES TECHNICAL AND RELIABILITY DATA (INCLUDING DATASHEETS), DESIGN RESOURCES (INCLUDING REFERENCE DESIGNS), APPLICATION OR OTHER DESIGN ADVICE, WEB TOOLS, SAFETY INFORMATION, AND OTHER RESOURCES "AS IS" AND WITH ALL FAULTS, AND DISCLAIMS ALL WARRANTIES, EXPRESS AND IMPLIED, INCLUDING WITHOUT LIMITATION ANY IMPLIED WARRANTIES OF MERCHANTABILITY, FITNESS FOR A PARTICULAR PURPOSE OR NON-INFRINGEMENT OF THIRD PARTY INTELLECTUAL PROPERTY RIGHTS.

These resources are intended for skilled developers designing with TI products. You are solely responsible for (1) selecting the appropriate TI products for your application, (2) designing, validating and testing your application, and (3) ensuring your application meets applicable standards, and any other safety, security, or other requirements. These resources are subject to change without notice. TI grants you permission to use these resources only for development of an application that uses the TI products described in the resource. Other reproduction and display of these resources is prohibited. No license is granted to any other TI intellectual property right or to any third party intellectual property right. TI disclaims responsibility for, and you will fully indemnify TI and its representatives against, any claims, damages, costs, losses, and liabilities arising out of your use of these resources.

TI's products are provided subject to TI's Terms of Sale (www.ti.com/legal/termsofsale.html) or other applicable terms available either on ti.com or provided in conjunction with such TI products. TI's provision of these resources does not expand or otherwise alter TI's applicable warranties or warranty disclaimers for TI products.

Mailing Address: Texas Instruments, Post Office Box 655303, Dallas, Texas 75265
Copyright © 2020, Texas Instruments Incorporated