

Ultra subminiature Toggle Switch

A9TS

Ultra subminiature size.

- Gold-plated clip contact ensure high reliability.
- The sealed bottom prevents flux penetration.
- Washable, equivalent to IP64 (IEC-60529).
- A9TS is smaller than A9T.
Height: A9T 17mm A9TS 11mm (35% smaller than A9T)

RoHS Compliant

Typical Applications

Security Control Boards
Electric Power Instrumentation
Program Controllers

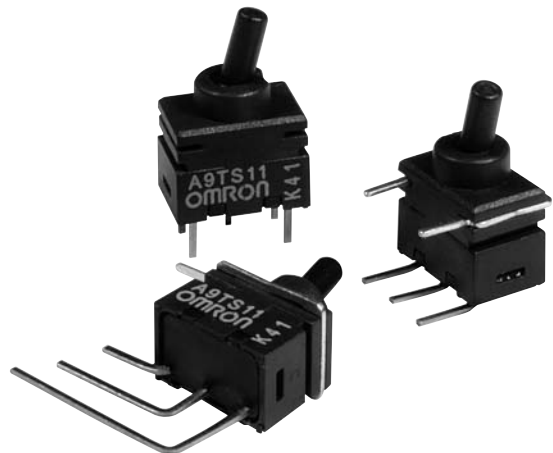

List of Models

Actuator Shape Terminal Shape			Standard					
			DIP Terminal		Right Angle Terminal		Vertical Mount Terminal	
ON	–	ON	A9TS11-0011	A9TS21-0011	A9TS11-0012	A9TS21-0012	A9TS11-0013	A9TS21-0013
ON	OFF	ON	A9TS12-0011	A9TS22-0011	A9TS12-0012	A9TS22-0012	A9TS12-0013	A9TS22-0013
Quantity per tray			100		25		50	

Note: 1. Lever do not stop at "-" position.

2. Switching Functions show the view from the side of Type and Brand name marking.

Ratings/Characteristics

Rating (resistive load)	14 mA at 28 VAC/DC, 0.1 μA (minimum current) at 20 mVAC/DC	
Ambient operating temperature	-20 °C to +80 °C 60% RH max. (with no icing or condensation)	
Ambient operating humidity	45 to 85% RH (at +5 to +35 °C)	
Insulation resistance	500 MΩ min. (at 500 VDC with insulation tester)	
Contact resistance (initial value)	80 mΩ max.	
Dielectric strength	500 VAC for 1min between terminals, between terminals and ground	
Vibration resistance	Malfunction	10 to 55 Hz, 1.5-mm double amplitude
Shock resistance	Malfunction	500 m/s ² min.
Durability	Mechanical	50,000 operations min.
	Electrical	50,000 operations min.
Degree of protection	IEC IP64	
Washing	Possible	
Operating force	4.9 N max.	
Weight	0.3 g	

■ Dimensions (Unit: mm)

● DIP Terminal Models

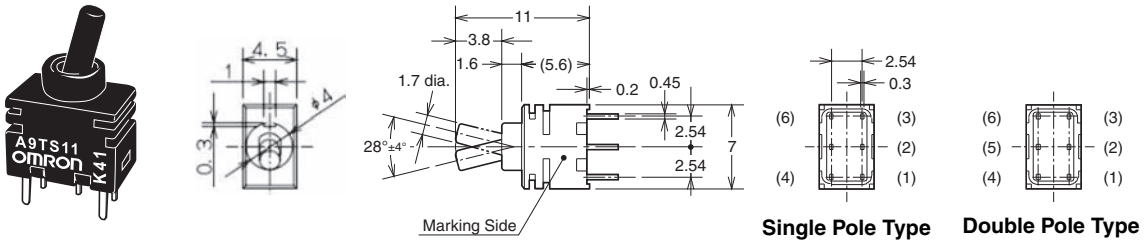

Note: NO.(4) and (6) terminals in the SPDT models are dummies to support the Switch case.

● Right Angle Terminal Models

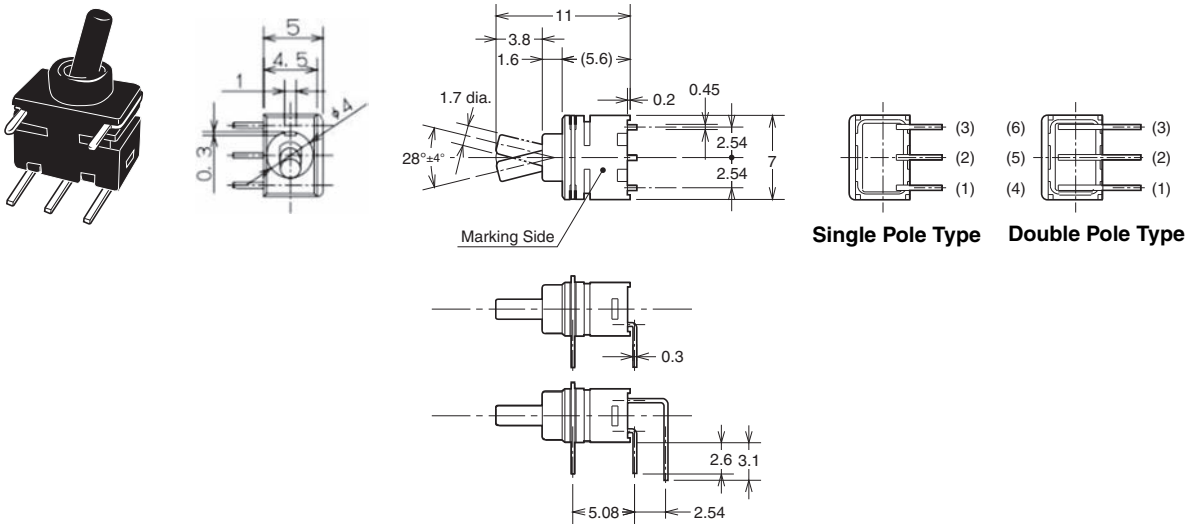

● Vertical Mount Terminal Models

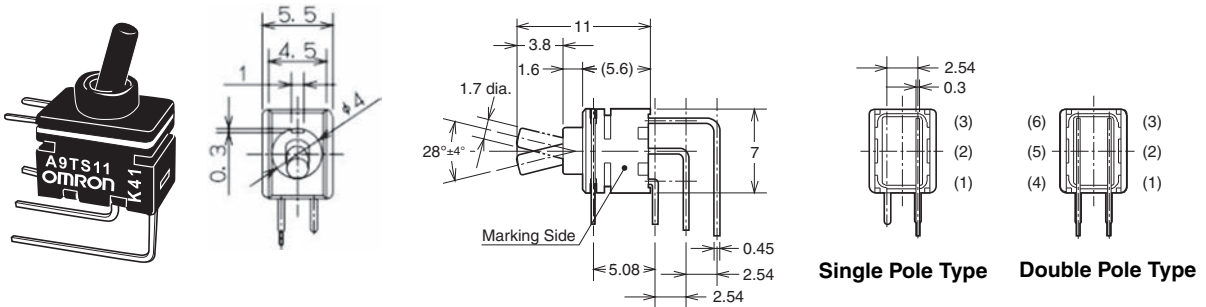

Note: Unless otherwise specified, a tolerance of ± 0.4 mm applies to all dimensions.

■ PCB Dimensions (Top View)

DIP Terminal Models

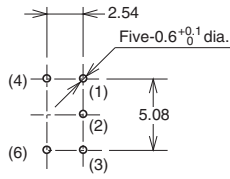

Single Pole Type

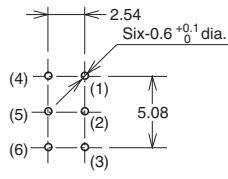

Double Pole Type

Right Angle Terminal Models

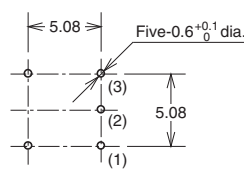

Single Pole Type

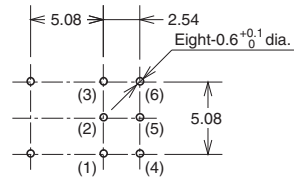

Double Pole Type

Vertical Mount Terminal Models

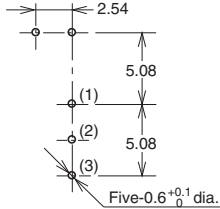



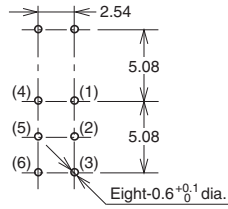

Single Pole Type

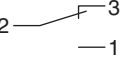
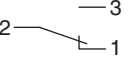
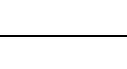
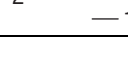
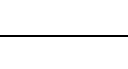
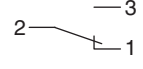
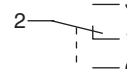
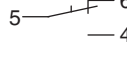
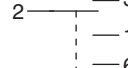
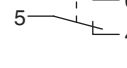

Double Pole Type

■ Switching Function / Internal Connections

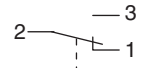
	Switching Functions					
	ON	-	ON			
SPDT Models	ON	-	ON			
	ON	OFF	ON			
DPDT Models	ON	-	ON			
	ON	OFF	ON			

Note: Lever do not stop at "-" position.

■ Safety Precautions

Be sure to read the Safety precautions common to all PCB-mount Manual Switch for correct use.

● Cautions

Use the switch within the rated voltage and current ranges, otherwise the Switch may have a shortened life expectancy, radiate heat, or burn out. This particularly applies to the instantaneous voltages and currents when switching.

● Handling

Do not apply excessive operating force to the Switch. Otherwise the Switch may be damaged or deformed, and the switch mechanism may malfunction as a result. Apply an operating force not exceeding 9.8N {1,000gf}. Apply the operating load from the top of the actuator. Do not apply a load from angle or from side the actuator. Doing so may deform the Switch contact.

● Soldering

Observe the following conditions when soldering the Switch.

Automatic Soldering Bath

Soldering temperature: 260 °C max. (Preheating: 100 °C 120s max.)

Soldering time: 5s max.

Manual Soldering

Soldering temperature: 350 °C at the tip of the soldering iron.

Soldering time: 3s max.

● Washing

Apply alcohol based solvents to clean.

Do not clean the Switch immediately after soldering. Wait for at least five minutes after soldering before cleaning.

Ultrasonic cleaning is not available dip into Switch washing agents for two minutes maximum.

● Using Flux

Making mistakes in the type of flux or in the amount or method in which it is applied can cause flux to enter the interior of the Switch, with adverse effects on Switch performance. Assess the proper flux, conditions, and methods prior to using it.

● RoHS Compliant

The "RoHS Compliant" designation indicates that the listed models do not contain the six hazardous substances covered by the RoHS Directive.

Reference: The following standards are used to determine compliance for the six substances.

- Lead: 1,000 ppm max.
- Mercury: 1,000 ppm max.
- Cadmium: 100 ppm max.
- Hexavalent chromium: 1,000 ppm max.
- PBB: 1,000 ppm max.
- PBDF: 1,000 ppm max.

● Environment for Storage and Use

To prevent discoloration of the terminals and other problems during storage, do not store the Switch in locations subject to the following conditions.

1. High temperature or humidity
2. Corrosive gases
3. Direct sunlight

Also, the Switch is not waterproof or splash-resistance.

Do not use the Switch in locations that are subject to contact with water. Do not subject the Switch to freezing or condensation.

• Application examples provided in this document are for reference only. In actual applications, confirm equipment functions and safety before using the product.
• Consult your OMRON representative before using the product under conditions which are not described in the manual or applying the product to nuclear control systems, railroad systems, aviation systems, vehicles, combustion systems, medical equipment, amusement machines, safety equipment, and other systems or equipment that may have a serious influence on lives and property if used improperly. Make sure that the ratings and performance characteristics of the product provide a margin of safety for the system or equipment, and be sure to provide the system or equipment with double safety mechanisms.

Note: Do not use this document to operate the Unit.

Mouser Electronics

Authorized Distributor

Click to View Pricing, Inventory, Delivery & Lifecycle Information:

[Omron:](#)

[A9TS12-0013](#) [A9TS11-0011](#) [A9TS11-0013](#) [A9TS12-0011](#) [A9TS12-0012](#) [A9TS21-0012](#) [A9TS21-0013](#) [A9TS22-0011](#) [A9TS22-0012](#) [A9TS22-0013](#) [A9TS21-0011](#) [A9TS11-0012](#)