

PROTECTION PRODUCTS - MicroClamp™

Description

The μ Clamp™ series of TVS arrays are designed to protect sensitive electronics from damage or latch-up due to ESD. It is designed to replace multilayer varistors (MLVs) in portable applications such as cell phones, notebook computers, and other portable electronics. It features large cross-sectional area junctions for conducting high transient currents. They offer desirable characteristics for board level protection including fast response time, low operating and clamping voltage, and no device degradation.

The μ Clamp™0501T is in a 2-pin, RoHS/WEEE compliant, SLP1006P2T package. It measures 1.0 x 0.6 mm with a nominal height of only 0.4mm. The leads are spaced at a pitch of 0.65mm and are finished with lead-free NiPdAu. Each device will protect one line operating at 5 volts. It gives the designer the flexibility to protect single lines in applications where arrays are not practical. They may be used to meet the ESD immunity requirements of IEC 61000-4-2, Level 4 (± 15 kV air, ± 8 kV contact discharge). The combination of small size and high ESD surge capability makes them ideal for use in portable applications such as cellular phones, digital cameras, and MP3 players.

Features

- ◆ Transient protection for data lines to **IEC 61000-4-2 (ESD) ± 15 kV (air), ± 8 kV (contact)**
IEC 61000-4-4 (EFT) 40A (tp = 5/50ns)
Cable Discharge Event (CDE)
- ◆ Ultra-small package (1.0 x 0.6 x 0.4mm)
- ◆ Protects one data line
- ◆ Low clamping voltage
- ◆ Working voltage: 5V
- ◆ Low leakage current
- ◆ Solid-state silicon-avalanche technology

Mechanical Characteristics

- ◆ SLP1006P2T package
- ◆ RoHS/WEEE Compliant
- ◆ Nominal Dimensions: 1.0 x 0.6 x 0.4 mm
- ◆ Lead Finish: NiPdAu
- ◆ Molding compound flammability rating: UL 94V-0
- ◆ Marking : Marking code, cathode band
- ◆ Packaging : Tape and Reel

Applications

- ◆ Cellular Handsets & Accessories
- ◆ Personal Digital Assistants (PDAs)
- ◆ Notebooks & Handhelds
- ◆ Portable Instrumentation
- ◆ Digital Cameras
- ◆ Peripherals
- ◆ MP3 Players

Dimensions

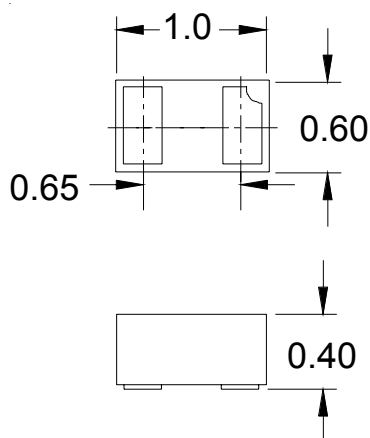

Nominal Dimensions (mm)

Schematic & PIN Configuration

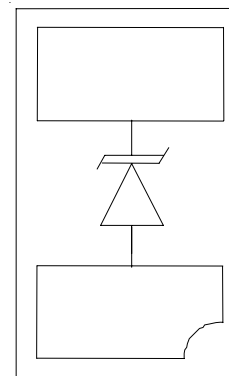

SLP1006P2T (Bottom View)

PROTECTION PRODUCTS
Absolute Maximum Rating

Rating	Symbol	Value	Units
Peak Pulse Power ($t_p = 8/20\mu s$)	P_{pk}	25	Watts
Maximum Peak Pulse Current ($t_p = 8/20\mu s$)	I_{pp}	2	Amps
ESD per IEC 61000-4-2 (Air) ESD per IEC 61000-4-2 (Contact)	V_{ESD}	+/- 20 +/- 15	kV
Operating Temperature	T_J	-55 to +125	°C
Storage Temperature	T_{STG}	-55 to +150	°C

Electrical Characteristics (T=25°C)

Parameter	Symbol	Conditions	Minimum	Typical	Maximum	Units
Reverse Stand-Off Voltage	V_{RWM}				5	V
Reverse Breakdown Voltage	V_{BR}	$I_t = 1mA$	6			V
Reverse Leakage Current	I_R	$V_{RWM} = 5V, T=25^\circ C$			0.25	μA
Forward Voltage	V_F	$I_F = 10mA$		1	1.2	V
Clamping Voltage	V_C	$I_{pp} = 2A, t_p = 8/20\mu s$			12.5	V
Junction Capacitance	C_j	$V_R = 0V, f = 1MHz$			10	pF
Junction Capacitance	C_j	$V_R = 3.3V, f = 1MHz$		4.5		pF

PROTECTION PRODUCTS

Typical Characteristics

Non-Repetitive Peak Pulse Power vs. Pulse Time

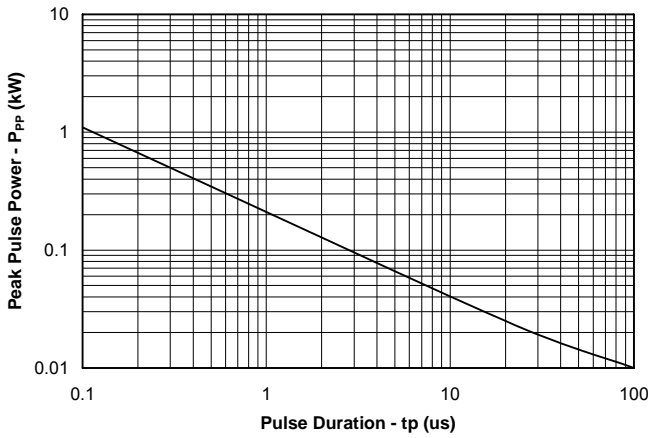

Power Derating Curve

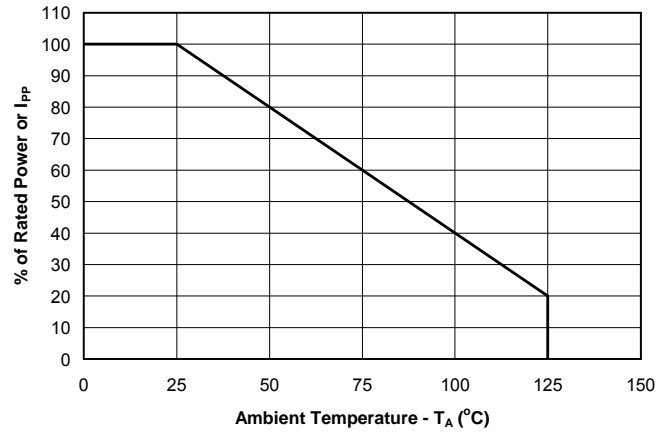

Clamping Voltage vs. Peak Pulse Current

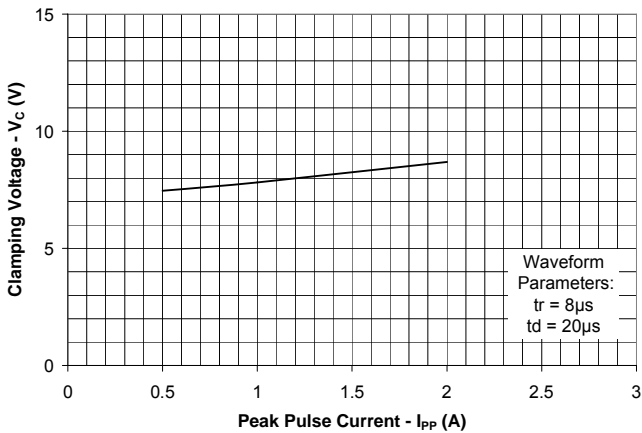

Forward Voltage vs. Forward Current

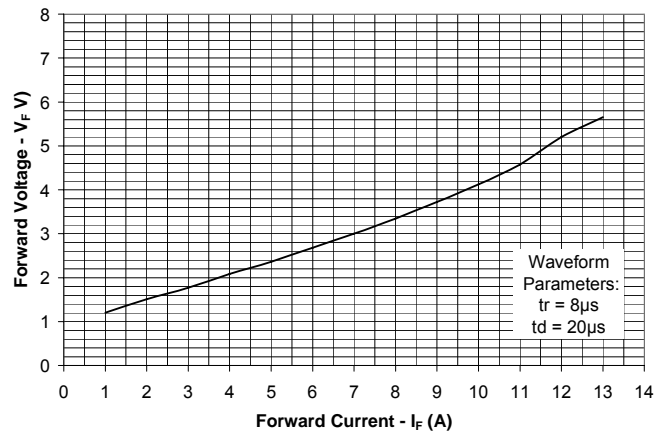

Junction Capacitance vs. Reverse Voltage

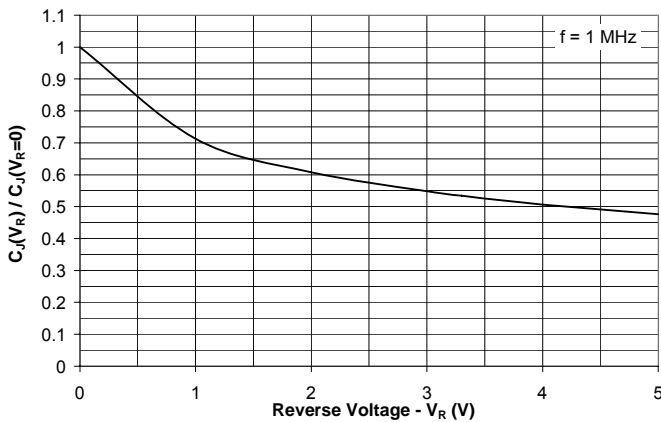

ESD Clamping
(8kV Contact per IEC 61000-4-2)

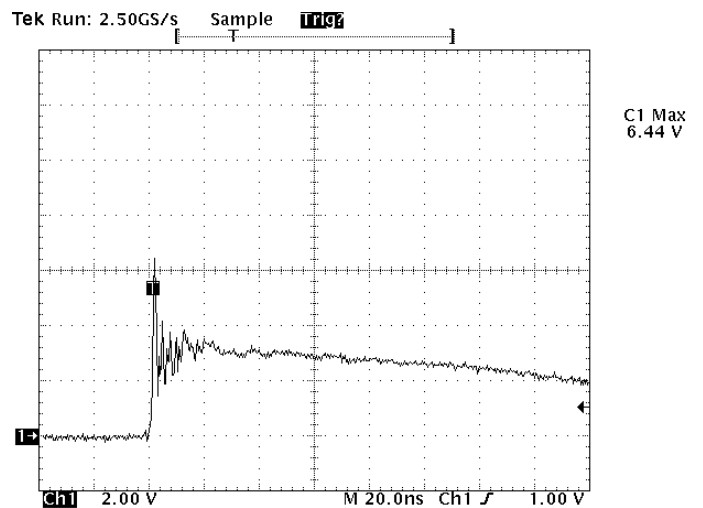

Note: Data is taken with a 10x attenuator

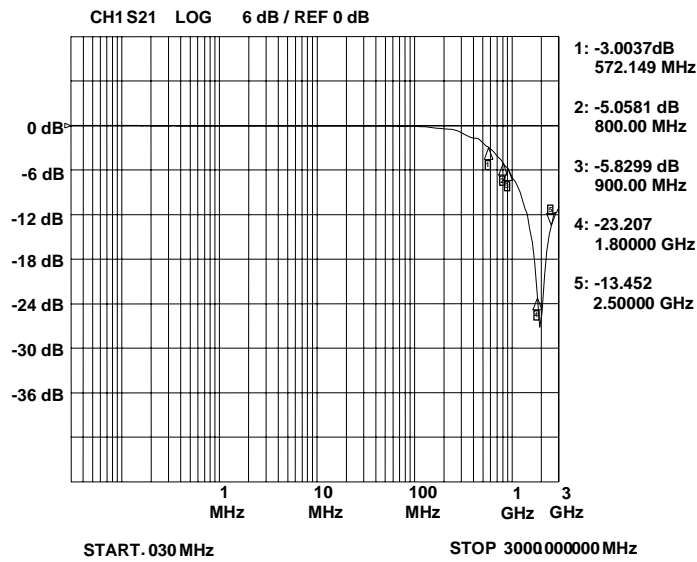
PROTECTION PRODUCTS
Typical Characteristics
Insertion Loss S21

PROTECTION PRODUCTS**Applications Information****Device Connection Options**

This device is designed to protect one data or power supply line. The device is unidirectional and may be used on lines where the signal polarity is above ground. The cathode band should be placed towards the line that is to be protected.

Circuit Board Layout Recommendations for Suppression of ESD.

Good circuit board layout is critical for the suppression of ESD induced transients. The following guidelines are recommended:

- Place the TVS near the input terminals or connectors to restrict transient coupling.
- Minimize the path length between the TVS and the protected line.
- Minimize all conductive loops including power and ground loops.
- The ESD transient return path to ground should be kept as short as possible.
- Never run critical signals near board edges.
- Use ground planes whenever possible.

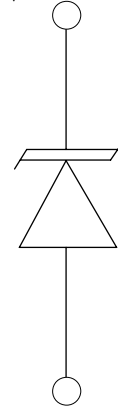
Circuit Diagram

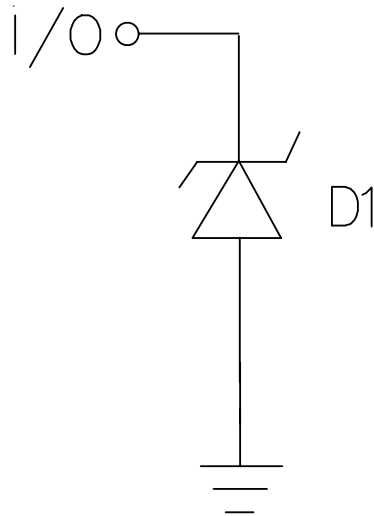
PROTECTION PRODUCTS
Applications Information - Spice Model

uClamp0501T Spice Model

uClamp0501T Spice Parameters		
Parameter	Unit	D1 (TVS)
IS	Amp	2.05e-15
BV	Volt	7.0
VJ	Volt	0.80
RS	Ohm	0.75
IBV	Amp	1.0E-3
CJO	Farad	9e-12
TT	sec	2.541E-9
M	--	0.25
N	--	1.1
EG	eV	1.11

PROTECTION PRODUCTS

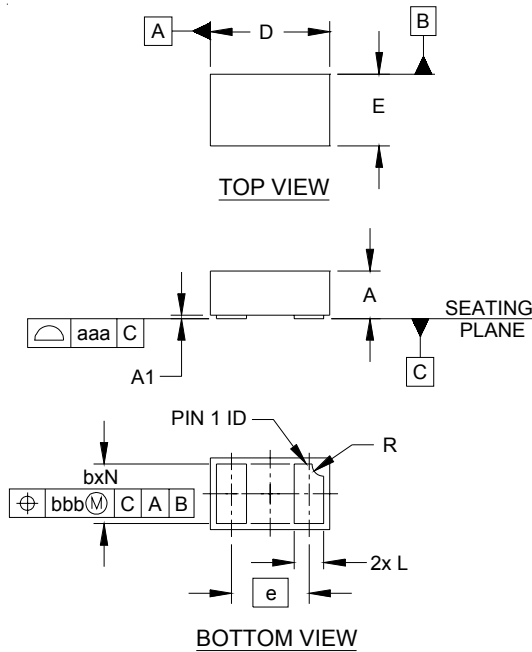
Outline Drawing - SLP1006P2T



DIM	DIMENSIONS					
	INCHES			MILLIMETERS		
	MIN	NOM	MAX	MIN	NOM	MAX
A	.015	.016	.017	0.37	0.40	0.43
A1	.000	.001	.002	0.00	0.03	0.05
b	.018	.020	.022	0.45	0.50	0.55
D	.035	.039	.043	0.90	1.00	1.10
E	.020	.024	.028	0.50	0.60	0.70
e	.026 BSC			0.65 BSC		
L	.008	.010	.012	0.20	0.25	0.30
R	.002	.004	.006	0.05	0.10	0.15
N	2			2		
aaa	.003			0.08		
bbb	.004			0.10		

NOTES:

1. CONTROLLING DIMENSIONS ARE IN MILLIMETERS (ANGLES IN DEGREES).

Land Pattern - SLP1006P2T

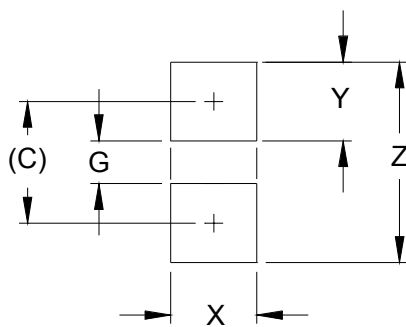

DIM	DIMENSIONS	
	INCHES	MILLIMETERS
C	(.033)	(0.85)
G	.012	0.30
X	.024	0.60
Y	.022	0.55
Z	.055	1.40

NOTES:

1. CONTROLLING DIMENSIONS ARE IN MILLIMETERS (ANGLES IN DEGREES).
2. THIS LAND PATTERN IS FOR REFERENCE PURPOSES ONLY.
CONSULT YOUR MANUFACTURING GROUP TO ENSURE YOUR COMPANY'S MANUFACTURING GUIDELINES ARE MET.

PROTECTION PRODUCTS

Marking Code

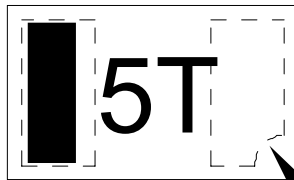

PIN 1 ID

Ordering Information

Part Number	Working Voltage	Qty per Reel	Reel Size
uClamp0501T.TCT	5V	3,000	7 Inch

Notes:

1) This is a lead-free, RoHS/WEEE compliant product
MicroClamp, uClamp and μ Clamp are marks of Semtech Corporation

Tape and Reel Specification

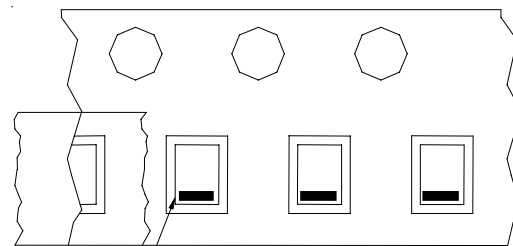
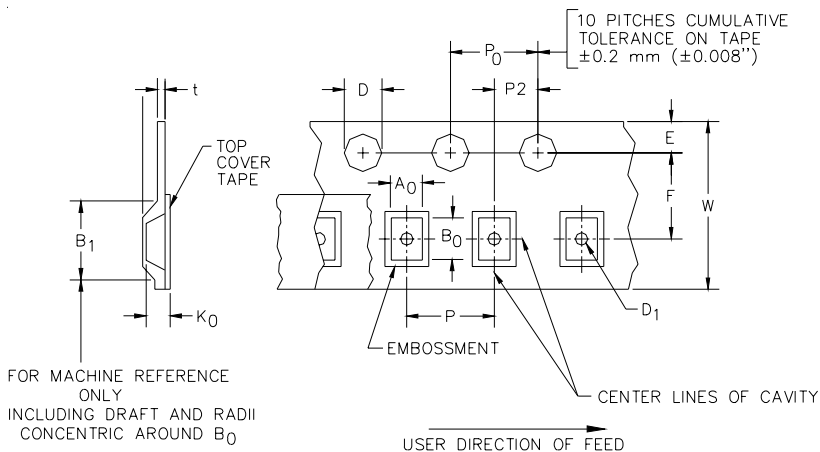

Cathode Bar

User Direction of feed

Device Orientation in Tape

A0	B0	K0
0.69 +/-0.10 mm	1.19 +/-0.10 mm	0.66 +/-0.10 mm

Tape Width	B, (Max)	D	D1	E	F	P	P0	P2	T	W
8 mm	4.2 mm (.165)	1.5 + 0.1 mm - 0.0 mm (0.59 +.005 -.000)	0.4 mm ±0.25 (.031)	1.750±.10 mm (.069±.004)	3.5±0.05 mm (.138±.002)	4.0±0.10 mm (.157±.004)	4.0±0.1 mm (.157±.004)	2.0±0.05 mm (.079±.002)	0.254±0.02 mm (.016)	8.0 mm + 0.3 mm - 0.1 mm (.312±.012)

Contact Information

Semtech Corporation
Protection Products Division
200 Flynn Rd., Camarillo, CA 93012
Phone: (805)498-2111 FAX (805)498-3804

Mouser Electronics

Authorized Distributor

Click to View Pricing, Inventory, Delivery & Lifecycle Information:

[Semtech:](#)

[UCLAMP0501T.TCT](#)