

tyco | *Electronics*

Product Catalogue

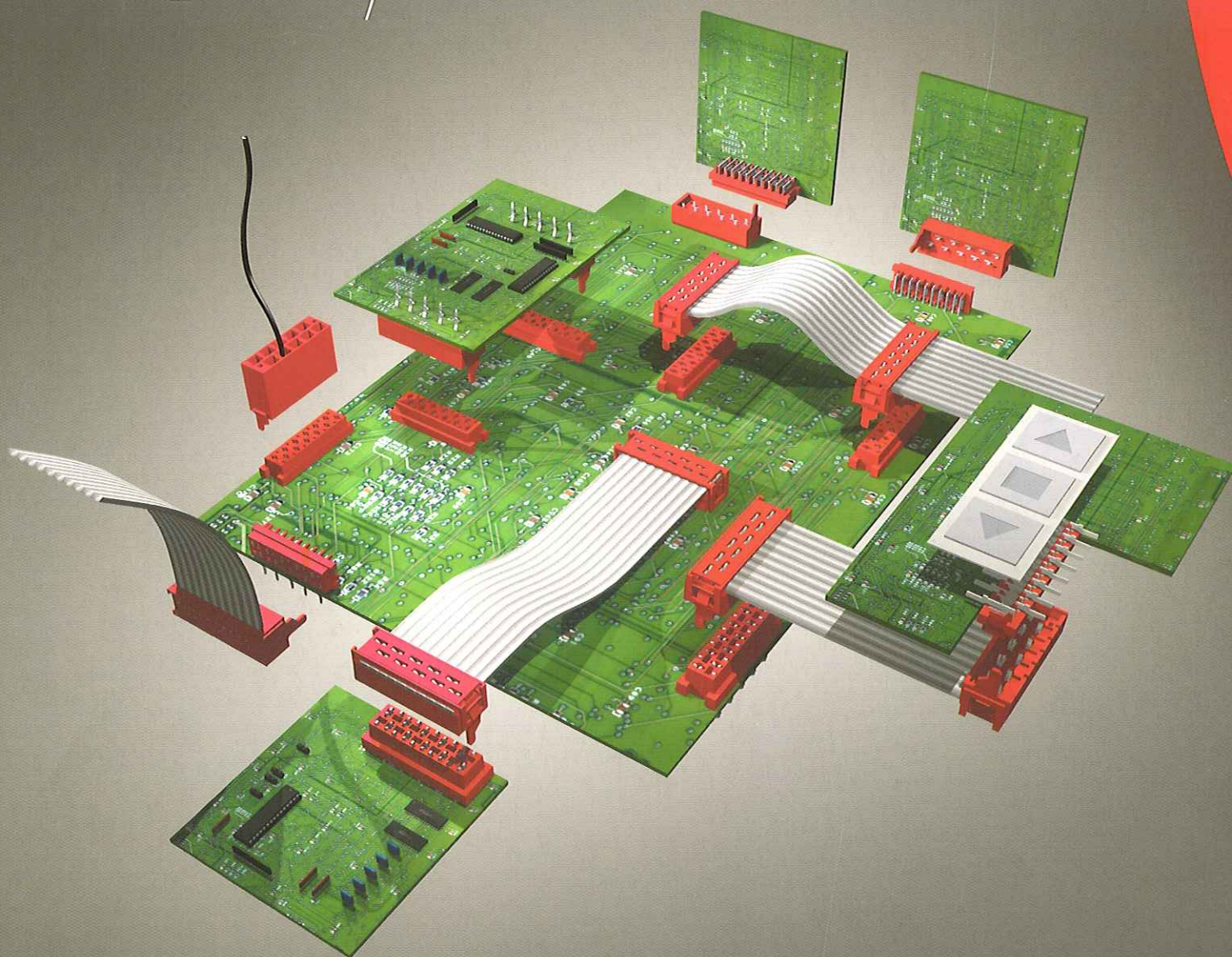

AMP *Micro-MaTch* Miniature Connector System

www.tycoelectronics.com

Table of Contents

Miniature Connector System	2
System Overview/Technical Data	3
Applications 3D	4
Applications 2D	5
Female-on-Board Connector Top Entry	6
Female-on-Board Connector Side Entry	7
Female-on-Board Connector Surface Mount Device (SMD)	8
Male-on-Board Connector	9
Male-on-Wire Connector	10
Paddle Board Connector	11
Crimp On Snap In (COSI) Connector	12
Specials	13
Application Tooling	14 & 15
Lead Assembly & Sample Box	16

AMP Micro-MaTch Miniature Connector System

Miniaturization and the trend towards higher density of electronic functions on a substrate led to the introduction of smaller interconnection systems. The AMP Micro-MaTch connector family, with its contact spacing of 1.27 mm, fully complies with the electronic packaging requirements of today and the future. The system offers a range of board and wire connectors, enabling a variety of wire-to-board and board-to-board interconnections. The AMP Micro-MaTch contact concept shown on this page is essentially different from other systems available.

By its design the traditional failure mode in tinplated connections, fretting corrosion, is prevented. Due to an additional positioning spring in the female part, relative movements caused by vibrations/thermal expansion between male and female contacts are absorbed. By preventing movements on the contact spot, a gas tight connection can be guaranteed under all circumstances.

The contact spring is located in the board connector and not in the cable connector, which is usually the case. The counter part, incorporated in the cable connector, is a simple pin, either with an insulation displacement section, suitable for the mass-termination of cable or with a kinked solder leg to be soldered onto a PC Board. The separation of these two basic functions of the contact system - contact force generation and wire termination -, enables the independent optimization of both functions and also leads to relatively simple contact shapes.

Because of their shapes contacts can be post-plated, leaving no bare edges in the contact and wire slot area. The contact spring system features an additional spring member - the positioning spring - which compensates positional tolerances. In this way the contact spring can be fully optimized for its basic function, so that the relatively high contact force, required for tin plated contact systems, can be guaranteed under all circumstances.

The Micro-MaTch contact spring system is absolutely fretting corrosion proof by its design.

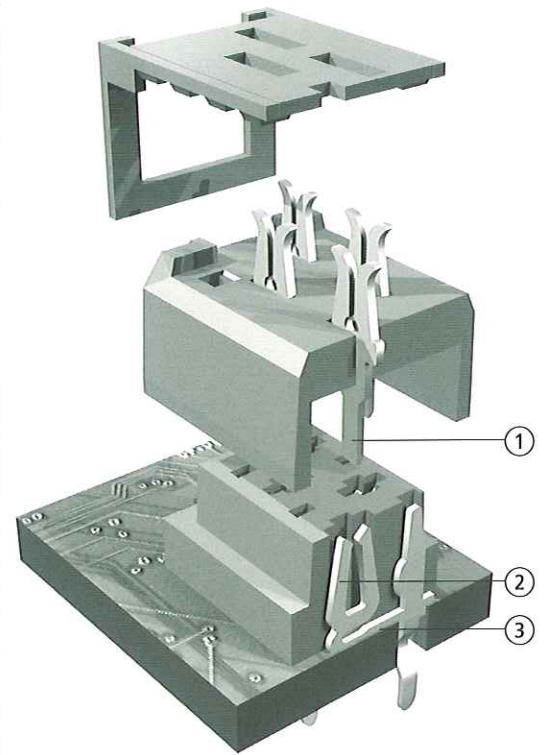

1. Contact Pin
2. Contact Spring
3. Positioning Spring

System Overview

Technical Data

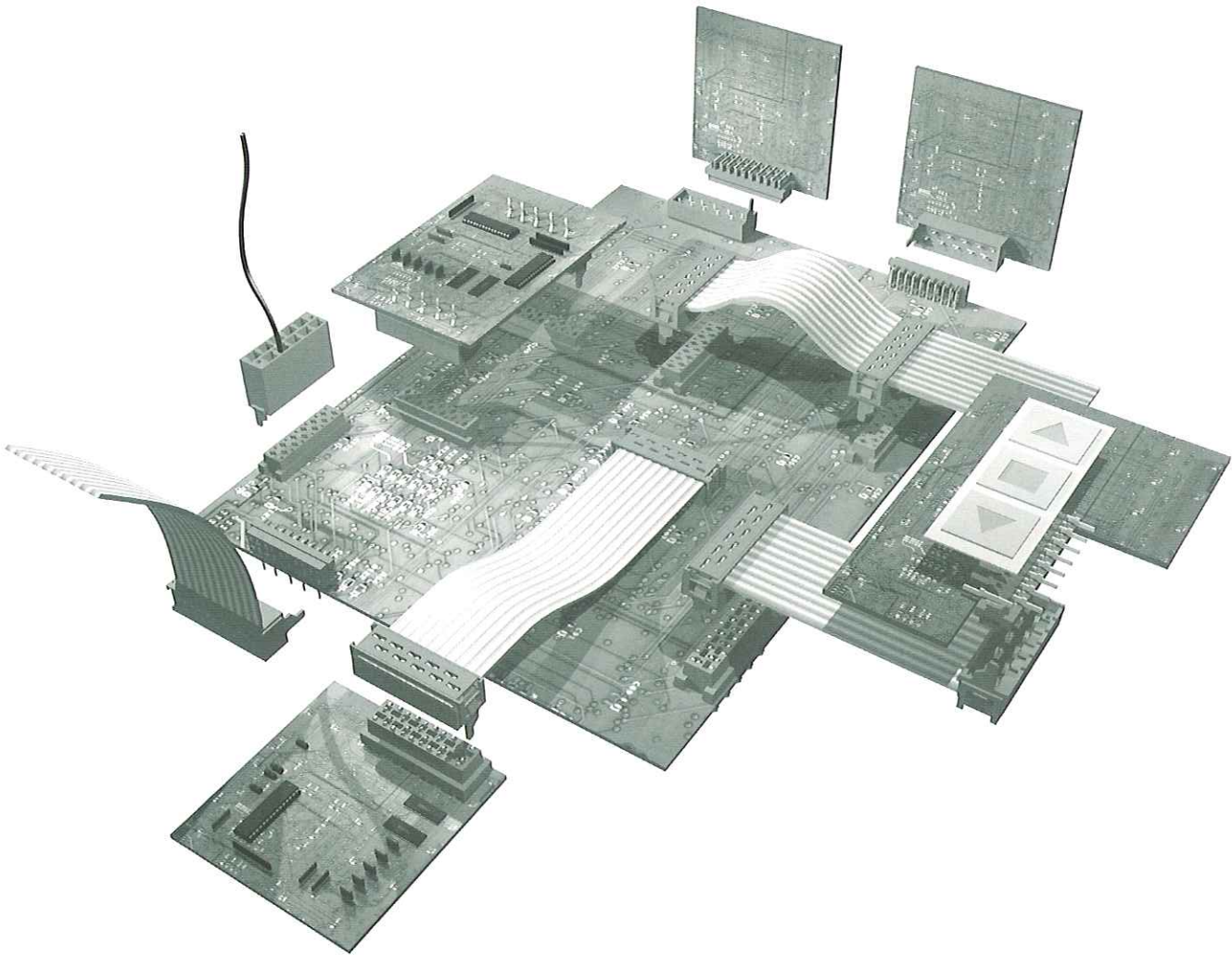

Technical Data

Centerline: 1.27 mm (staggered)
 Number of Positions: 4, 6, 8, 10, 12, 14, 16, 18, 20 and (some) 24 positions
 Contact Material: Phosphor bronze
 Contact Finish: Tin over Nickel
 Housing Material: Thermoplastic polyester, red, glass-filled
 For surface mount versions polyamide 4.6

Flammability rating: per UL 94 V-0
 UL-recognized: File E28476 Vol. 23 Section 4
 Contact Resistance: 10 MΩ max.
 Insulation Resistance: 1.000 MΩ min.
 Nominal Voltage: 230 V

Current Rating: 1.5 A max.
 Temperature Range: -40 °C to +105 °C (operating)
 Mating Force: 5N max. per contact
 Unmating Force: 1N min. per contact
 Minimum Contact Force: 2N min.

AMP Product Specification: 108-19052
 AMP Application Specification: 114-19016, 114-19051

RoHS Compliance Code:

Always RoHS compliant
 (directive 2002/95/EC) for all types
 Wave solder capable to 265 °C
 for through hole versions
 Reflow solder capable to 260 °C
 for SMD versions

Lead-free Process Capable:

PC Board Connectors

PC Board Thickness: 1.6 mm nominal
 PC Board Hole Diameter: 0.8 mm for solder connectors

Ribbon Connectors

Cable Type: Ribbon cable, UL Style 2651
 Conductor Spacing: 1.27 mm (.050")
 Conductor Diameter: Solid 0.30 mm diameter
 Stranded 0.08 mm²
 7 x 0.12 - 0.13 mm (other diameters and/
 or configurations on request)
 Insulation Type: semi-rigid PVC
 Insulation Diameter: 0.9 ± 0.1 mm

Discrete Wire (COSI) Connectors

Cable Type: AWG 28-24 and 24-20

Applications (3 dimensions)

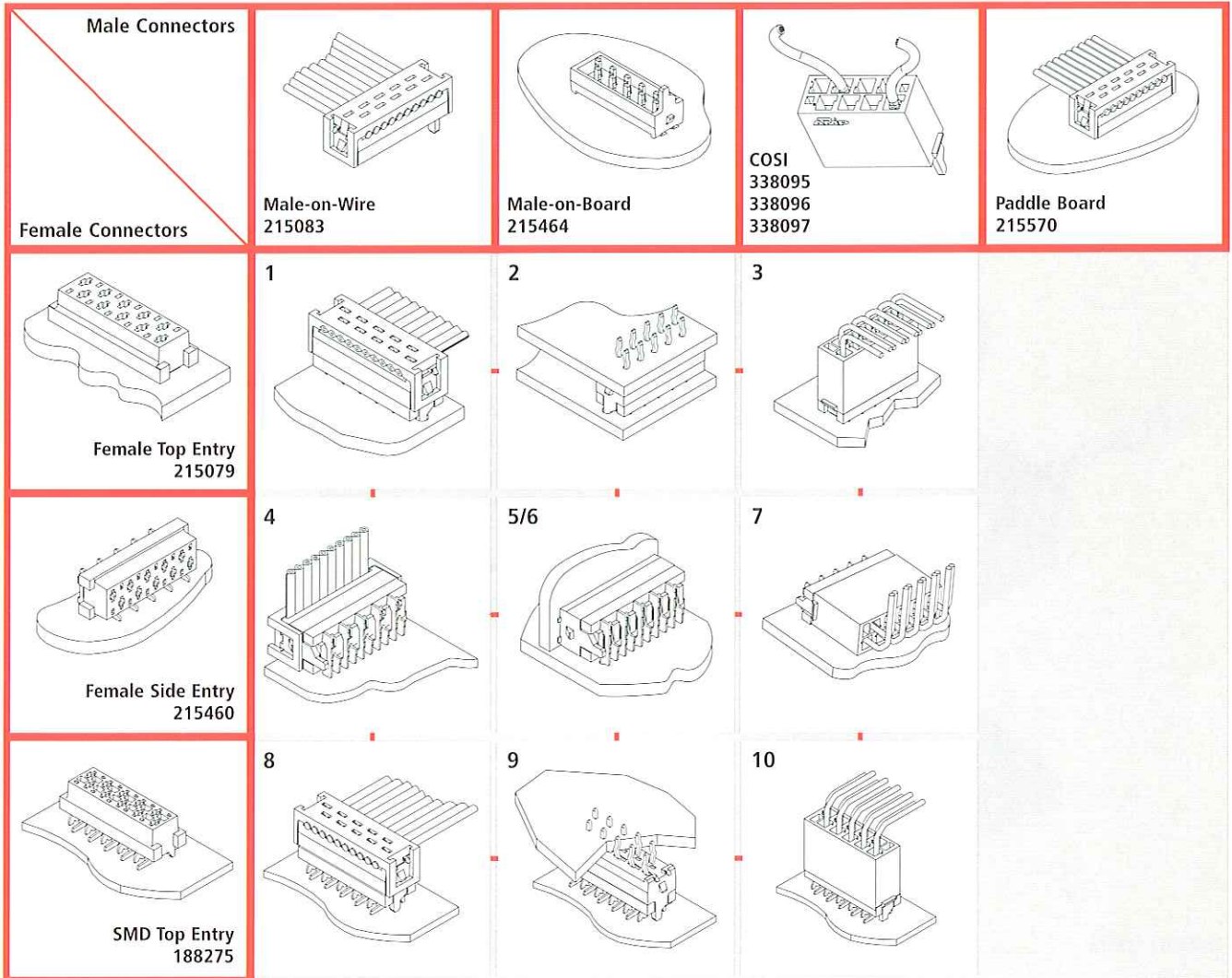

Image	Description (see also page 5)
1	Wire-to-Board through hole
2	Board-to-Board through hole
3	Wire-to-Board (discrete wire), through hole
4	Wire-to-Board right angle, through hole
5	Board-to-Board right angle, through hole
6	Board-to-Board right angle, through hole
7	Wire-to-Board right angle (discrete wire), through hole
8	Wire-to-Board surface mount
9	Board-to-Board surface mount, through hole
10	Wire-to-Board (discrete wire), surface mount

Applications (2 dimensions)

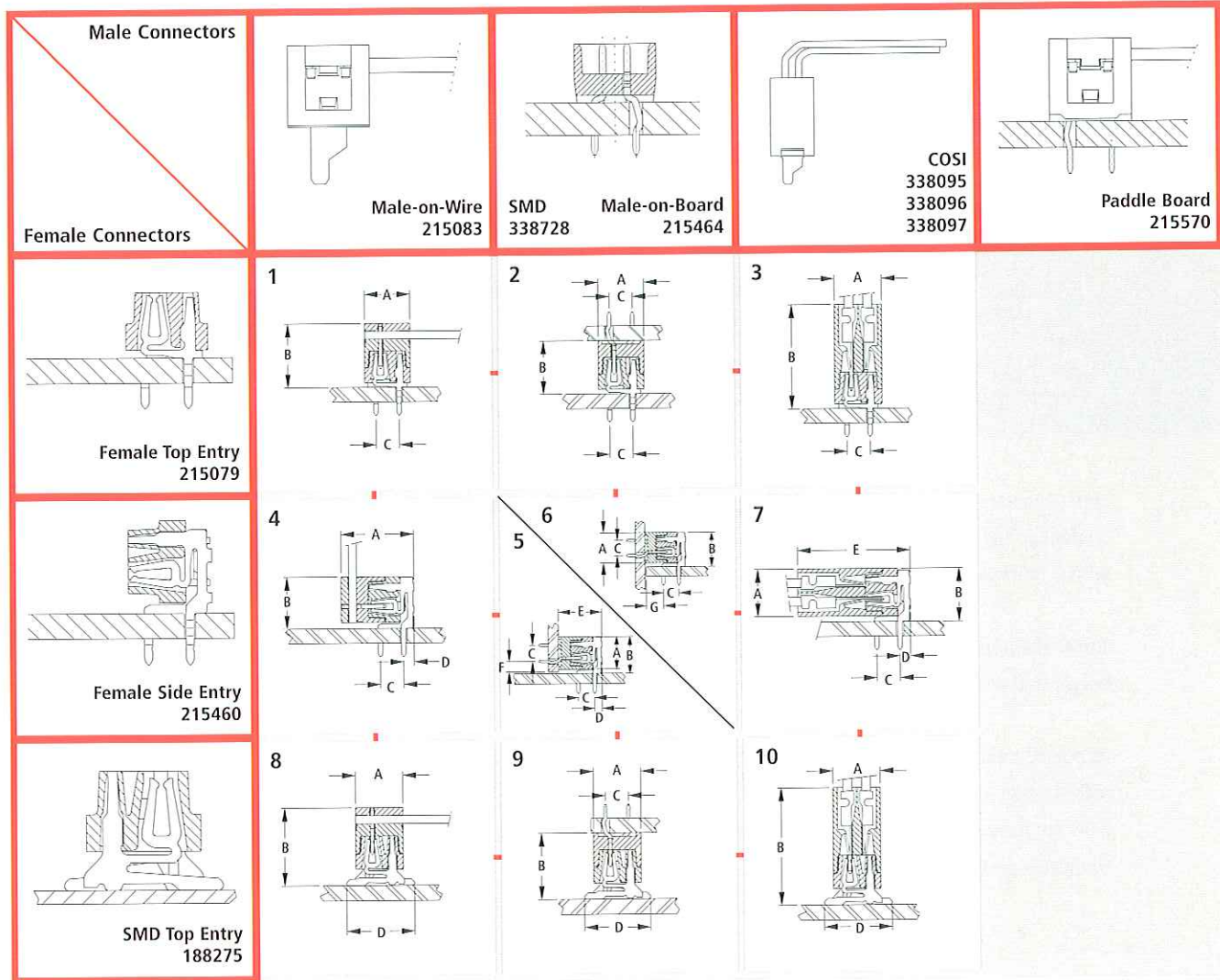
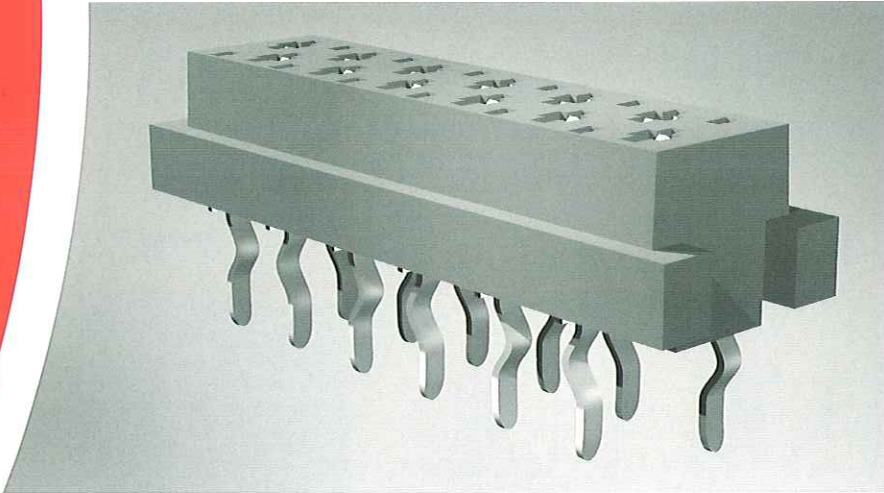

Image	A (max)	B (max)	C	D (max)	E (max)	F (max)	G (max)
1	5.2	7.5	2.54	-	-	-	-
2	5.2	6.2	2.54	-	-	-	-
3	5.2	9.7	2.54	-	-	-	-
4	8.4	5.9	2.54	1.5	-	-	-
5	5.2	5.9	2.54	1.5	7.0	1.6	-
6	5.2	5.9	2.54	1.5	-	-	2.8
7	5.2	5.9	2.54	1.5	10.6	-	-
8	5.2	8.5	-	7.1	-	-	-
9	5.2	7.1	2.54	7.1	-	-	-
10	5.2	10.7	-	7.1	-	-	-

Female-on-Board Connector

-Top Entry-



This connector version incorporates the patented AMP Micro-MaTch contact spring system and is designed to be soldered onto PC Boards with a nominal thickness of 1.6 mm.

The solder legs are indented, providing firm retention of the connector before and during the soldering operations.

As polarization is accomplished directly between the AMP Micro-MaTch male connectors and the PC Board, this top entry female connector does not have any polarizing features. Therefore, the orientation of the connector on the PC Board is irrelevant.

Notes:

1. Connectors are always sideways mounted onto an adhesive tape.
2. Standard packaging quantity is 2500 connectors on a reel with a diameter of 600 mm.
3. At additional charge a special packaging option is available: 250 connectors on a reel with a diameter of 250 mm, packed in a dedicated dispenser box.

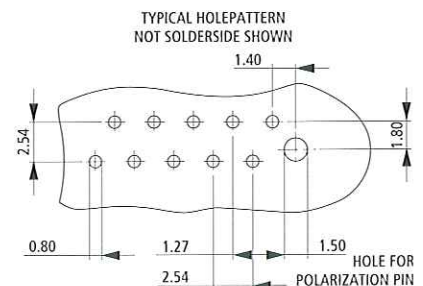
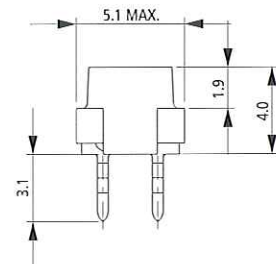
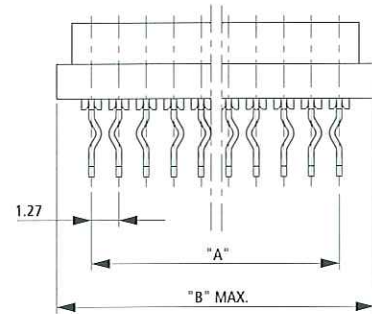
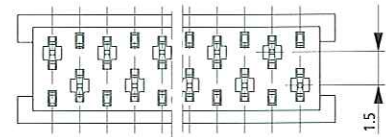

No. of Positions	Dimensions mm		Part Numbers	
	A	B	2500 Connectors/Reel	250 Connectors/Box
4	3.81	7.1	215079-4	7-215079-4
6	6.35	9.7	215079-6	7-215079-6
8	8.89	12.2	215079-8	7-215079-8
10	11.43	14.7	1-215079-0	8-215079-0
12	13.97	17.3	1-215079-2	8-215079-2
14	16.51	19.8	1-215079-4	8-215079-4
16	19.05	22.4	1-215079-6	8-215079-6
18	21.59	24.9	1-215079-8	8-215079-8
20	24.13	27.4	2-215079-0	9-215079-0

Female-on-Board Connector -Side Entry-

Basic Part No. 215460

Notes:

1. Connectors are always sideways mounted onto an adhesive tape.
2. Standard packaging quantity is 2500 connectors on a reel with a diameter of 600 mm.
3. At additional charge a special packaging option is available: 250 connectors on a reel with a diameter of 250 mm, packed in a dedicated dispenser box.

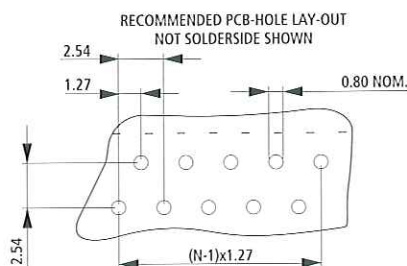
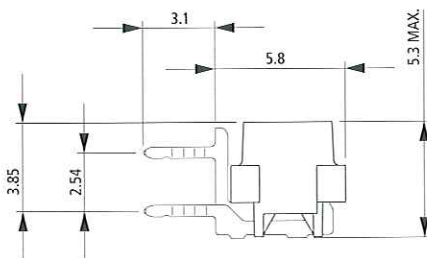
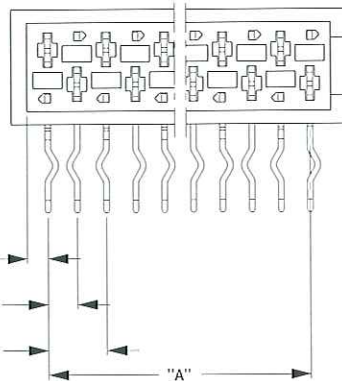
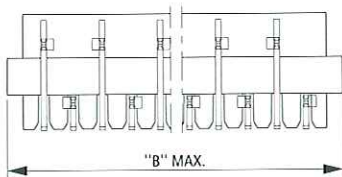
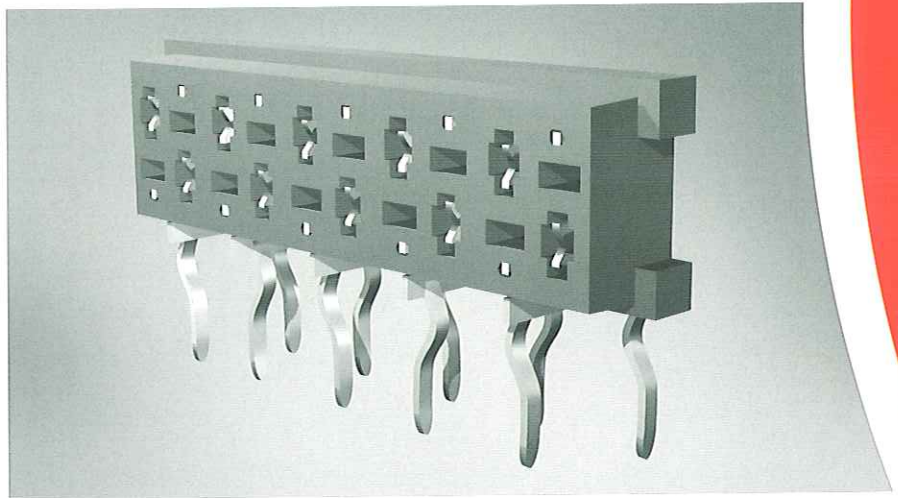

This connector version is identical to the top entry version with two exceptions:

- The solder legs are parallel to the mating face of the connector instead of perpendicular.
- It's housing is polarized, so that polarization is accomplished directly between the two mating connectors. Proper orientation of the connectors on the PC Board is relevant here.

No. of Positions	Dimensions mm		Part Numbers	
	A	B	2500 Connectors/Reel	250 Connectors/Box
4	3.81	7.1	(1500) 215460-4	7-215460-4
6	6.35	9.7	215460-6	7-215460-6
8	8.89	12.2	215460-8	7-215460-8
10	11.43	14.7	1-215460-0	8-215460-0
12	13.97	17.3	1-215460-2	8-215460-2
14	16.51	19.8	1-215460-4	8-215460-4
16	19.05	22.4	1-215460-6	8-215460-6
18	21.59	24.9	1-215460-8	8-215460-8
20	24.13	27.4	2-215460-0	9-215460-0

Female-on-Board Connector

Surface Mount Device (SMD)

Basic Part No. 188275

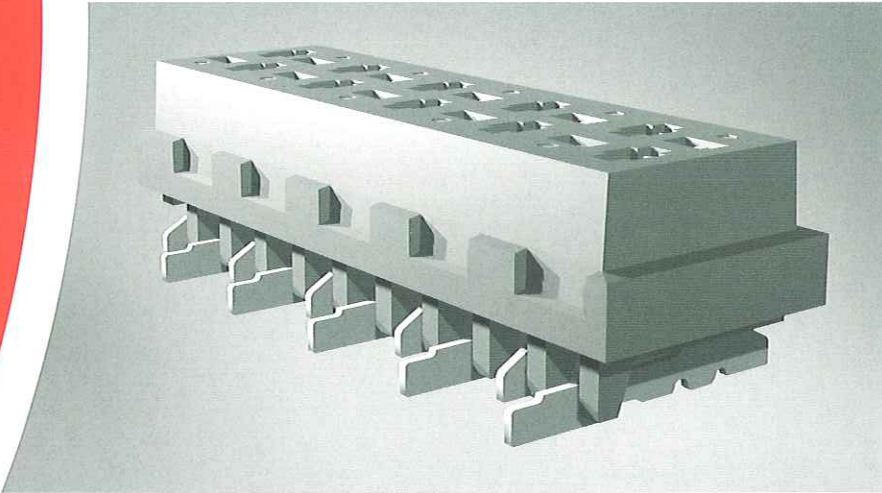

This SMD connector version is designed for standard reflow and infrared solder processes ("FULL SMD"). Polarization is accomplished by the housing, therefore no polarization holes in the PC Board are required.

The contact is designed with an additional spring to compensate for differences in thermal expansion between housing and PCB. Due to this feature, tension on solder joints is prevented.

Notes:

1. To enable automatic Pick & Placement, connectors are always packed in embossed tape according EIA481 specification.
2. Standard packaging quantity is 900 pcs on a reel with a diameter of 330 mm.
3. Connectors are supplied with or without a feature for vacuum Pick & Placement.
4. For this connector no additional solder hold down is required.

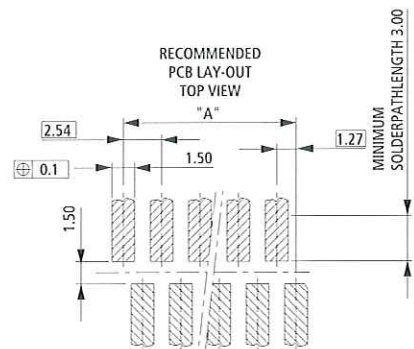
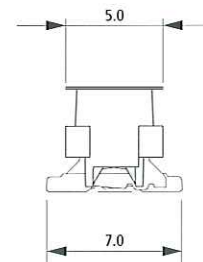
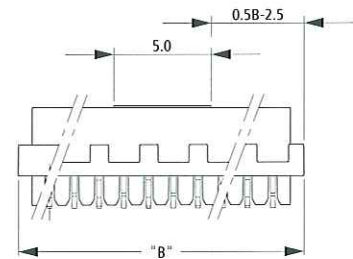
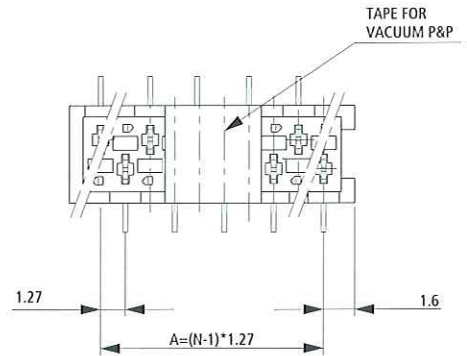

No. of Positions	Dimensions mm		Part Numbers	
	A	B	Without vacuum tape	With vacuum tape
4	3.81	7.1	188275-4	7-188275-4
6	6.35	9.7	188275-6	7-188275-6
8	8.89	12.2	188275-8	7-188275-8
10	11.43	14.7	1-188275-0	8-188275-0
12	13.97	17.3	1-188275-2	8-188275-2
14	16.51	19.8	1-188275-4	8-188275-4
16	19.05	22.4	1-188275-6	8-188275-6
18	21.59	24.9	1-188275-8	8-188275-8
20	24.13	27.4	2-188275-0	9-188275-0

Male-on-Board Connector

Basic Part No. 215464

Notes:

1. Connectors are always sideways mounted onto an adhesive tape.
2. Standard packaging quantity is 2500 connectors on a reel with a diameter of 600 mm.
3. At additional charge a special packaging option is available: 250 connectors on a reel with a diameter of 250 mm, packed in a dedicated dispenser box.

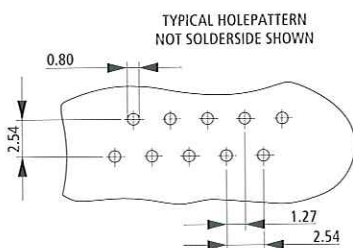
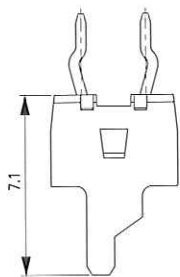
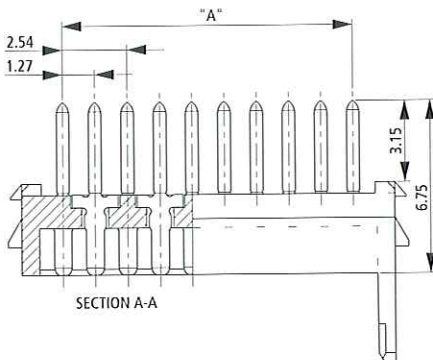
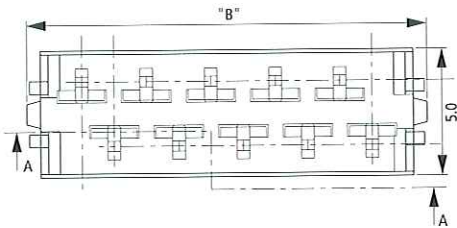
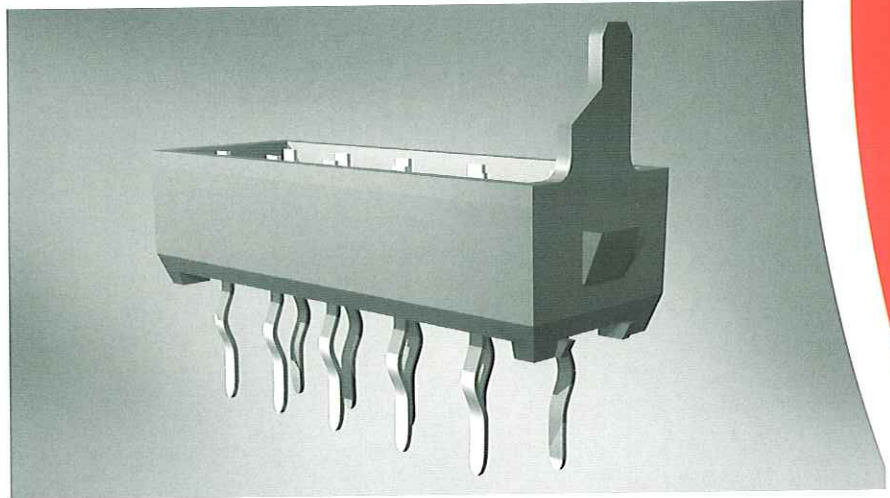

This male connector version is designed to be soldered onto PC Boards with a nominal thickness of 1.6 mm.

The solder legs are indented for firm retention of the connector in the PC Board.

The connector housing features a polarizing pin on one end for proper orientation of this connector version.

No. of Positions	Dimensions mm		Part Numbers	
	A	B	2500 Connectors/Reel	250 Connectors/Box
4	3.81	8.2	215464-4	7-215464-4
6	6.35	10.7	215464-6	7-215464-6
8	8.89	13.3	215464-8	7-215464-8
10	11.43	15.8	1-215464-0	8-215464-0
12	13.97	18.3	1-215464-2	8-215464-2
14	16.51	20.8	1-215464-4	8-215464-4
16	19.05	23.4	1-215464-6	8-215464-6
18	21.59	25.9	1-215464-8	8-215464-8
20	24.13	28.4	2-215464-0	9-215464-0

Male-on-Wire Connector

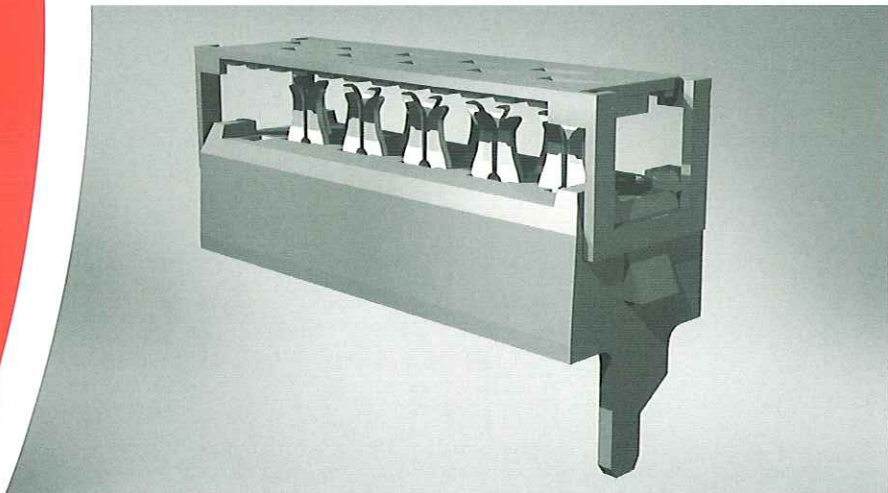

For the wire connection, a well-known AMP-LATCH type blade with a single slot is used. The insides of the slots are tin plated for stable and reliable connections.

The connector is supplied with a pre-assembled cover, providing excellent positioning of the ribbon cable before and during the insulation displacement process.

After termination the cover is held in place by each individual contact in addition to two plastic latches at both ends of the connector.

Remark:

The AMP Micro-MaTch Male-on-Wire connector is specifically designed to be disengaged from its counterpart by pulling the cable in the appropriate direction.

Notes:

1. Connectors are always sideways mounted onto an adhesive tape.
2. Standard packaging quantity is 2500 connectors on a reel with a diameter of 600 mm.
3. At additional charge a special packaging option is available: 250 diameter of 250 mm, packed in a dedicated dispenser box.

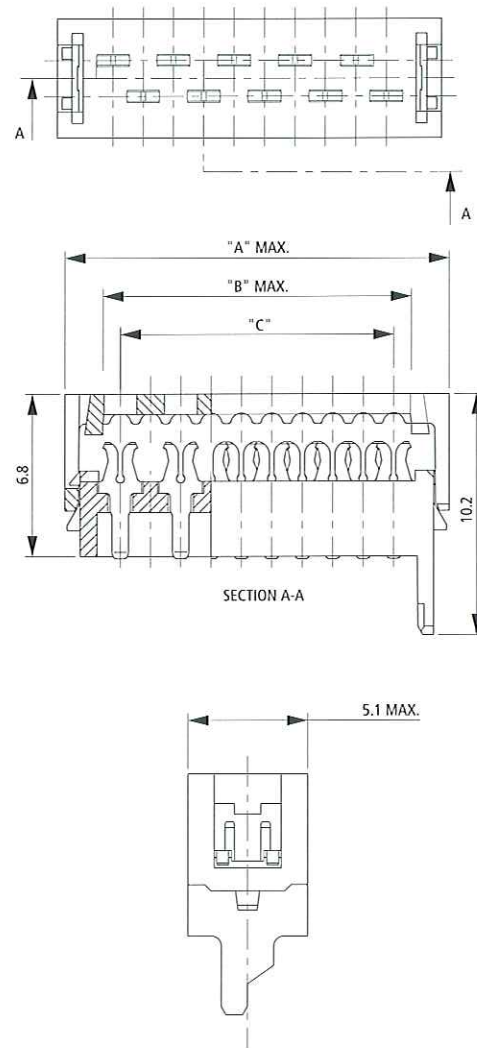

No. of Positions	Dimensions mm			Part Numbers	
	A	B	C	2500 Connectors/Reel	250 Connectors/Box
4	8.6	5.4	3.81	215083-4	7-215083-4
6	11.1	8.0	6.35	215083-6	7-215083-6
8	3.6	10.5	8.89	215083-8	7-215083-8
10	16.2	13.0	11.43	1-215083-0	8-215083-0
12	18.7	15.6	13.97	1-215083-2	8-215083-2
14	21.3	18.1	16.51	1-215083-4	8-215083-4
16	23.8	20.7	19.05	1-215083-6	8-215083-6
18	26.3	23.2	21.59	1-215083-8	8-215083-8
20	28.9	25.7	24.13	2-215083-0	9-215083-0
24	34.0	30.8	29.21	2-215083-4	9-215083-4

Paddle Board Connector

Basic Part No. 215570

Notes:

1. Connectors are always sideways mounted onto an adhesive tape.
2. Standard packaging quantity is 2500 connectors on a reel with a diameter of 600 mm.
3. At additional charge a special packaging option is available: 250 connectors on a reel with a diameter of 250 mm packed in a dedicated dispenser box.

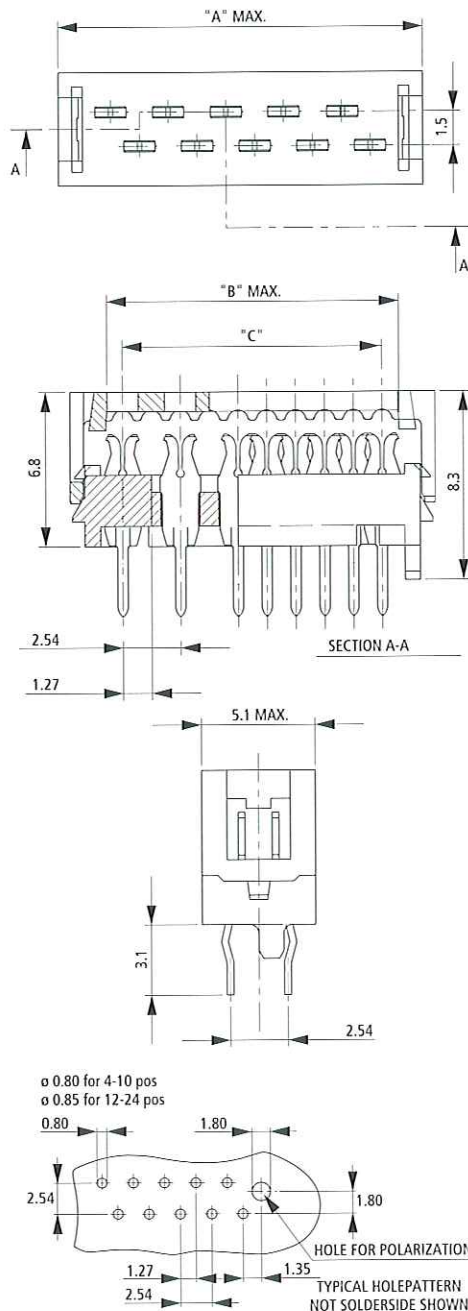
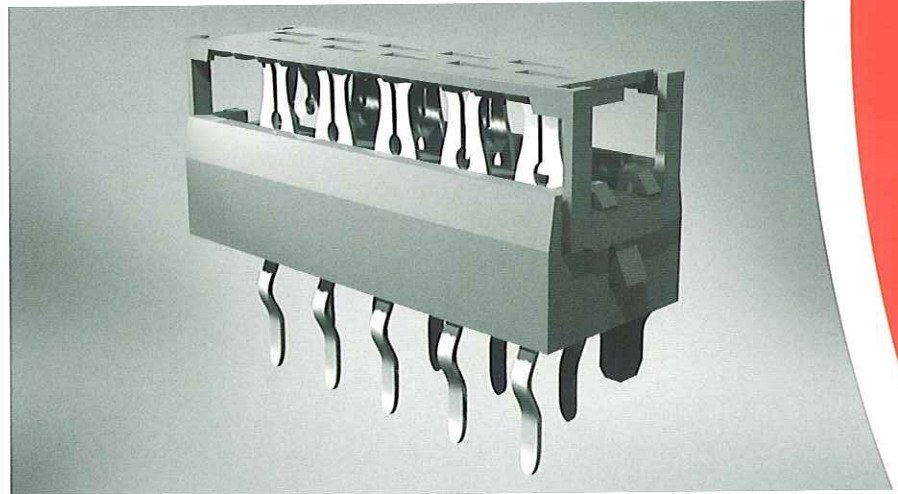

Direct soldering of a ribbon cable onto a PC Board is a very difficult job with the smaller sizes of ribbon cable. If such a permanent cable connection is required, the application can be facilitated by using this connector type.

The Paddle Board connector is applied to the ribbon cable with the same application tooling, available for the termination of the Male-on-Wire connector.

The solder legs are indented and provide mechanical retention of the connector/cable assembly in the PC Board before and during soldering.

This Paddle Board connector version is designed to be soldered onto PC Boards with a nominal thickness of 1.6 mm.

No. of Positions	Dimensions mm			Part Numbers	
	A	B	C	2500 Connectors/Reel	250 Connectors/Box
4	8.6	5.4	3.81	215570-4	7-215570-4
6	11.1	8.0	6.35	215570-6	7-215570-6
8	3.6	10.5	8.89	215570-8	7-215570-8
10	16.2	13.0	11.43	1-215570-0	8-215570-0
12	18.7	15.6	13.97	1-215570-2	8-215570-2
14	21.3	18.1	16.51	1-215570-4	8-215570-4
16	23.8	20.7	19.05	1-215570-6	8-215570-6
18	26.3	23.2	21.59	1-215570-8	8-215570-8
20	28.9	25.7	24.13	2-215570-0	9-215570-0
24	34.0	30.8	29.21	2-215570-4	-

Crimp On Snap In (COSI) Connector

Basic Part No. 338095 + Contacts 338096, 338097

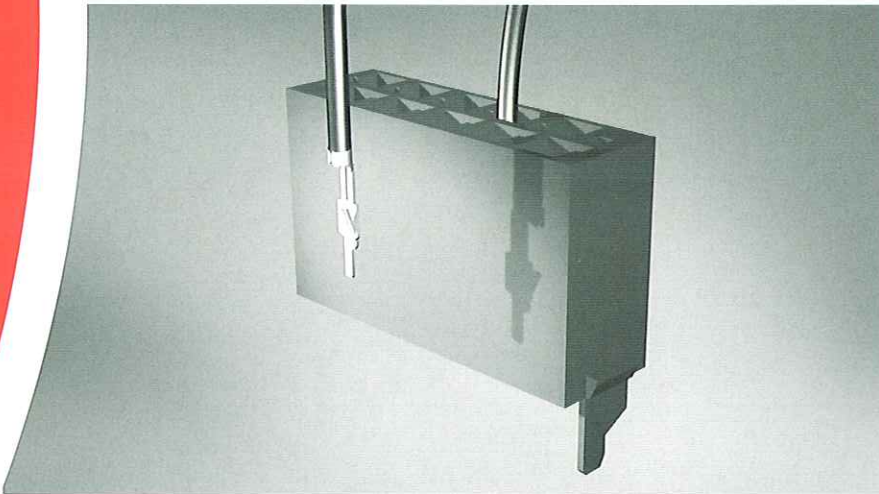

This crimp version for discrete Wire-to-Board applications is fully compatible with all female connectors of the Micro-MaTch family.

Insulation and wire crimp barrel are copies of the well proven AMPLIMITE contacts. After mating with a Micro-MaTch female connector the contacts are fully protected by isolating plastics. Contacts are made of a pretinned Phosphorbronze.

Contacts are supplied in a range for 24-20 AWG and 28-24 AWG. For repair operations an extraction tool is available; PN 734873-1.

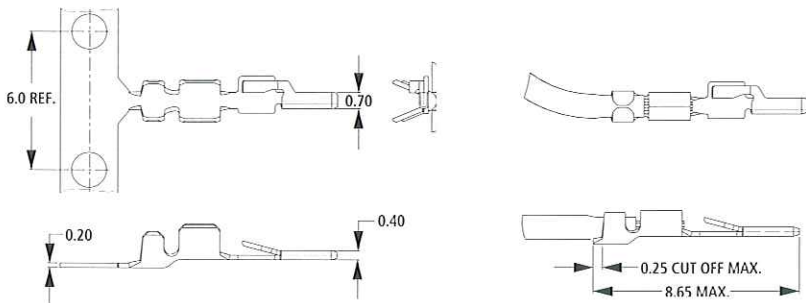

Wire Size Range		Insulation diameter	Partnumber	Partnumber
(mm ²)	(AWG)	(mm)	Large reel, 15,000	Small reel, 750
0.08-0.20	28-24	0.76-1.00	338096-1	1-338096-1
0.20-0.50	24-20	1.27-1.52	338097-1	1-338097-1

No. of Positions	Dimensions mm			Part Numbers	Number of pcs/box
	A	B	C		
4	7.2	8.4	3.81	338095-4	900
6	9.8	10.9	6.35	338095-6	700
8	12.3	13.5	8.89	338095-8	500
10	14.9	16.0	11.43	1-338095-0	450
12	17.4	18.5	13.97	1-338095-2	400
14	19.9	21.1	16.51	1-338095-4	350
16	22.5	23.6	19.05	1-338095-6	300
18	25.0	26.2	21.59	1-338095-8	250
20	27.6	28.7	24.13	2-338095-0	200

Notes:

1. Contacts can be crimped using a G-terminator or mini stripper crimper based applicator.
2. For the contacts on strip the standard packaging quantity is 15,000 pcs on a reel with a diameter of 600 mm.
3. For repair/service contacts are packaged 750 pcs. Per reel, to be used with handtools.
4. The housings are bulk packed in a box with a packaging quantity varying from 200 to 900 pcs per box.

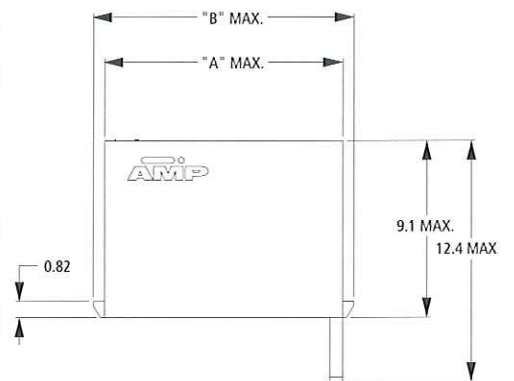
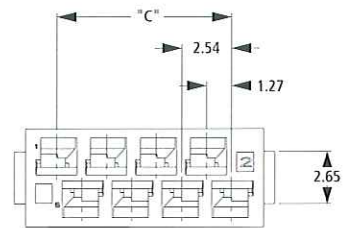

- SMC connector - Locking Latch - In-board SMD - Male SMD -

SMC connector: 100411

This connector type enables a solderless application to the printed circuit board. Contact is made on the surface of the PCB, enabling the use of paperphenol and epoxy boards with both drilled and punched holes. This connector is suitable for both Wire-to-Board as Board-to-Board connections. Because this connector is mounted on the solderside, the components of both PCB's in a parallel Board-to-Board application, will be in the same direction. By this, the stacking of two or more PCB's is possible. Application tooling available on request.

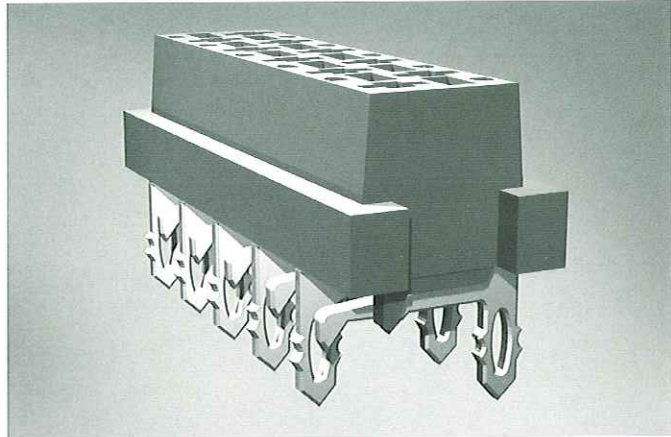

Locking Latch: 338068/338069/338070

For Wire-to-Board applications this feature provides an audible click during mating. This feature is available for the standard Micro-MaTch female connectors. Cross reference is made by base partnumber: x-338068-x instead of x-215079-x, x-338069-x instead of x-188275-x and x-338070-x instead of x-215460-x (standard large reel packaging only). Partnumber 338069 is also available for 24 positions.

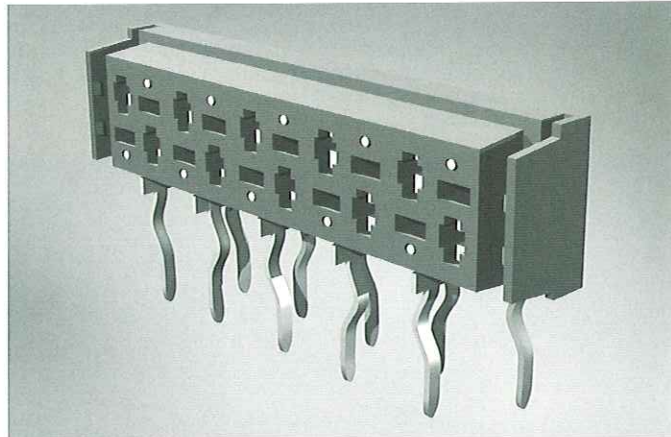

In-board SMD: 188431

This connector is only tooled in 20 position (9-188431-0) and packaged in embossed tape according to EIA481 standards. The connectors are equipped with a feature for vacuum Pick & Placement. It enables the mounting of a PCB with the solderside direct behind e.g. a display. It is also possible to obtain a parallel BTB application with an extreme low PCB distance of 4.2 mm.

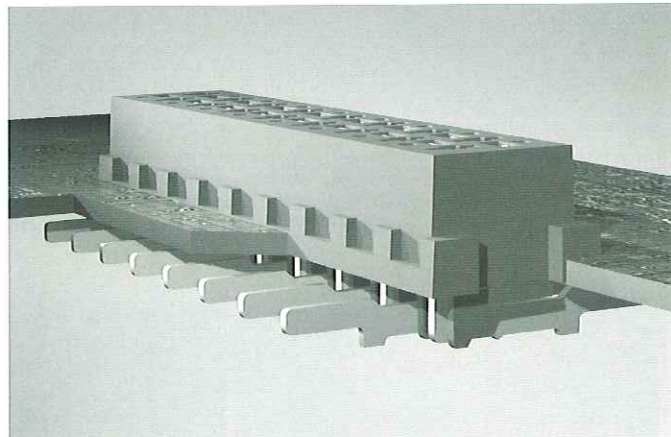

Male SMD: 338728

This connector enables the possibility to have a full SMD to SMD Board-to-Board application. It mates with all Micro-MaTch female connectors, and will be packaged according EIA 481 standard. Consult Tyco Electronics-AMP for more information.

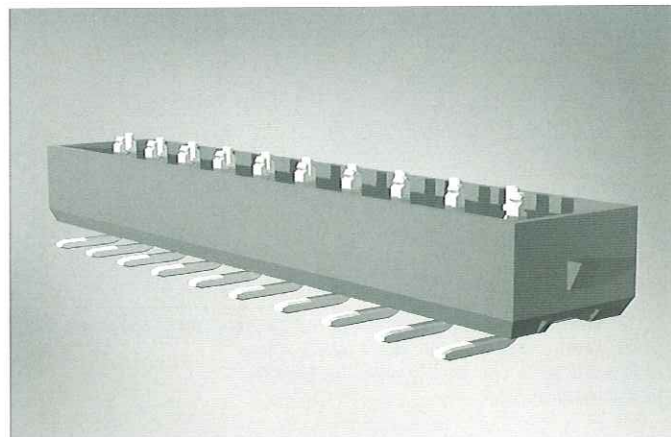

Application Tooling

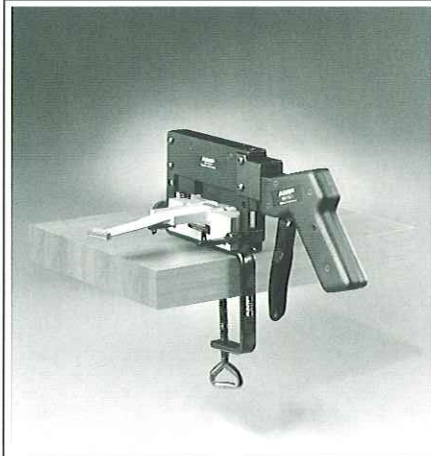

Pistol handgrip tooling. This is a handtool for terminating Micro-MaTch Male-on-Wire and Paddle Board connectors. Meant for small quantities or repair services. Pistol handgrip and adaptor must be ordered separately.

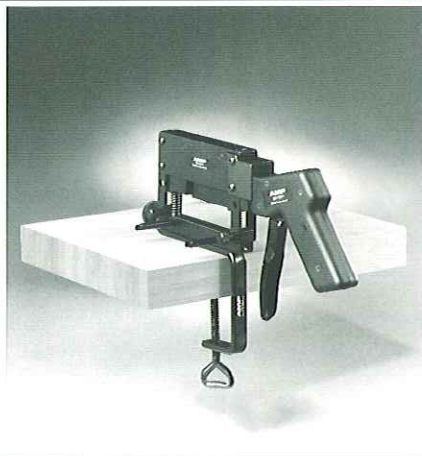

Standard pistol handgrip PN = 734155-1. This basic tool can be used for both Micro-MaTch and AMP-LATCH applications.

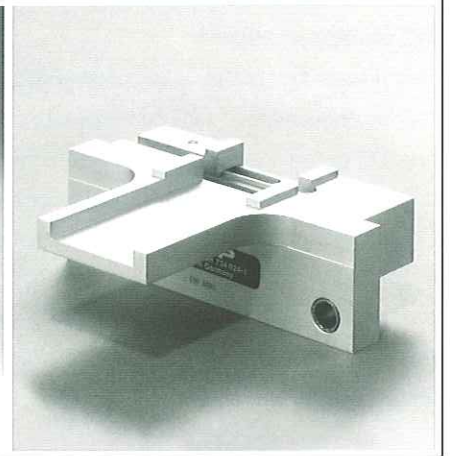

Pistol handgrip adapter set PN = 734024-1. This adapter can be used for Micro-MaTch terminations, together with the pistol handgrip.

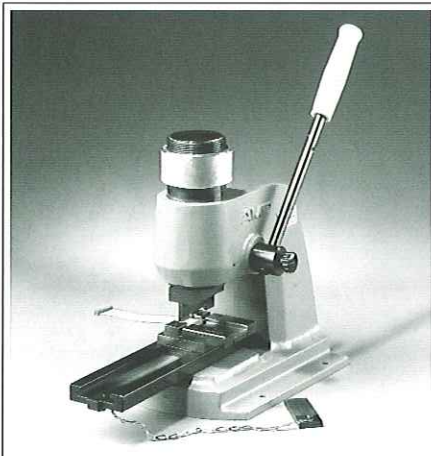

Bench press tooling PN 733280-3. This complete tool includes a Micro-MaTch dedicated tool set mounted on the bench press 654173-2.



Bench press PN 91085-2. This basic press is a hand operated version. This press can also be obtained in a pneumatically operated version; PN = 91112-3.

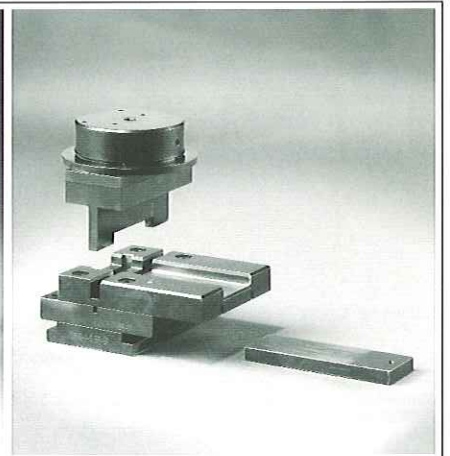

Bench press tool set PN 733278-2. This tool set is designed especially for Micro-MaTch. It fits both pneumatically and hand operated press.

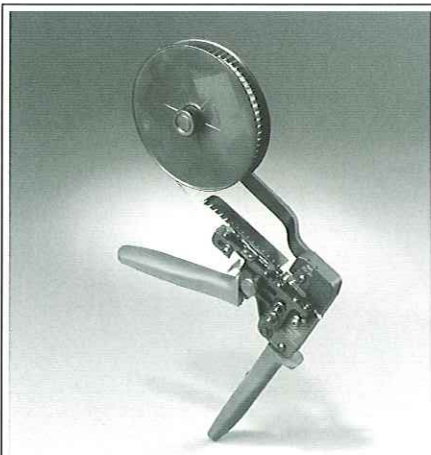

COSI Handtooling PN 734870-1. For 24-20 AWG, PN 734870-2 for 28-24 AWG. These dedicated tools can be obtained for services/repair applications.

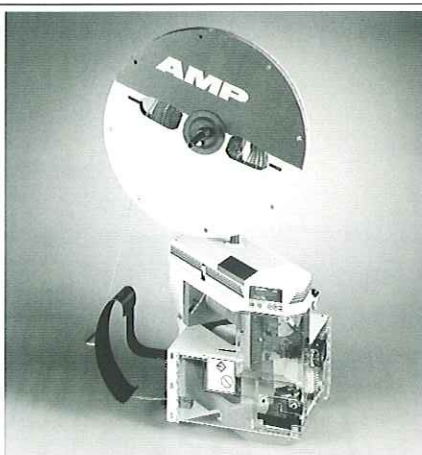

G-terminator PN 677-499-1.

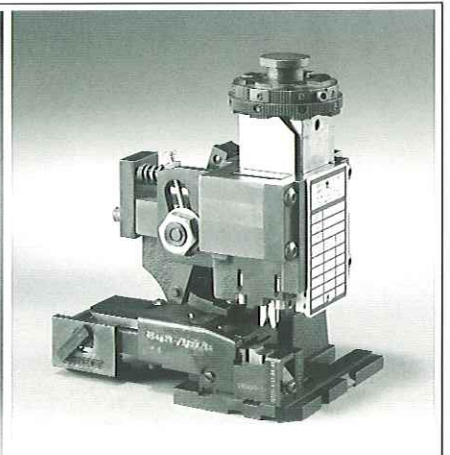

Applicators for G-terminator. PN 677894-1 for AWG 28-24 (PN 338096-1). PN 677895-1 for AWG 24-20 (PN 338097-1).

Application Tooling

Semi automatic tooling PN 677410-1. This tool can be used for Micro-MaTch lead end and for daisy chain assembly applications.

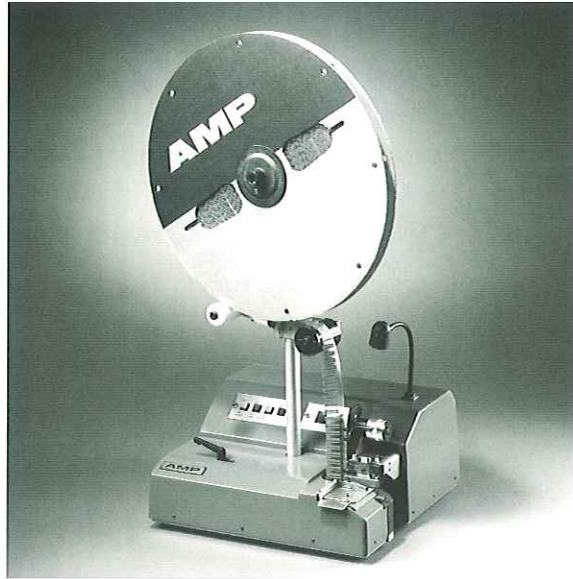

Semi automatic tooling PN 677412-5. For Micro-MaTch only and 1-677412-0 for both Micro-MaTch and AMP-LATCH. This machine can be used for lead end assemblies.

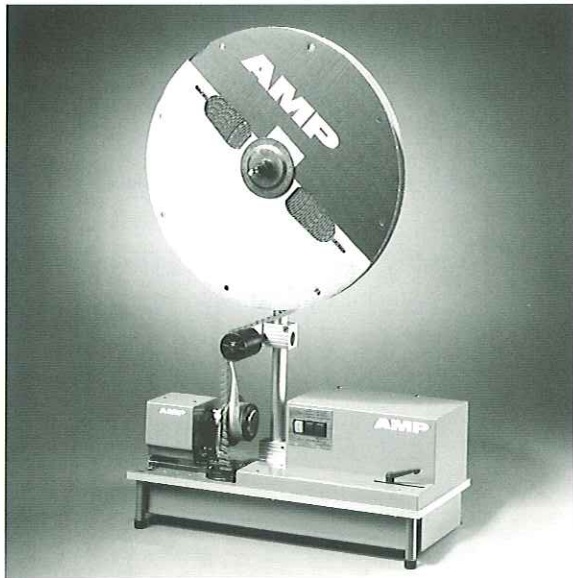

Connector dispenser PN 677463-1. The dispenser accepts the Micro-MaTch standard reels (2500 pcs/reel). It automatically removes the pre-set connector quantity from the reel and drops it in a separate box. Quantity can easily be programmed by the user.

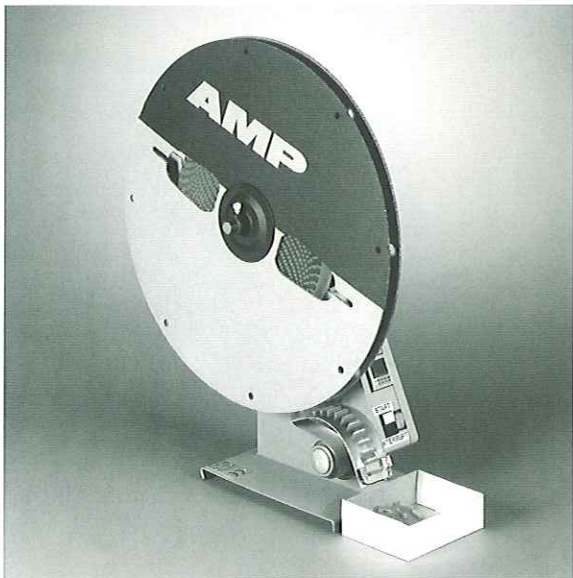

Lead Assembly

It is possible to deliver custom made Micro-MaTch lead assemblies, both cable end assemblies and daisy-chain assemblies, in all positions between 4 and 20 in all required cable lengths. All leads are 100% electrically tested on shortcut and connection before shipment. A flexible 7 stranded cable is used for easy assembly. Special cable on request. For order information contact Tyco Electronics-AMP.



Sample Box

Partnumber: 1377074-1

This box includes samples of all connector types within the Micro-MaTch family, examples of leads, printed circuit boards and a CD-ROM. The CD-ROM includes an electronic version of this catalogue, an animation of the contact principle and CAD files of all connector types.

This sample box is an aid in visualizing the variety of applications where Micro-MaTch can be implemented.



Tyco Electronics-AMP Worldwide

Americas

Argentina – Buenos Aires
Phone: +54-1-733-2000
Fax: +54-1-717-0988

Brazil – Sao Paulo
Phone: +55-11-861-1311
Fax: +55-11-861-0397

Canada – Toronto
Phone: +1-905-475-6222
Fax: +1-905-474-5520

Chile – Santiago
Phone: +56-2-739-1230
Fax: +56-2-739-1227

Colombia – Bogota
Phone: +57-1-231-9398
Fax: +57-1-240-3769

Mexico – Mexico City
Phone: +52-5-729-0400
Fax: +52-5-361-8545

United States – Harrisburg, PA
Phone: +1-717-564-0100
Fax: +1-717-986-7575

Venezuela – Caracas
Phone: +58-2-986-7774
Fax: +58-2-986-9739

For Latin/South American
Countries not shown
Phone: +54-11-4733-2015
Fax: +54-11-4733-2083

Asia/Pacific

Australia – Sydney
Phone: +61-2-9840-8200
Fax: +61-2-9899-5649

India – Bangalore
Phone: +91-80-841-0200
Fax: +91-80-841-0210

Indonesia – Jakarta
Phone: +6221-526-7852
Fax: +6221-526-7856

Japan – Tokyo
Phone: +81-44-844-8111
Fax: +81-44-812-3207

Korea – Seoul
Phone: +82-2-3274-0535
Fax: +82-2-3274-0524/0531

Malaysia – Selangor
Phone: +60-3-7053055
Fax: +60-3-7053066

New Zealand – Auckland
Phone: +64-9-634-4580
Fax: +64-9-634-4586

Philippines – Makati City
Phone: +632-867-8641
Fax: +632-867-8661

People's Republic of China
Hong Kong
Phone: +852-2735-1628
Fax: +852-2735-0243

Shanghai
Phone: +86-21-6485-0602
Fax: +86-21-6485-0728

Shunde
Phone: +86-765-775-1368
Fax: +86-765-775-2823

Singapore – Singapore
Phone: +65-482-0311
Fax: +65-482-1012

Taiwan – Taipei
Phone: +886-2-2325-0391
Fax: +886-2-2325-0398

Thailand – Bangkok
Phone: +66-2-955-0500
Fax: +66-2-955-0505

Vietnam – Ho Chi Minh City
Phone: +84-8-8232-546/7
Fax: +84-8-8221-443

Europe/Middle East/Africa

Austria – Vienna
Inside:
Phone: +(0222) 277-97-0
Fax: +(0222) 277-97-333
Outside:
Phone: +43-1-277-97-0
Fax: +43-1-277-97-333

Belgium – Kessel-Lo
Phone: +32-16-352-300
Fax: +32-16-352-352

Bulgaria – Sofia
Phone: +359-2-971-2152
Fax: +359-2-971-2153

Croatia – Zagreb
Phone: +385-1-67-04-46
Fax: +385-1-69-16-04

Czech Republic – Kurim
Phone: +420-5-41-162-111
Fax: +420-5-41-162-223

Denmark – Viby
Phone: +45-86-295-055
Fax: +45-86-295-133

Egypt – Cairo
Phone: +20-2-417-76-47
Fax: +20-2-419-23-34

Estonia – Haabneeme
Phone: +372-6205-900
Fax: +372-6205-980

Finland – Helsinki
Phone: +358-9-512-3420
Fax: +358-9-512-34250

France – Pontoise
Phone: +33-1-3420-8888
Fax: +33-1-3420-8600

France
AMP Export – Pontoise
Phone: +33-1-3420-8383
Fax: +33-1-3420-8609 or
+33-1-3420-8662

France
SIMEL – Gevrey-Chambertin
Phone: +33-3-8058-3200
Fax: +33-3-8034-1015

Germany – Bensheim
Phone: +49-6251-133-0
Fax: +49-6251-133-600

Germany
HTS – Neunkirchen
Phone: +49-2247-305-0
Fax: +49-2247-305-122

Great Britain – London
Phone: +44-181-954-2356
Fax: +44-181-954-6234

Greece – Athens
Phone: +30-1-9370-396/397
Fax: +30-1-9370-655

Hungary – Budapest
Phone: +36-1-350-8633
Fax: +36-1-350-8634

Ireland – Dublin
Phone: +353-1-820-3000
Fax: +353-1-820-9790

Israel – Tel Aviv
Phone: +972-3-649-1482
Fax: +972-3-648-4041

Italy – Torino
Phone: +39-011-401-2111
Fax: +39-011-403-1116

Lithuania – Vilnius
Phone: +370-2-231-402
Fax: +370-2-231-403

Netherlands – 's-Hertogenbosch
Phone: +31-73-6246-246
Fax: +31-73-6212-365

Norway – Nesbru
Phone: +47-66-77-8899
Fax: +47-66-77-8855

Poland – Warsaw
Phone: +48-22-611-59-30
Fax: +48-22-672-47-88

Portugal – Lisbon
Phone: +351-21-384-58-90
Fax: +351-21-387-71-72

Romania – Bucharest
Phone: +40-1-311-3479 + 3596
Fax: +40-1-312-0574

Russia – Moscow
Phone: +7-095-926-55-06...09
Fax: +7-095-926-55-05

Russia – St. Petersburg
Phone: +7-812-325-30-83
Fax: +7-812-325-32-88

Slovakia – Banská Bystrica
Phone: +421-88-415-20-11/12
Fax: +421-88-415-20-13

Slovenia – Ljubljana
Phone: +386-61-161-3270
Fax: +386-61-161-3240

South Africa – Midrand
Phone: +27-11-314-10-89
Fax: +27-11-314-19-10

Spain – Barcelona
Phone: +34-93-291-0330
Fax: +34-93-201-7879

Sweden – Järfälla
Phone: +46-8-580-833-00
Fax: +46-8-580-194-70

Switzerland – Steinach
Phone: +41-71-447-0447
Fax: +41-71-447-0444

Turkey – Istanbul
Phone: +90-212-281-8181...3
Fax: +90-212-281-8184

Ukraine – Kiev
Phone: +38-044-238-6595
Fax: +38-044-238-6596

Raychem
U.S.A. – Menlo Park, CA
Phone: +1-800-227-7040
+1-650-361-6900
Fax: +1-800-611-2323
+1-650-361-5579

Raychem Asia/Pacific
Japan – Kawasaki
Phone: +81-44-900-5110
Fax: +81-44-900-5140

Raychem Europe
United Kingdom – Dorcan
Swindon
Phone: +44-1793-528171
Fax: +44-1793-572516

Automation Services Group, Inc.
U.S.A. – West Palm Beach, FL
Phone: +1-561-848-6746
Fax: +1-561-848-6444

Micro-MaTch, AMP-LATCH, AMPLIMITE and AMP are trademarks. All other trademarks are the property of their respective owners.

AMP

ELCON

ATO

HTS

MACOM

MADISON

**AMP
NETCONNECT**

OEG

Potter & Brumfield

Raychem

SCHRACK

SIMEL

Mouser Electronics

Authorized Distributor

Click to View Pricing, Inventory, Delivery & Lifecycle Information:

[TE Connectivity:](#)

[8-188275-0](#)