

NL17SG07

Buffer with Open Drain Output

The NL17SG07 MiniGate™ is an advanced high-speed CMOS Buffer with Open Drain Output in ultra-small footprint.

The NL17SG07 input structures provides protection when voltages up to 5.5 V are applied with V_{CC} greater than or equal to 0.9 volts, otherwise the protection is up to 4.6 volts regardless of the supply voltage.

Features

- Wide Operating V_{CC} Range: 0.9 V to 3.6 V
- High Speed: $t_{PD} = 2.5$ ns (Typ) at $V_{CC} = 3.0$ V, $C_L = 15$ pF
- Low Power Dissipation: $I_{CC} = 0.5$ μ A (Max) at $T_A = 25^\circ$ C
- 5.5 V Overvoltage Tolerant (OVT) Input Pins ($V_{CC} \geq 0.9$ V)
- Ultra-Small Packages
- These are Pb-Free and Halide-Free Devices

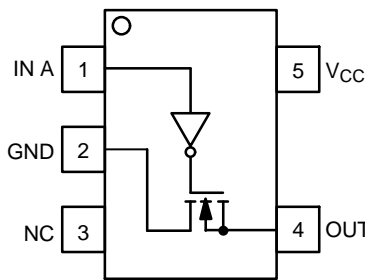

Figure 1. SOT-953
(Top View)

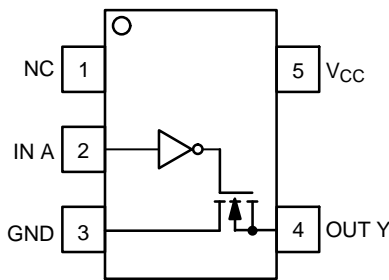

Figure 2. SC-88A
(Top View)

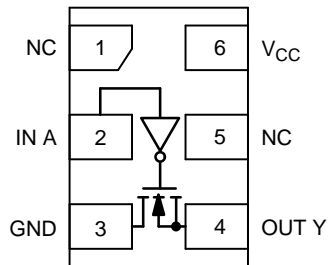

Figure 3. UDFN
(Top View)

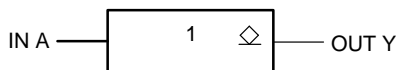

Figure 4. Logic Symbol



ON Semiconductor®

<http://onsemi.com>

MARKING DIAGRAMS



SOT-953
CASE 527AE

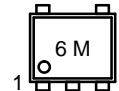

UDFN6
1.0 x 1.0
CASE 517BX



UDFN6
1.45 x 1.0
CASE 517AQ

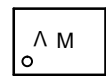

SC-88A
DF SUFFIX
CASE 419A

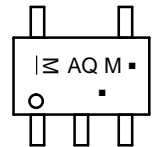

M = Date Code*

▪ = Pb-Free Package

(Note: Microdot may be in either location)

*Date Code orientation and/or position may vary depending upon manufacturing location.

PIN ASSIGNMENT

PIN	SOT-953	SC-88A	UDFN6
1	IN A	NC	NC
2	GND	IN A	IN A
3	NC	GND	GND
4	OUT Y	OUT Y	OUT Y
5	V_{CC}	V_{CC}	NC
6	-	-	V_{CC}

FUNCTION TABLE

Input A	Output Y
L	L
H	Z

ORDERING INFORMATION

See detailed ordering and shipping information in the package dimensions section on page 5 of this data sheet.

NL17SG07

MAXIMUM RATINGS

Symbol	Parameter	Value	Unit
V _{CC}	DC Supply Voltage	-0.5 to +5.5	V
V _{IN}	DC Input Voltage	V _{CC} ≥ 0.9 V V _{CC} < 0.9 V	V V
V _{OUT}	DC Output Voltage	-0.5 to V _{CC} + 0.5	V
I _{IK}	DC Input Diode Current	V _{IN} < GND	mA
I _{OK}	DC Output Diode Current	V _{OUT} < GND	mA
I _{OUT}	DC Output Source/Sink Current	±20	mA
I _{CC}	DC Supply Current per Supply Pin	±20	mA
I _{GND}	DC Ground Current per Ground Pin	±20	mA
T _{STG}	Storage Temperature Range	-65 to +150	°C
T _L	Lead Temperature, 1 mm from Case for 10 Seconds	260	°C
T _J	Junction Temperature Under Bias	+150	°C
MSL	Moisture Sensitivity	Level 1	
FR	Flammability Rating	Oxygen Index: 28 to 34	UL 94 V-0 @ 0.125 in
V _{ESD}	ESD Withstand Voltage	Human Body Model (Note 2) Machine Model (Note 3)	V V
I _{LATCHUP}	Latch-up Performance above V _{CC} and below GND at 125°C (Note 4)	±75	mA

Stresses exceeding those listed in the Maximum Ratings table may damage the device. If any of these limits are exceeded, device functionality should not be assumed, damage may occur and reliability may be affected.

1. Measured with minimum pad spacing on an FR4 board, using 10 mm-by-1 inch, 2-ounce copper trace with no air flow.
2. Tested to EIA/JESD22-A114-A.
3. Tested to EIA/JESD22-A115-A.
4. Tested to EIA/JESD78.

RECOMMENDED OPERATING CONDITIONS

Symbol	Characteristics	Min	Max	Unit
V _{CC}	Positive DC Supply Voltage	0.9	3.6	V
V _{IN}	Digital Input Voltage	0.0	3.6	V
V _{OUT}	Output Voltage	0.0	V _{CC}	V
	Output at High or Low State	0.0	3.6	
	Tri-State Mode (Note 5)	0.0	3.6	
	Power-Down Mode (V _{CC} = 0 V)	0.0	3.6	
T _A	Operating Temperature Range	-55	+125	°C
Δt / ΔV	Input Transition Rise or Fall Rate	0	10	ns/V
	V _{CC} = 3.3 V ± 0.3 V			

Functional operation above the stresses listed in the Recommended Operating Ranges is not implied. Extended exposure to stresses beyond the Recommended Operating Ranges limits may affect device reliability.

5. Applicable to devices with outputs that may be tri-stated.

NL17SG07

DC ELECTRICAL CHARACTERISTICS

Symbol	Parameter	Condition	V _{CC} (V)	T _A = 25°C			-55°C ≤ T _A ≤ 125°C		Unit	
				Min	Typ	Max	Min	Max		
V _{IH}	High-Level Input Voltage		0.9	V _{CC}			V _{CC}		V	
			1.1 to 1.3	0.70 x V _{CC}			0.70 x V _{CC}			
			1.4 to 1.6	0.65 x V _{CC}			0.65 x V _{CC}			
			1.65 to 1.95	0.65 x V _{CC}			0.65 x V _{CC}			
			2.3 to 2.7	1.7			1.7			
			3.0 to 3.6	2.0			2.0			
V _{IL}	Low-Level Input Voltage		0.9			GND		GND	V	
			1.1 to 1.3			0.30 x V _{CC}		0.30 x V _{CC}		
			1.4 to 1.6			0.35 x V _{CC}		0.35 x V _{CC}		
			1.65 to 1.95			0.35 x V _{CC}		0.35 x V _{CC}		
			2.3 to 2.7			0.7		0.7		
			3.0 to 3.6			0.8		0.8		
V _{OL}	Low-Level Output Voltage	V _{IN} = V _{IH} or V _{IL}	I _{OL} = 20 μA	0.9			0.1		0.1	V
			I _{OL} = 0.3 mA	1.1 to 1.3			0.25 x V _{CC}		0.25 x V _{CC}	
			I _{OL} = 1.7 mA	1.4 to 1.6			0.25 x V _{CC}		0.25 x V _{CC}	
			I _{OL} = 3.0 mA	1.65 to 1.95			0.45		0.45	
			I _{OL} = 4.0 mA	2.3 to 2.7			0.4		0.4	
			I _{OL} = 8.0 mA	3.0 to 3.6			0.4		0.4	
I _{IN}	Input Leakage Current	0 ≤ V _{IN} ≤ 3.6 V	0 to 3.6			±0.1		±1.0	μA	
I _{CC}	Quiescent Supply Current	V _{IN} = V _{CC} or GND	3.6			0.5		10	μA	

Product parametric performance is indicated in the Electrical Characteristics for the listed test conditions, unless otherwise noted. Product performance may not be indicated by the Electrical Characteristics if operated under different conditions.

NL17SG07

AC ELECTRICAL CHARACTERISTICS (Input $t_r = t_f = 3.0$ ns)

Symbol	Parameter	Test Condition	V_{CC} (V)	$T_A = 25^\circ\text{C}$			$T_A = -55^\circ\text{C to } +125^\circ\text{C}$		Unit		
				Min	Typ	Max	Min	Max			
t_{PZL}	Propagation Delay, Enable Time, A to Y	$C_L = 10$ pF, $R_1 = R_L = 5$ k Ω	0.9	–	12	–	–	–	ns		
			1.1 to 1.3	–	5.5	6.8	–	8.8			
			1.4 to 1.6	–	4.0	5.7	–	7.3			
			1.65 to 1.95	–	3.3	3.9	–	5.9			
			2.3 to 2.7	–	2.7	3.3	–	4.5			
			3.0 to 3.6	–	2.4	2.9	–	3.7			
		$C_L = 15$ pF, $R_1 = R_L = 5$ k Ω	0.9	–	12.5	–	–	–	ns		
			1.1 to 1.3	–	5.8	7.0	–	9.0			
			1.4 to 1.6	–	4.1	6.0	–	7.4			
			1.65 to 1.95	–	3.4	4.0	–	6.2			
			2.3 to 2.7	–	2.8	3.4	–	4.6			
		$C_L = 30$ pF, $R_1 = R_L = 5$ k Ω	0.9	–	13.2	–	–	–	ns		
			1.1 to 1.3	–	6.2	7.4	–	9.4			
			1.4 to 1.6	–	4.5	6.2	–	7.6			
			1.65 to 1.95	–	3.5	4.2	–	6.4			
			2.3 to 2.7	–	3.0	3.6	–	4.7			
		t_{PLZ}	Propagation Delay, Disable Time, A to Y	$C_L = 10$ pF, $R_1 = R_L = 5$ k Ω	0.9	–	8.0	–	–	–	ns
					1.1 to 1.3	–	6.5	10.9	–	11.5	
1.4 to 1.6	–				5.2	7.2	–	8.3			
1.65 to 1.95	–				4.9	7.0	–	7.8			
2.3 to 2.7	–				3.8	6.5	–	7.3			
$C_L = 15$ pF, $R_1 = R_L = 5$ k Ω	0.9			–	11.1	–	–	–	ns		
	1.1 to 1.3			–	9.0	13.4	–	14			
	1.4 to 1.6			–	7.9	10	–	10.8			
	1.65 to 1.95			–	7.6	9.5	–	10.5			
	2.3 to 2.7			–	6.3	7.8	–	10			
$C_L = 30$ pF, $R_1 = R_L = 5$ k Ω	0.9			–	16.2	–	–	–	ns		
	1.1 to 1.3			–	14	18.4	–	20			
	1.4 to 1.6			–	13	15	–	16			
	1.65 to 1.95			–	12.5	14.5	–	15.8			
	2.3 to 2.7			–	11.2	13.5	–	15.4			
C_{IN}	Input Capacitance				0 to 3.6	–	3	–	–	–	pF
					C_{PD}	Power Dissipation Capacitance (Note 6)		0.9 to 3.6	–	4	

6. C_{PD} is defined as the value of the internal equivalent capacitance which is calculated from the dynamic operating current consumption without load. Average operating current can be obtained by the equation: $I_{CC(OPR)} = C_{PD} \cdot V_{CC} \cdot f_{in} + I_{CC}$. C_{PD} is used to determine the no-load dynamic power consumption; $P_D = C_{PD} \cdot V_{CC}^2 \cdot f_{in} + I_{CC} \cdot V_{CC}$.

NL17SG07

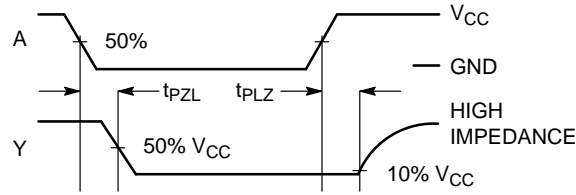
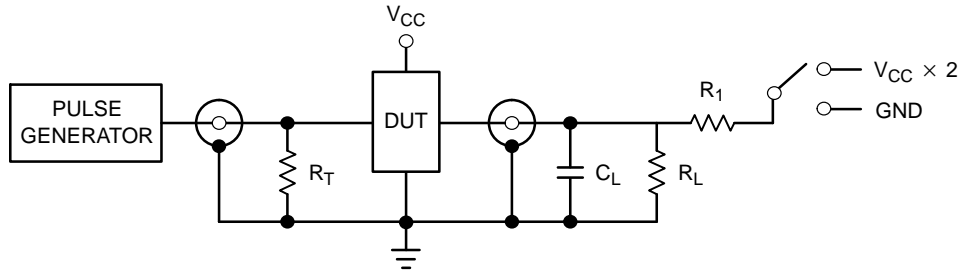

Figure 5. Switching Waveform



Test	Switch
t _{PZL}	V _{CC} x 2
t _{PLZ}	V _{CC} x 2

Figure 6. Test Circuit

ORDERING INFORMATION

Device	Package	Shipping [†]
NL17SG07P5T5G	SOT-953 (Pb-Free)	8000 / Tape & Reel
NL17SG07DFT2G	SC-88A (Pb-Free)	3000 / Tape & Reel
NL17SG07AMUTCG*	UDFN6 1.45x1 mm (Pb-Free)	3000 / Tape & Reel
NL17SG07CMUTCG*	UDFN6 1x1 mm (Pb-Free)	3000 / Tape & Reel

[†]For information on tape and reel specifications, including part orientation and tape sizes, please refer to our Tape and Reel Packaging Specifications Brochure, BRD8011/D.

*In Development

NL17SG07

PACKAGE DIMENSIONS

SOT-953
CASE 527AE
ISSUE E

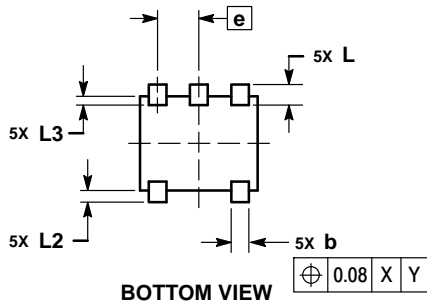
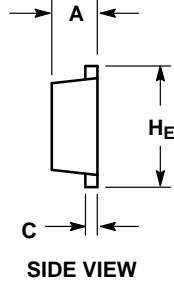
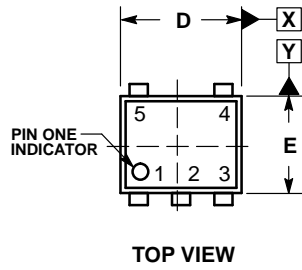

NOTES:

1. DIMENSIONING AND TOLERANCING PER ASME Y14.5M, 1994.
2. CONTROLLING DIMENSION: MILLIMETERS
3. MAXIMUM LEAD THICKNESS INCLUDES LEAD FINISH. MINIMUM LEAD THICKNESS IS THE MINIMUM THICKNESS OF THE BASE MATERIAL.
4. DIMENSIONS D AND E DO NOT INCLUDE MOLD FLASH, PROTRUSIONS, OR GATE BURRS.

MILLIMETERS			
DIM	MIN	NOM	MAX
A	0.34	0.37	0.40
b	0.10	0.15	0.20
C	0.07	0.12	0.17
D	0.95	1.00	1.05
E	0.75	0.80	0.85
e	0.35 BSC		
H _E	0.95	1.00	1.05
L	0.175 REF		
L2	0.05	0.10	0.15
L3	---	---	0.15

SOLDERING FOOTPRINT*

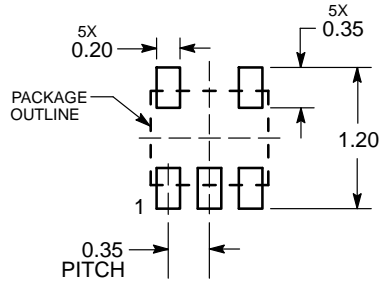

DIMENSIONS: MILLIMETERS

*For additional information on our Pb-Free strategy and soldering details, please download the ON Semiconductor Soldering and Mounting Techniques Reference Manual, SOLDERRM/D.

NL17SG07

PACKAGE DIMENSIONS

UDFN6 1.0x1.0, 0.35P
CASE 517BX
ISSUE O



NOTES:

1. DIMENSIONING AND TOLERANCING PER ASME Y14.5M, 1994.
2. CONTROLLING DIMENSION: MILLIMETERS.
3. DIMENSION b APPLIES TO PLATED TERMINAL AND IS MEASURED BETWEEN 0.15 AND 0.20 MM FROM TERMINAL TIP.
4. PACKAGE DIMENSIONS EXCLUSIVE OF BURRS AND MOLD FLASH.

DIM	MILLIMETERS	
	MIN	MAX
A	0.45	0.55
A1	0.00	0.05
A3	0.13 REF	
b	0.12	0.22
D	1.00 BSC	
E	1.00 BSC	
e	0.35 BSC	
L	0.25	0.35
L1	0.30	0.40

RECOMMENDED SOLDERING FOOTPRINT*

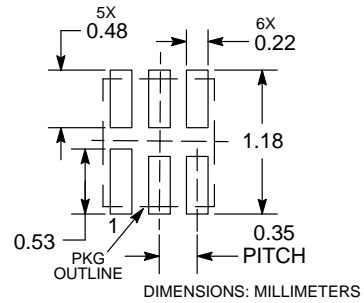

*For additional information on our Pb-Free strategy and soldering details, please download the ON Semiconductor Soldering and Mounting Techniques Reference Manual, SOLDERRM/D.

NL17SG07

PACKAGE DIMENSIONS

UDFN6 1.45x1.0, 0.5P
CASE 517AQ
ISSUE O

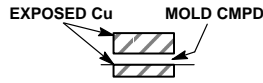
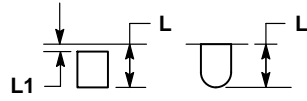

- NOTES:
1. DIMENSIONING AND TOLERANCING PER ASME Y14.5M, 1994.
 2. CONTROLLING DIMENSION: MILLIMETERS.
 3. DIMENSION b APPLIES TO PLATED TERMINAL AND IS MEASURED BETWEEN 0.15 AND 0.30 mm FROM THE TERMINAL TIP.

MILLIMETERS		
DIM	MIN	MAX
A	0.45	0.55
A1	0.00	0.05
A2	0.07 REF	
b	0.20	0.30
D	1.45 BSC	
E	1.00 BSC	
e	0.50 BSC	
L	0.30	0.40
L1	---	0.15

MOUNTING FOOTPRINT

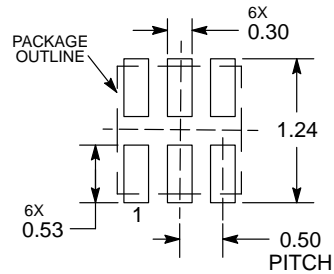

DIMENSIONS: MILLIMETERS

*For additional information on our Pb-Free strategy and soldering details, please download the ON Semiconductor Soldering and Mounting Techniques Reference Manual, SOLDERRM/D.

NL17SG07

PACKAGE DIMENSIONS

SC-88A (SC-70-5/SOT-353)
CASE 419A-02
ISSUE L

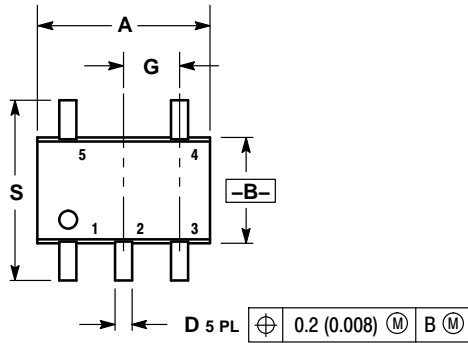

NOTES:

1. DIMENSIONING AND TOLERANCING PER ANSI Y14.5M, 1982.
2. CONTROLLING DIMENSION: INCH.
3. 419A-01 OBSOLETE. NEW STANDARD 419A-02.
4. DIMENSIONS A AND B DO NOT INCLUDE MOLD FLASH, PROTRUSIONS, OR GATE BURRS.

DIM	INCHES		MILLIMETERS	
	MIN	MAX	MIN	MAX
A	0.071	0.087	1.80	2.20
B	0.045	0.053	1.15	1.35
C	0.031	0.043	0.80	1.10
D	0.004	0.012	0.10	0.30
G	0.026 BSC		0.65 BSC	
H	---	0.004	---	0.10
J	0.004	0.010	0.10	0.25
K	0.004	0.012	0.10	0.30
N	0.008 REF		0.20 REF	
S	0.079	0.087	2.00	2.20

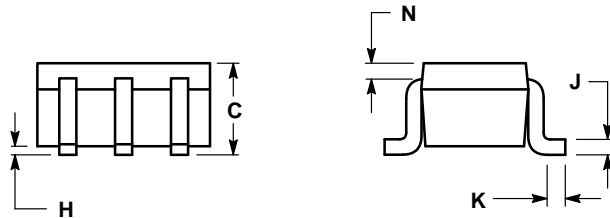

SOLDER FOOTPRINT*

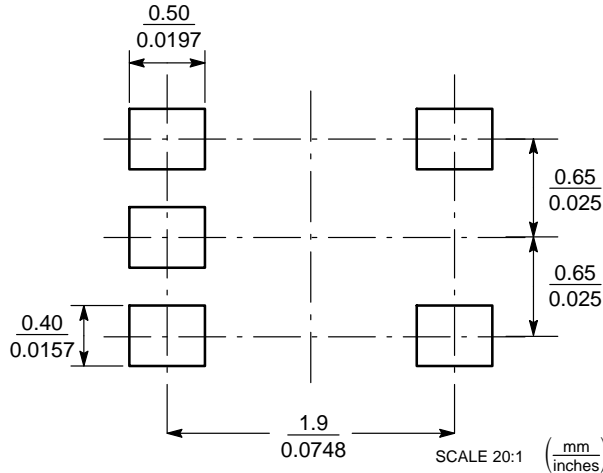

*For additional information on our Pb-Free strategy and soldering details, please download the ON Semiconductor Soldering and Mounting Techniques Reference Manual, SOLDERRM/D.

MiniGate is a trademark of Semiconductor Components Industries, LLC (SCILLC).

ON Semiconductor and are registered trademarks of Semiconductor Components Industries, LLC (SCILLC). SCILLC owns the rights to a number of patents, trademarks, copyrights, trade secrets, and other intellectual property. A listing of SCILLC's product/patent coverage may be accessed at www.onsemi.com/site/pdf/Patent-Marking.pdf. SCILLC reserves the right to make changes without further notice to any products herein. SCILLC makes no warranty, representation or guarantee regarding the suitability of its products for any particular purpose, nor does SCILLC assume any liability arising out of the application or use of any product or circuit, and specifically disclaims any and all liability, including without limitation special, consequential or incidental damages. "Typical" parameters which may be provided in SCILLC data sheets and/or specifications can and do vary in different applications and actual performance may vary over time. All operating parameters, including "Typicals" must be validated for each customer application by customer's technical experts. SCILLC does not convey any license under its patent rights nor the rights of others. SCILLC products are not designed, intended, or authorized for use as components in systems intended for surgical implant into the body, or other applications intended to support or sustain life, or for any other application in which the failure of the SCILLC product could create a situation where personal injury or death may occur. Should Buyer purchase or use SCILLC products for any such unintended or unauthorized application, Buyer shall indemnify and hold SCILLC and its officers, employees, subsidiaries, affiliates, and distributors harmless against all claims, costs, damages, and expenses, and reasonable attorney fees arising out of, directly or indirectly, any claim of personal injury or death associated with such unintended or unauthorized use, even if such claim alleges that SCILLC was negligent regarding the design or manufacture of the part. SCILLC is an Equal Opportunity/Affirmative Action Employer. This literature is subject to all applicable copyright laws and is not for resale in any manner.

PUBLICATION ORDERING INFORMATION

LITERATURE FULFILLMENT:
Literature Distribution Center for ON Semiconductor
P.O. Box 5163, Denver, Colorado 80217 USA
Phone: 303-675-2175 or 800-344-3860 Toll Free USA/Canada
Fax: 303-675-2176 or 800-344-3867 Toll Free USA/Canada
Email: orderlit@onsemi.com

N. American Technical Support: 800-282-9855 Toll Free
USA/Canada
Europe, Middle East and Africa Technical Support:
Phone: 421 33 790 2910
Japan Customer Focus Center
Phone: 81-3-5817-1050

ON Semiconductor Website: www.onsemi.com
Order Literature: <http://www.onsemi.com/orderlit>
For additional information, please contact your local Sales Representative

Mouser Electronics

Authorized Distributor

Click to View Pricing, Inventory, Delivery & Lifecycle Information:

[ON Semiconductor:](#)

[NL17SG07DFT2G](#)