

**GENERAL DESCRIPTION**

The SPX3940 is a 1A, accurate voltage regulator with a low drop out voltage of 280mV (typical) at 1A.

These regulators are specifically designed for low voltage applications that require a low dropout voltage and a fast transient response. They are fully fault protected against over-current, reverse battery, and positive and negative voltage transients.

The SPX3940 is offered in 3-pin SOT223 and TO-263 packages. For a 3A version, refer to the SPX29300 data sheet.

**APPLICATIONS**

- **Power Supplies**
- **LCD Monitors**
- **Portable Instrumentation**
- **Medical and Industrial Equipments**

**FEATURES**

- **Guaranteed 1.5A Peak Current**
- **1% Output Accuracy SPX3940A**
- **Low Quiescent Current**
- **Low Dropout Voltage of 280mV at 1A**
- **Extremely Tight Load and Line Regulation**
- **Extremely Fast Transient Response**
- **Reverse-battery Protection**
- **Internal Thermal Protection**
- **Internal Short Circuit Current Limit**
- **Replacement for LM3940**
- **Standard SOT223 & TO-263 packages**

**TYPICAL APPLICATION DIAGRAM**

Fig. 1: SPX3940 Application Diagram – Fixed Output Linear Regulator



**ABSOLUTE MAXIMUM RATINGS**

These are stress ratings only and functional operation of the device at these ratings or any other above those indicated in the operation sections of the specifications below is not implied. Exposure to absolute maximum rating conditions for extended periods of time may affect reliability.

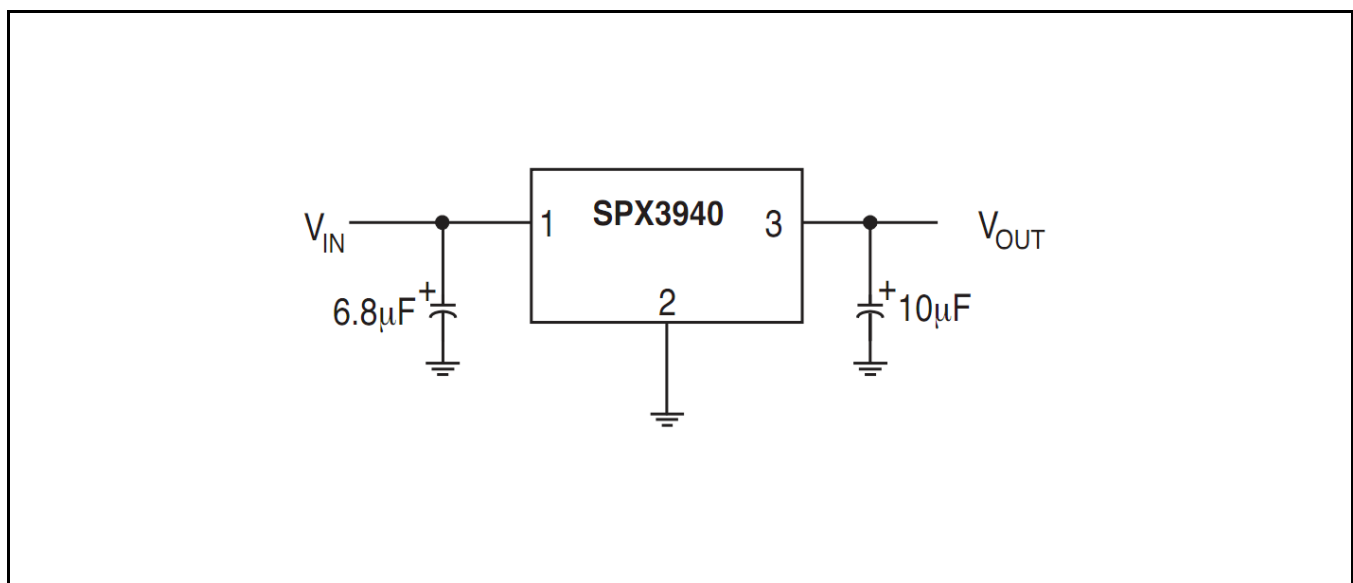
Input Voltage  $V_{IN}$  ..... 20V<sup>1</sup>  
 Storage Temperature ..... -65°C to 150°C  
 Lead Temperature (Soldering, 5 sec) ..... 260°C

**OPERATING RATINGS**

Input Voltage  $V_{IN}$  ..... 16V  
 Junction Temperature Range ..... -40°C to 125°C  
 Packages Thermal Resistance  
     SOT-223 Junction to Case (at  $T_A$ ) ..... 15°C/W  
     SOT-223 Junction to Ambient ..... 62.3°C/W  
     TO-263 Junction to Case (at  $T_A$ ) ..... 3°C/W  
     TO-263 Junction to Ambient ..... 31.4°C/W

Note 1: Maximum positive supply voltage of 20V must be of limited duration (<100ms) and duty cycle (<1%). The maximum continuous supply voltage is 16V.

**ELECTRICAL SPECIFICATIONS**

Specifications with standard type are for an Operating Ambient Temperature of  $T_A = 25^\circ\text{C}$  only; limits applying over the full Operating Junction Temperature range are denoted by a “•”. Minimum and Maximum limits are guaranteed through test, design, or statistical correlation. Typical values represent the most likely parametric norm at  $T_A = 25^\circ\text{C}$ , and are provided for reference purposes only. Unless otherwise indicated,  $V_{IN} = V_{IN} + 1V$ ,  $I_{OUT} = 10\text{mA}$ ,  $C_{IN} = 6.8\mu\text{F}$ ,  $C_{OUT} = 10\mu\text{F}$ ,  $T_A = 25^\circ\text{C}$ .

Parameter	Min.	Typ.	Max.	Units	Conditions	
<b>1.8V version</b>						
Output Voltage - SPX3940A (1%)	1.782	1.8	1.818	V	$I_{OUT}=10\text{mA}$ $10\text{mA} \leq I_{OUT} \leq 1\text{A}$ , $6V \leq V_{IN} \leq 16V$	
	1.755	1.8	1.845			
Output Voltage - SPX3940 (2%)	1.764	1.8	1.836	V		
	1.737	1.8	1.863			
<b>2.5V version</b>						
Output Voltage - SPX3940A (1%)	2.475	2.5	2.525	V		$I_{OUT}=10\text{mA}$ $10\text{mA} \leq I_{OUT} \leq 1\text{A}$ , $6V \leq V_{IN} \leq 16V$
	2.437	2.5	2.563			
Output Voltage - SPX3940 (2%)	2.450	2.5	2.550	V		
	2.412	2.5	2.588			
<b>3.3V version</b>						
Output Voltage - SPX3940A (1%)	3.267	3.3	3.333	V	$I_{OUT}=10\text{mA}$ $10\text{mA} \leq I_{OUT} \leq 1\text{A}$ , $6V \leq V_{IN} \leq 16V$	
	3.217	3.3	3.383			
Output Voltage - SPX3940 (2%)	3.234	3.3	3.366	V		
	3.184	3.3	3.416			
<b>5.0V version</b>						
Output Voltage - SPX3940A (1%)	4.950	5.0	5.050	V		$I_{OUT}=10\text{mA}$ $10\text{mA} \leq I_{OUT} \leq 1\text{A}$ , $6V \leq V_{IN} \leq 16V$
	4.875	5.0	5.125			
Output Voltage - SPX3940 (2%)	4.900	5.0	5.100	V		
	4.825	5.0	5.175			
<b>All Voltage Options</b>						
Line Regulation		0.2	1.0	%	$I_{OUT}=10\text{mA}$ , $(V_{OUT} + 1V) \leq V_{IN} \leq 16V$	
Load Regulation		0.3	1.5	%	$V_{IN} = V_{OUT} + 1V$ , $10\text{mA} \leq I_{OUT} \leq 1\text{A}$	
$\frac{\Delta V}{\Delta T}$ - Output Voltage temperature Coefficient		20	100	ppm/°C	•	
Dropout Voltage <sup>2</sup> (except 1.8V version)		70	200	mV	• $I_{OUT}=100\text{mA}$	
		280	550	mV	• $I_{OUT}=1\text{A}$	
Ground Current <sup>3</sup>		12	25	mA	• $I_{OUT}=750\text{mA}$ , $V_{IN} = V_{OUT} + 1V$	
		18		mA	$I_{OUT}=1\text{A}$	
$I_{GNDDO}$ Ground Pin Current at Dropout		1.2		mA	$V_{IN} = 0.1V$ less than specified $V_{OUT}$ $I_{OUT}=10\text{mA}$ ,	
Current Limit	1.5	2.2		A	$V_{OUT} = 0V^4$	
Output Noise Voltage		400		$\mu\text{V}_{RMS}$	10Hz-100KHz, $I_L=100\text{mA}$ , $C_L=10\mu\text{F}$	
		260		$\mu\text{V}_{RMS}$	10Hz-100KHz, $I_L=100\text{mA}$ , $C_L=33\mu\text{F}$	

Note 2: Dropout voltage is defined as the input to output differential when the output voltage drops to 99% of its normal value.

Note 3: Ground pin current is the regulator quiescent current. The total current drawn from the source is the sum of the load current to the ground current.

Note 4:  $V_{IN} = V_{OUT(NOMINAL)} + 1V$ . For example, use  $V_{IN} = 4.3V$  for a 3.3V regulator. Employ pulse-testing procedures to minimize temperature rise.

**BLOCK DIAGRAM**

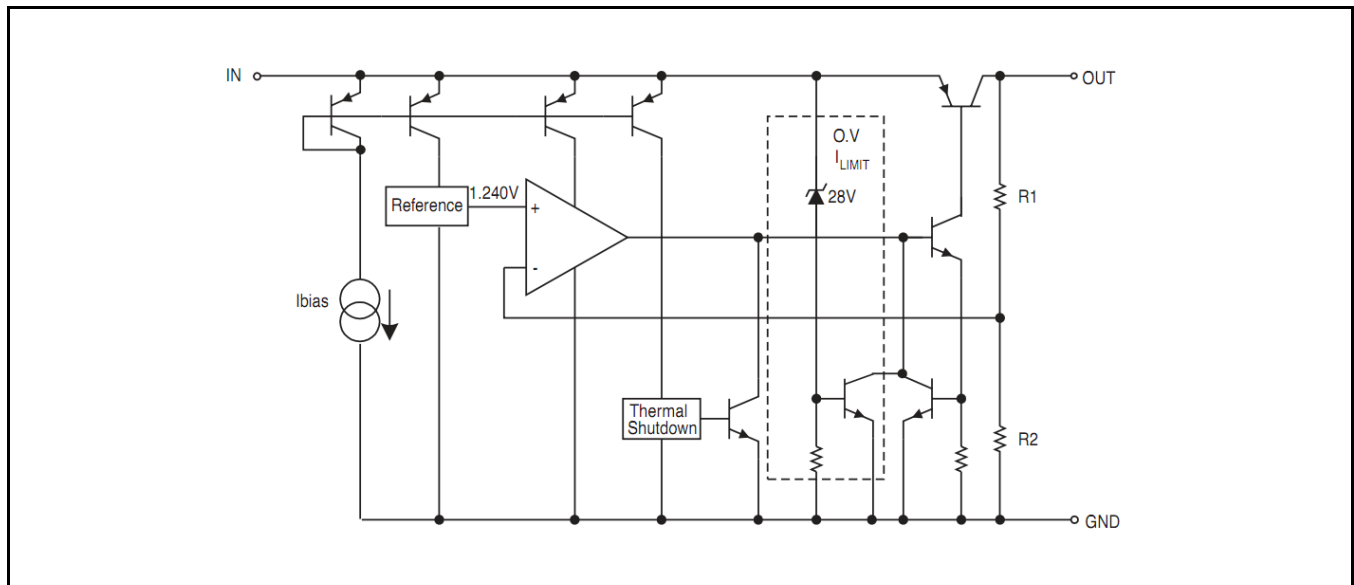

Fig. 2: SPX3940 Block Diagram

**PIN ASSIGNMENT**

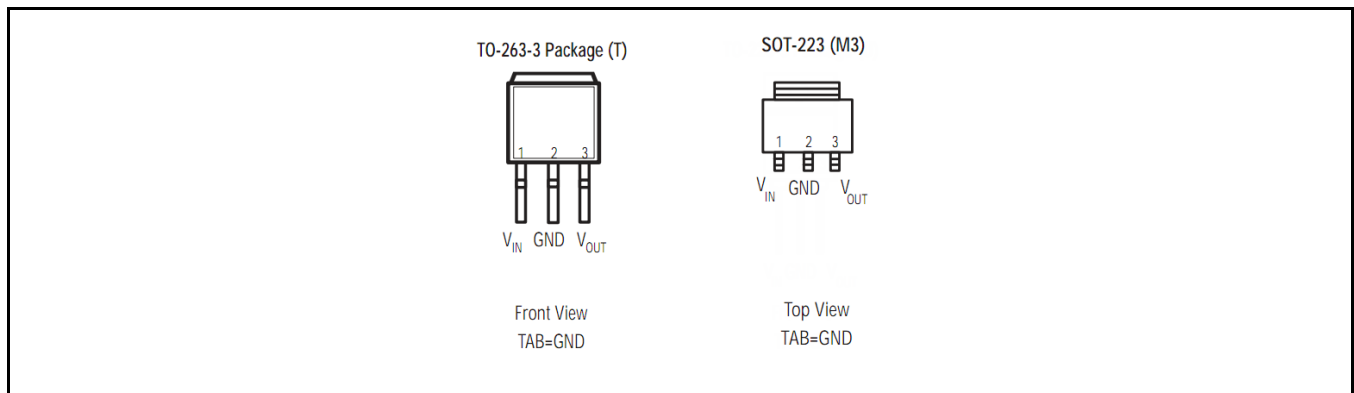

Fig. 3: SPX3940 Pin Assignment



**ORDERING INFORMATION**

Part Number	Temperature Range	Marking	Package	Packing Quantity	Note 1	Note 2
SPX3940AM3-L-1-8	-40°C ≤ T <sub>j</sub> ≤ +125°C	3940A	3-pin SOT-223	2.5K/Tape & Reel	Lead Free	1.8V Output Voltage – 1%
SPX3940AM3-L-1-8/TR		18YYWWL XXX		Bulk		
SPX3940AM3-L-2-5	-40°C ≤ T <sub>j</sub> ≤ +125°C	3940A	3-pin SOT-223	2.5K/Tape & Reel	Lead Free	2.5V Output Voltage – 1%
SPX3940AM3-L-2-5/TR		25YYWWL XXX		Bulk		
SPX3940AM3-L-3-3	-40°C ≤ T <sub>j</sub> ≤ +125°C	3940A	3-pin SOT-223	2.5K/Tape & Reel	Lead Free	3.3V Output Voltage – 1%
SPX3940AM3-L-3-3/TR		33YYWWL XXX		Bulk		
SPX3940AM3-L-5-0	-40°C ≤ T <sub>j</sub> ≤ +125°C	3940A	3-pin SOT-223	2.5K/Tape & Reel	Lead Free	5.0V Output Voltage – 1%
SPX3940AM3-L-5-0/TR		50YYWWL XXX		Bulk		
SPX3940AT-L-1-8	-40°C ≤ T <sub>j</sub> ≤ +125°C	SPX3940AT	3-pin TO-263	500/Tape & Reel	Lead Free	1.8V Output Voltage – 1%
SPX3940AT-L-1-8/TR		18YYWWLX		Bulk		
SPX3940AT-L-3-3	-40°C ≤ T <sub>j</sub> ≤ +125°C	SPX3940AT	3-pin TO-263	500/Tape & Reel	Lead Free	3.3V Output Voltage – 1%
SPX3940AT-L-3-3/TR		33YYWWLX		Bulk		
SPX3940AT-L-5-0	-40°C ≤ T <sub>j</sub> ≤ +125°C	SPX3940AT	3-pin TO-263	500/Tape & Reel	Lead Free	5.0V Output Voltage – 1%
SPX3940AT-L-5-0/TR		50YYWWLX		Bulk		
SPX3940M3-L-2-5	-40°C ≤ T <sub>j</sub> ≤ +125°C	3940M3	3-pin SOT-223	2.5K/Tape & Reel	Lead Free	2.5V Output Voltage – 2%
SPX3940M3-L-2-5/TR		25YYWWL		Bulk		
SPX3940M3-L-3-3	-40°C ≤ T <sub>j</sub> ≤ +125°C	3940M3	3-pin SOT-223	2.5K/Tape & Reel	Lead Free	3.3V Output Voltage – 2%
SPX3940M3-L-3-3/TR		33YYWWL		Bulk		
SPX3940M3-L-5-0	-40°C ≤ T <sub>j</sub> ≤ +125°C	3940M3	3-pin SOT-223	2.5K/Tape & Reel	Lead Free	5.0V Output Voltage – 2%
SPX3940M3-L-5-0/TR		50YYWWL		Bulk		
SPX3940T-L-3-3	-40°C ≤ T <sub>j</sub> ≤ +125°C	SPX3940T	3-pin TO-263	500/Tape & Reel	Lead Free	3.3V Output Voltage – 2%
SPX3940T-L-3-3/TR		33YYWWLX		Bulk		
SPX3940T-L-5-0	-40°C ≤ T <sub>j</sub> ≤ +125°C	SPX3940T	3-pin TO-263	500/Tape & Reel	Lead Free	5.0V Output Voltage – 2%
SPX3940T-L-5-0/TR		33YYWWLX		Bulk		

“YY” = Year – “WW” = Work Week – “X” = Lot Number – when applicable.

**TYPICAL PERFORMANCE CHARACTERISTICS**

Schematic and BOM from Application Information section of this datasheet.

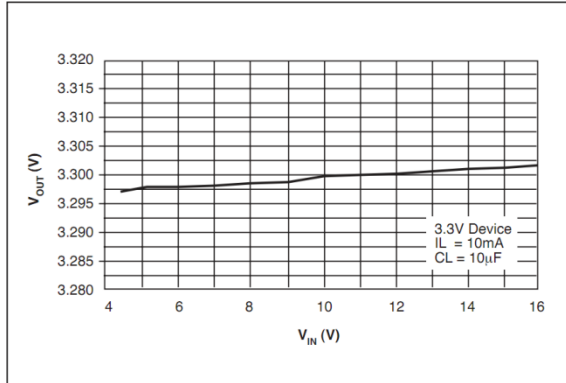

Fig. 4: Line Regulation

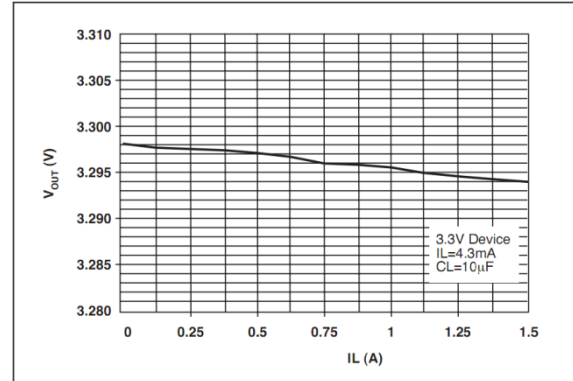

Fig. 5: Load Regulation

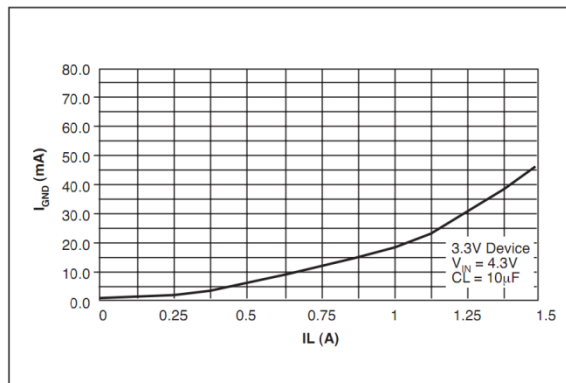

Fig. 6: Ground Current vs Load Current

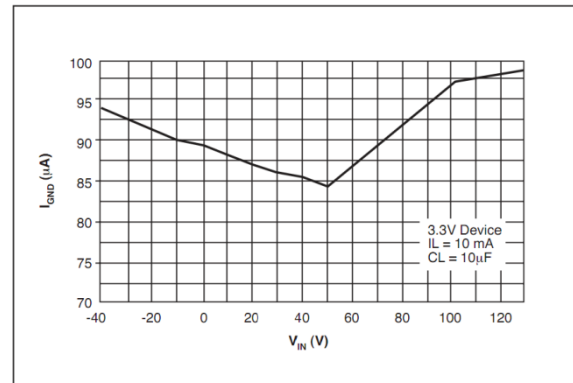

Fig. 7: Ground Current vs Input Voltage

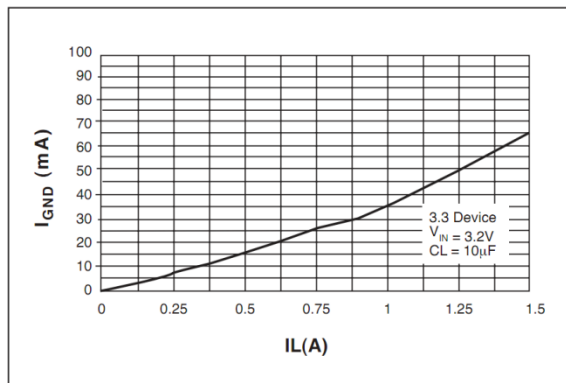

Fig. 8: Ground Current vs Load Current in Dropout

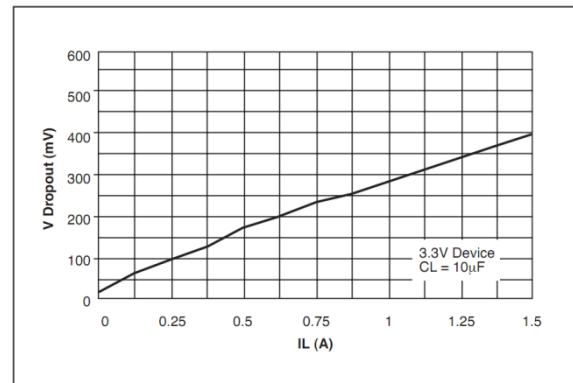

Fig. 9: Dropout Voltage vs Load Current

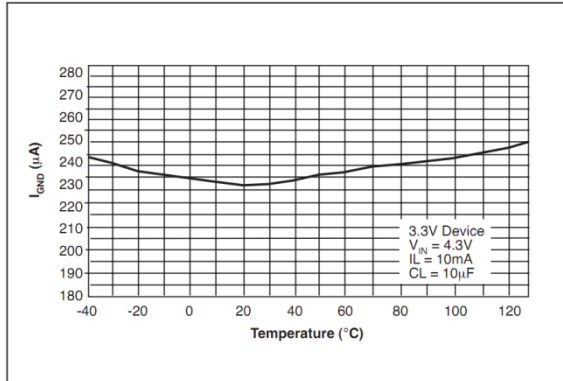

Fig. 10: Ground Current vs Temperature  
 $I_{LOAD}=100mA$

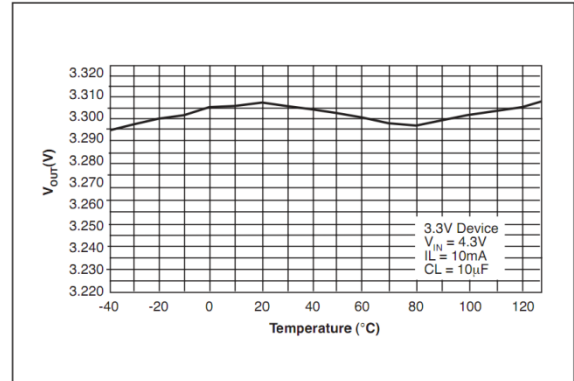

Fig. 11: Output Voltage vs Temperature  
 $I_{LOAD}=100mA$

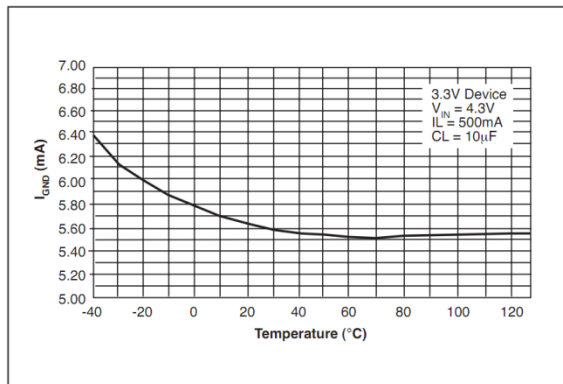

Fig. 12: Ground Current vs Temperature  
 $I_{LOAD}=500mA$

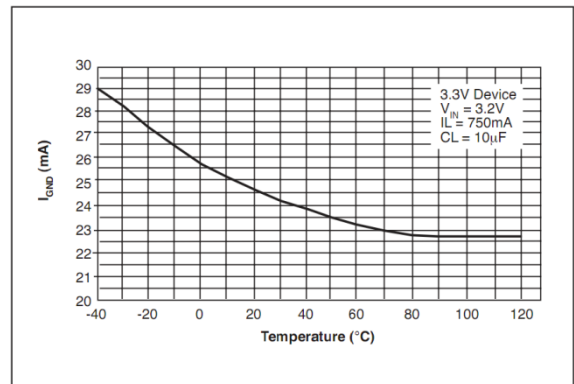

Fig. 13: Ground Current vs Temperature Dropout,  $I_{LOAD}=750mA$

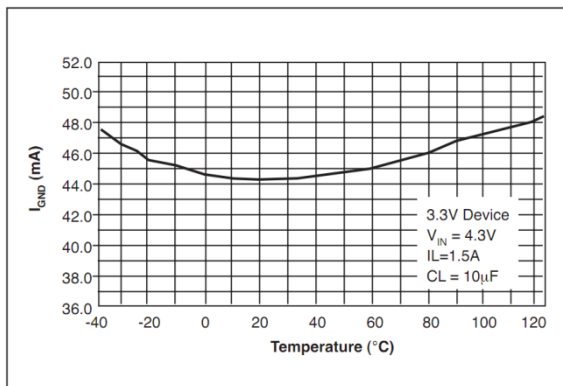

Fig. 14: Ground Current vs Temperature  
 $I_{LOAD}=1.5A$

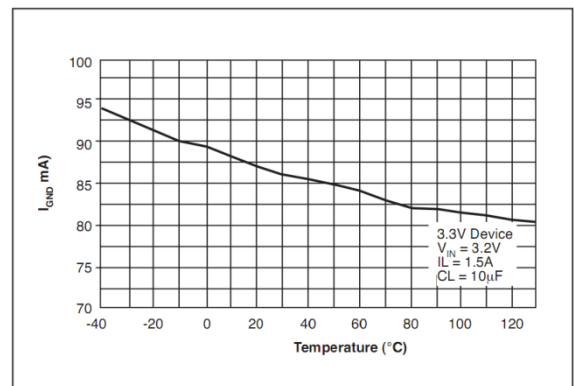

Fig. 15: Ground Current vs Temperature Dropout,  $I_{LOAD}=1.5A$

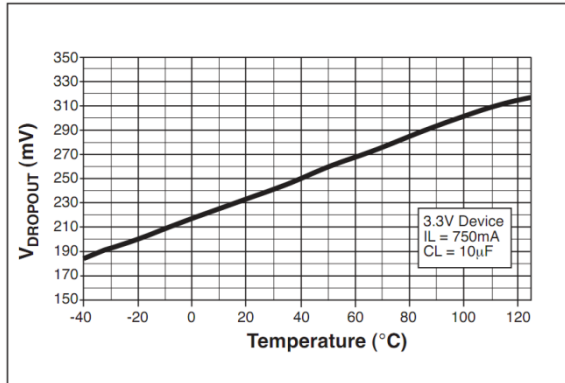

Fig. 16: Dropout Voltage vs Temperature  
I<sub>LOAD</sub>=750mA

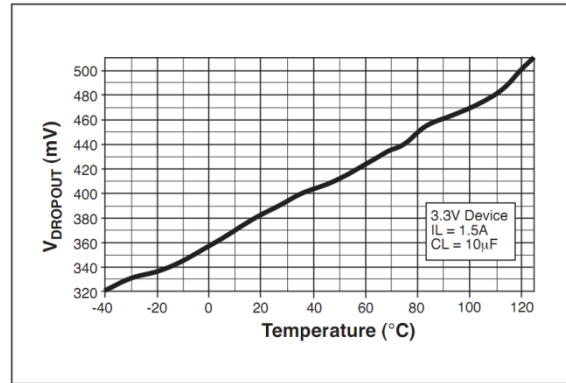

Fig. 17: Dropout Voltage vs Temperature  
I<sub>LOAD</sub>=1.5A

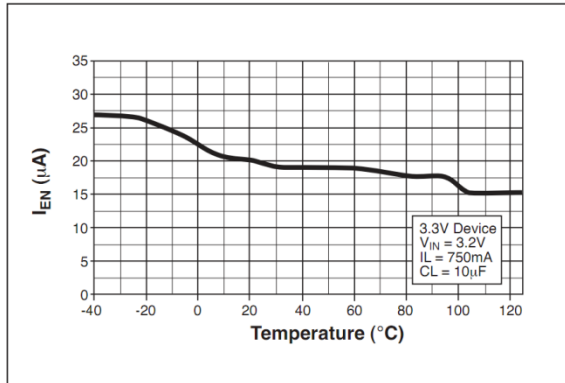

Fig. 18: Enable Current vs Temperature  
V<sub>EN</sub>=16V

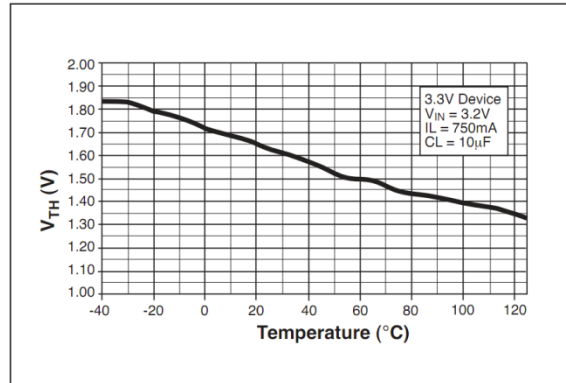

Fig. 19: Enable Threshold vs Temperature

**1A Low Dropout Voltage Regulator**

**THEORY OF OPERATION**

The SPX3940 incorporates protection against over-current faults, reversed load insertion, over temperature operation, and positive and negative transient voltage.

**THERMAL CONSIDERATIONS**

Although the SPX3940 offers limiting circuitry for overload conditions, it is still necessary to insure that the maximum junction temperature is not exceeded in the application. Heat will flow through the lowest resistance path, the junction-to-case path. In order to insure the best thermal flow of the component, proper mounting is required. Consult heatsink manufacturer for thermal resistance and design of heatsink.

**TO-220 Design Example:**

Assume that  $V_{IN} = 10V$ ,  $V_{OUT} = 5V$ ,  $I_{OUT} = 1.5A$ ,  $T_A = 50^{\circ}C/W$ ,  $\theta_{HA} = 1^{\circ}C/W$ ,  $\theta_{CH} = 2^{\circ}C/W$ , and  $\theta_{JC} = 3^{\circ}C/W$ .

Where  $T_A$  = ambient temperature

$\theta_{HA}$  = heatsink to ambient thermal resistance

$\theta_{CH}$  = case to heatsink thermal resistance

$\theta_{JC}$  = junction to case thermal resistance

The power calculated under these conditions is:

$$P_D = (V_{IN} - V_{OUT}) * I_{OUT} = 7.5W.$$

And the junction temperature is calculated as

$$T_J = T_A + P_D * (\theta_{HA} + \theta_{CH} + \theta_{JC}) \text{ or}$$

$$T_J = 50 + 7.5 * (1 + 2 + 3) = 95^{\circ}C$$

Reliable operation is insured.

**CAPACITOR REQUIREMENTS**

The output capacitor is needed to insure stability and minimize the output noise. The value of the capacitor varies with the load. However, a minimum value of 10 $\mu$ F aluminum capacitor will guarantee stability over all load conditions. A tantalum capacitor is recommended if a faster load transient response is needed.

If the power source has a high AC impedance, a 0.1 $\mu$ F ceramic capacitor between input & ground is recommended.

**MINIMUM LOAD CURRENT**

To ensure a proper behavior of the regulator under light load, a minimum load of 5mA for SPX3940 is required.

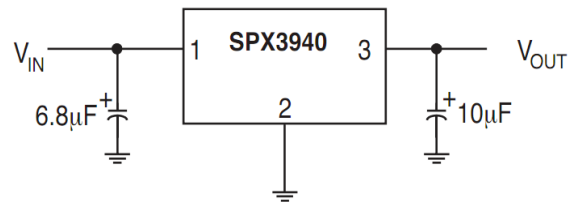
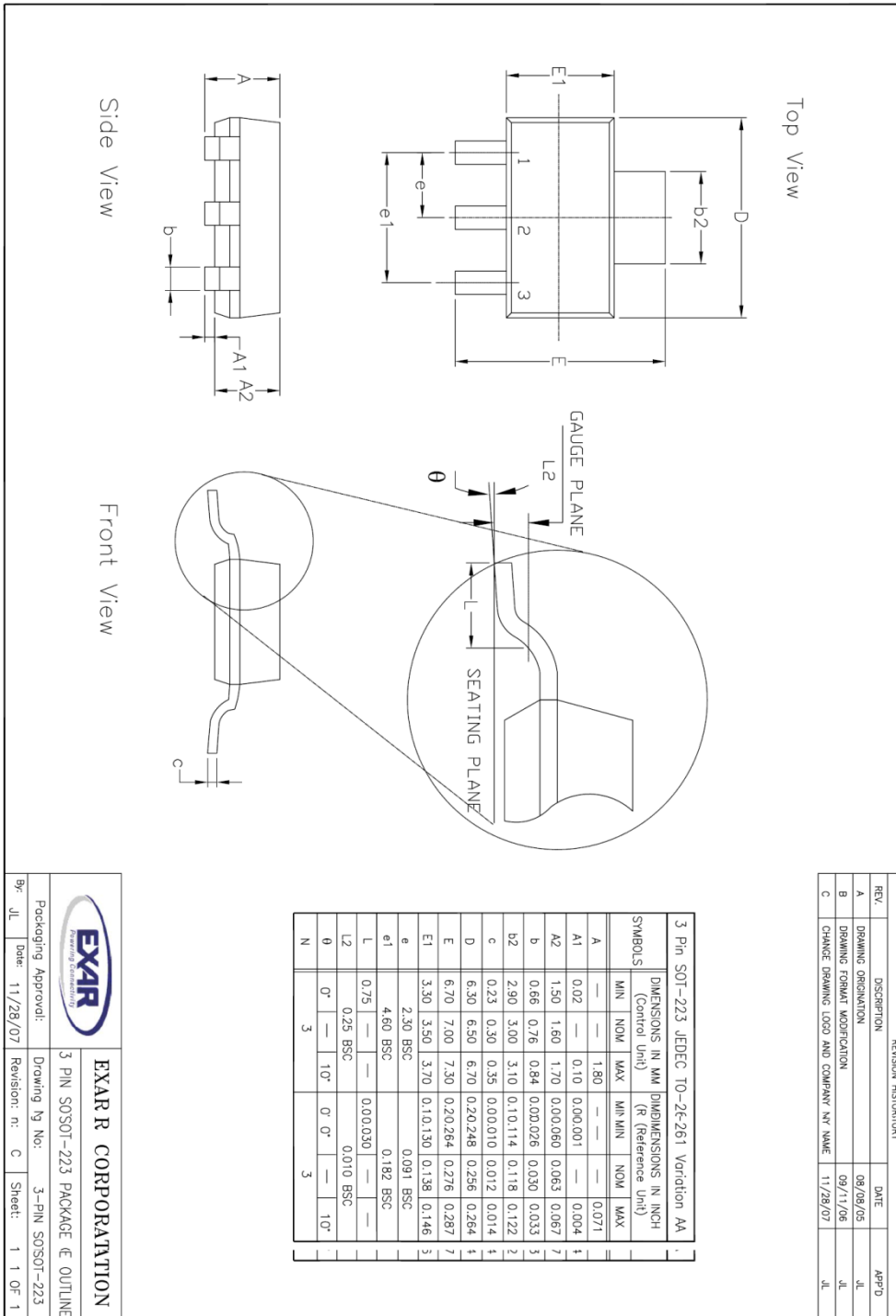

Fig. 20: Fixed Output Linear Regulator



**PACKAGE SPECIFICATION**

**3-PIN SOT-223**



REVISION HISTORY			
REV.	DESCRIPTION	DATE	APP'D
A	DRAWING ORIGINATOR	09/09/05	JL
B	DRAWING FORMAT MODIFICATION	09/11/06	JL
C	CHANGE DRAWING LOGO AND COMPANY NY NAME	11/28/07	JL

	<b>EXAR CORPORATION</b>		
	3 PIN SOT-223 PACKAGE E OUTLINE		
Packaging Approval: By: JL Date: 11/28/07	Drawing by No: Revision: n: C	3-PIN SOT-223 Sheet: 1 of 1	

**3-PIN TO-263**

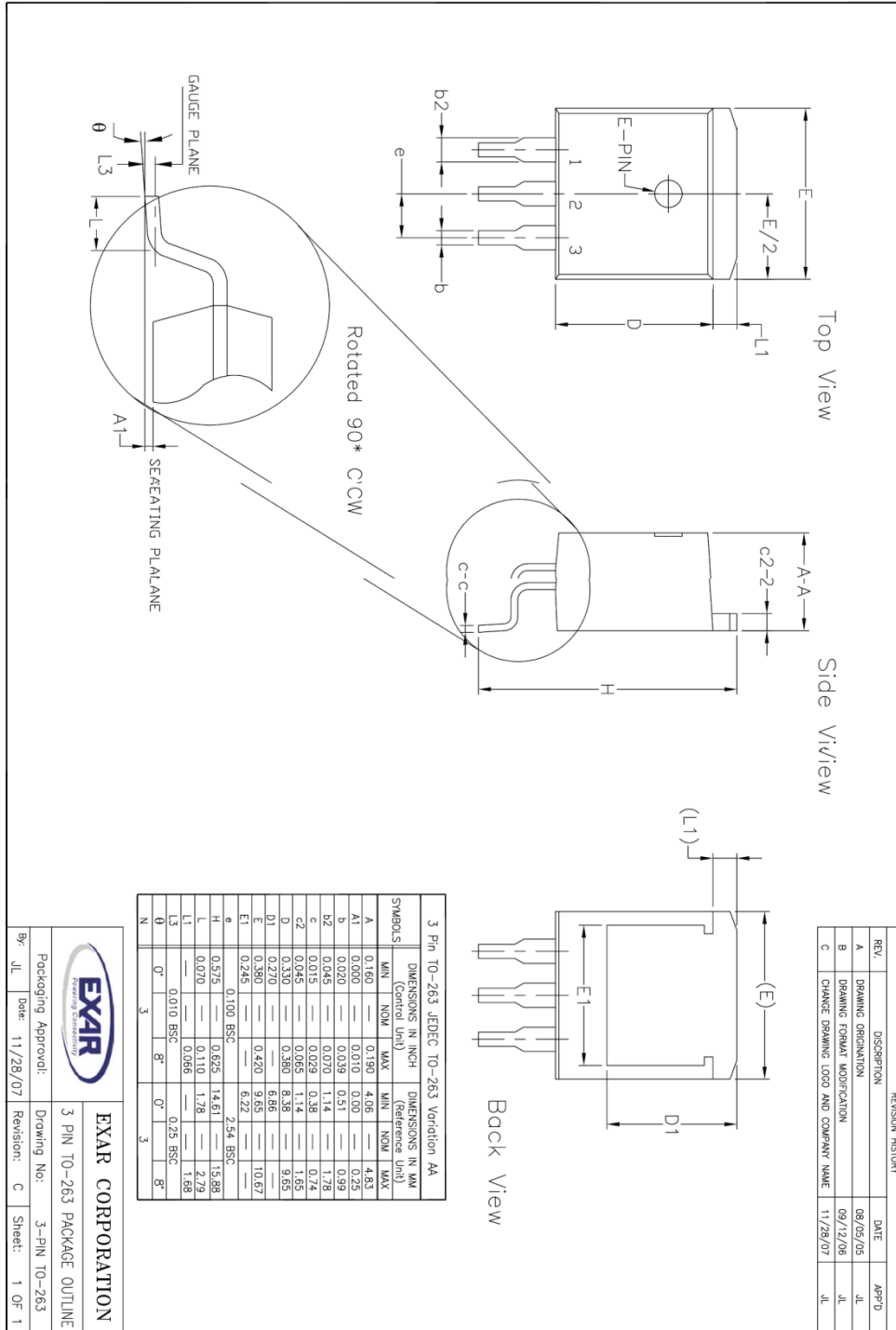



**REVISION HISTORY**

Revision	Date	Description
A	04/14/2006	
1.0.0	02/29/2012	Reformat of Datasheet Package drawing corrections

**FOR FURTHER ASSISTANCE**

Email:

customersupport@exar.com

Exar Technical Documentation:

<http://www.exar.com/TechDoc/default.aspx?>

**EXAR CORPORATION**

**HEADQUARTERS AND SALES OFFICES**

48720 Kato Road

Fremont, CA 94538 – USA

Tel.: +1 (510) 668-7000

Fax: +1 (510) 668-7030

[www.exar.com](http://www.exar.com)



**NOTICE**

EXAR Corporation reserves the right to make changes to the products contained in this publication in order to improve design, performance or reliability. EXAR Corporation assumes no responsibility for the use of any circuits described herein, conveys no license under any patent or other right, and makes no representation that the circuits are free of patent infringement. Charts and schedules contained here in are only for illustration purposes and may vary depending upon a user’s specific application. While the information in this publication has been carefully checked; no responsibility, however, is assumed for inaccuracies.

EXAR Corporation does not recommend the use of any of its products in life support applications where the failure or malfunction of the product can reasonably be expected to cause failure of the life support system or to significantly affect its safety or effectiveness. Products are not authorized for use in such applications unless EXAR Corporation receives, in writing, assurances to its satisfaction that: (a) the risk of injury or damage has been minimized; (b) the user assumes all such risks; (c) potential liability of EXAR Corporation is adequately protected under the circumstances.

Reproduction, in part or whole, without the prior written consent of EXAR Corporation is prohibited.

# Mouser Electronics

Authorized Distributor

Click to View Pricing, Inventory, Delivery & Lifecycle Information:

## Exar:

[SPX3940AT-L-3-3/TR](#) [SPX3940T-L-3-3/TR](#) [SPX3940M3-L-2-5](#) [SPX3940AM3-L-5-0/TR](#) [SPX3940T-L-3-3](#)  
[SPX3940AM3-L-5-0](#) [SPX3940T-L-5-0/TR](#) [SPX3940AM3-L-3-3/TR](#) [SPX3940AM3-L-2-5/TR](#) [SPX3940M3-L-3-3](#)  
[SPX3940M3-L-3-3/TR](#) [SPX3940AM3-L-3-3](#) [SPX3940AT-L-3-3](#) [SPX3940AT-L-5-0/TR](#) [SPX3940AM3-L-1-8](#)  
[SPX3940AM3-L-1-8/TR](#) [SPX3940AT-L-1-8](#) [SPX3940AT-L-5-0](#) [SPX3940M3-L-5-0](#) [SPX3940T-L-5-0](#) [SPX3940M3-L-5-](#)  
[0/TR](#) [SPX3940M3-L-2-5/TR](#) [SPX3940AM3-L-2-5](#) [SPX3940AT-L-1-8/TR](#) [SPX3940AT-L-2-5](#) [SPX3940M3-L-1-8/TR](#)