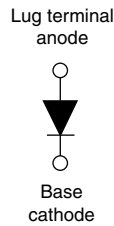

High Performance Schottky Rectifier, 120 A

HALF-PAK (D-67)

FEATURES

- 175 °C T_J operation
- Low forward voltage drop
- High frequency operation
- Guard ring for enhanced ruggedness and long term reliability
- Designed and qualified for industrial level
- UL approved file E222165
- Material categorization: for definitions of compliance please see www.vishay.com/doc?99912

RoHS
COMPLIANT

| PRIMARY CHARACTERISTICS | |
|-------------------------|-----------------|
| $I_{F(AV)}$ | 120 A |
| V_R | 100 V |
| Package | HALF-PAK (D-67) |
| Circuit configuration | Single |

DESCRIPTION

The VS-123NQ.. high current Schottky rectifier module series has been optimized for low reverse leakage at high temperature. The proprietary barrier technology allows for reliable operation up to 175 °C junction temperature. Typical applications are in high current switching power supplies, plating power supplies, UPS systems, converters, freewheeling diodes, welding, and reverse battery protection.

| MAJOR RATINGS AND CHARACTERISTICS | | | |
|-----------------------------------|--|-------------|-------|
| SYMBOL | CHARACTERISTICS | VALUES | UNITS |
| $I_{F(AV)}$ | Rectangular waveform | 120 | A |
| V_{RRM} | | 100 | V |
| I_{FSM} | $t_p = 5 \mu s$ sine | 12 800 | A |
| V_F | 120 A _{pk} , $T_J = 125 \text{ }^\circ\text{C}$ | 0.73 | V |
| T_J | Range | -55 to +175 | °C |

| VOLTAGE RATINGS | | | |
|--------------------------------------|-----------|----------------|-------|
| PARAMETER | SYMBOL | VS-123NQ100PbF | UNITS |
| Maximum DC reverse voltage | V_R | 100 | V |
| Maximum working peak reverse voltage | V_{RWM} | | |

| ABSOLUTE MAXIMUM RATINGS | | | | |
|--|-------------|---|---|--------|
| PARAMETER | SYMBOL | TEST CONDITIONS | VALUES | UNITS |
| Maximum average forward current See fig. 5 | $I_{F(AV)}$ | 50 % duty cycle at $T_C = 133 \text{ }^\circ\text{C}$, rectangular waveform | 120 | A |
| Maximum peak one cycle non-repetitive surge current See fig. 7 | I_{FSM} | 5 μs sine or 3 μs rect. pulse | Following any rated load condition and with rated V_{RRM} applied | 12 800 |
| | | 10 ms sine or 6 ms rect. pulse | | 1800 |
| Non-repetitive avalanche energy | E_{AS} | $T_J = 25 \text{ }^\circ\text{C}$, $I_{AS} = 5.5 \text{ A}$, $L = 1 \text{ mH}$ | 15 | mJ |
| Repetitive avalanche current | I_{AR} | Current decaying linearly to zero in 1 μs Frequency limited by T_J maximum $V_A = 1.5 \times V_R$ typical | 1 | A |



| ELECTRICAL SPECIFICATIONS | | | | | |
|---|----------------|--|-----------------------------------|--------|------------------|
| PARAMETER | SYMBOL | TEST CONDITIONS | | VALUES | UNITS |
| Maximum forward voltage drop See fig. 1 | $V_{FM}^{(1)}$ | 120 A | $T_J = 25\text{ }^\circ\text{C}$ | 0.91 | V |
| | | 240 A | | 1.26 | |
| | | 120 A | $T_J = 125\text{ }^\circ\text{C}$ | 0.73 | |
| | | 240 A | | 0.9 | |
| Maximum reverse leakage current See fig. 2 | I_{RM} | $T_J = 25\text{ }^\circ\text{C}$ | $V_R = \text{Rated } V_R$ | 3 | mA |
| | | $T_J = 125\text{ }^\circ\text{C}$ | | 40 | |
| Maximum junction capacitance | C_T | $V_R = 5 V_{DC}$ (test signal range 100 kHz to 1 MHz) $25\text{ }^\circ\text{C}$ | | 2650 | pF |
| Typical series inductance | L_S | From top of terminal hole to mounting plane | | 7.0 | nH |
| Maximum voltage rate of change | dV/dt | Rated V_R | | 10 000 | V/ μs |

Note

(1) Pulse width = 500 μs

| THERMAL - MECHANICAL SPECIFICATIONS | | | | | |
|--|----------------|--------------------------------------|-------------|---------------------------|--|
| PARAMETER | SYMBOL | TEST CONDITIONS | VALUES | UNITS | |
| Maximum junction and storage temperature range | T_J, T_{Stg} | | -55 to +175 | $^\circ\text{C}$ | |
| Maximum thermal resistance, junction to case | R_{thJC} | DC operation See fig. 4 | 0.38 | $^\circ\text{C}/\text{W}$ | |
| Typical thermal resistance, case to heatsink | R_{thCS} | Mounting surface, smooth and greased | 0.05 | | |
| Approximate weight | | | 30 | g | |
| | | | 1.06 | oz. | |
| Mounting torque | minimum | Non-lubricated threads | 3 (26.5) | N · m (lbf · in) | |
| | maximum | | 4 (35.4) | | |
| Terminal torque | minimum | | 3.4 (30) | | |
| | maximum | | 5 (44.2) | | |
| Case style | | | | HALF-PAK module | |

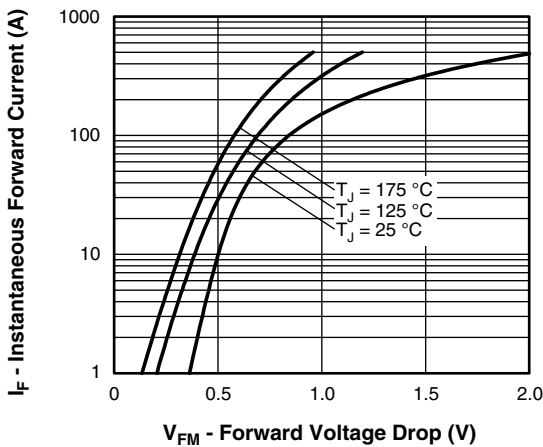

Fig. 1 - Maximum Forward Voltage Drop Characteristics

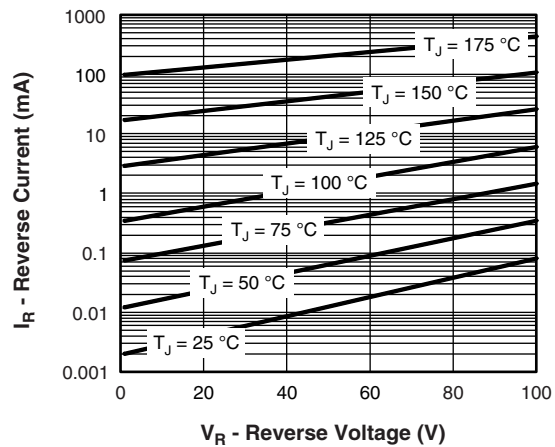

Fig. 2 - Typical Values of Reverse Current vs. Reverse Voltage

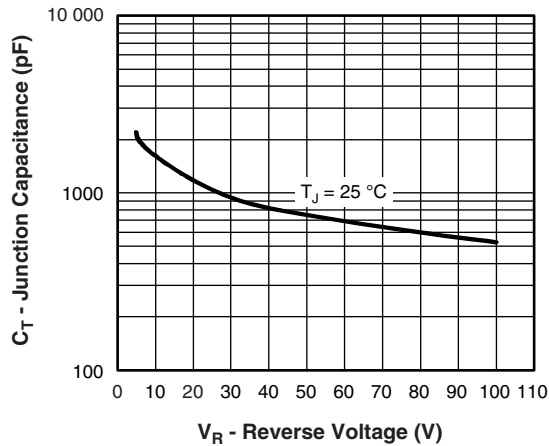

Fig. 3 - Typical Junction Capacitance vs. Reverse Voltage

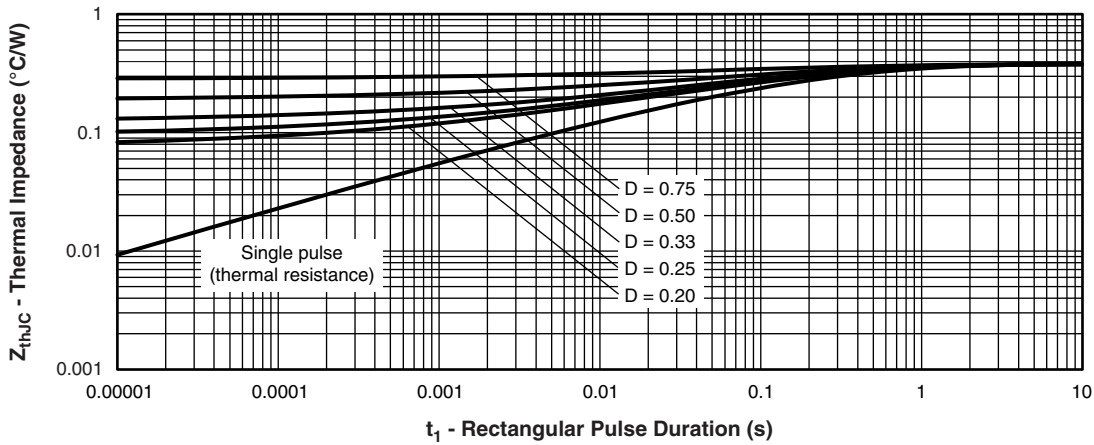

Fig. 4 - Maximum Thermal Impedance Z_{thJC} Characteristics

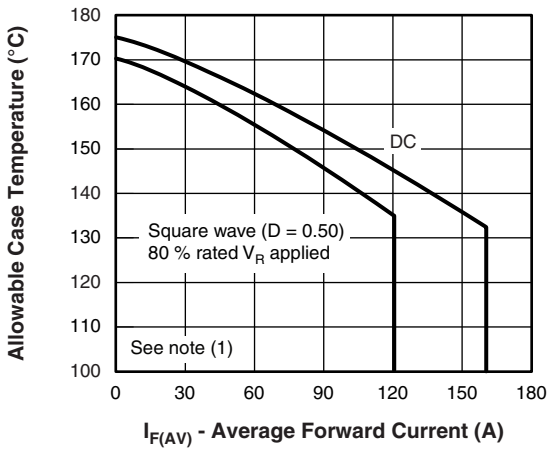

Fig. 5 - Maximum Allowable Case Temperature vs. Average Forward Current

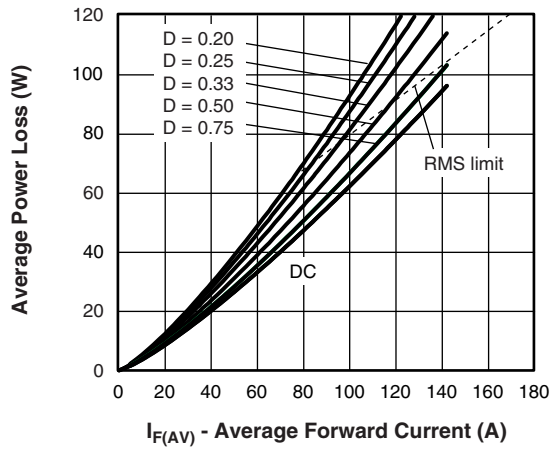

Fig. 6 - Forward Power Loss Characteristics

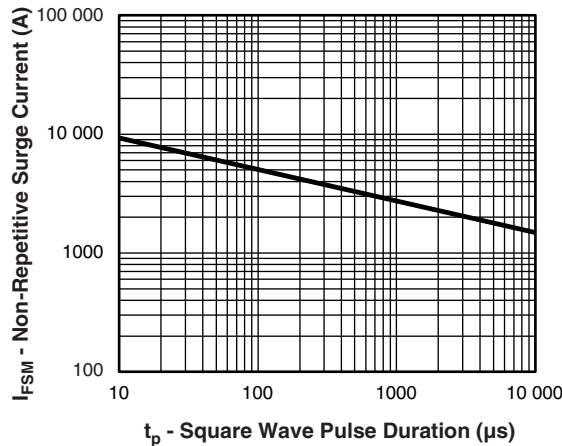

Fig. 7 - Maximum Non-Repetitive Surge Current

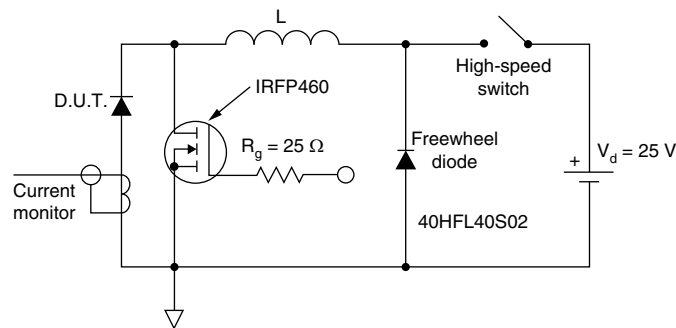

Fig. 8 - Unclamped Inductive Test Circuit

Note

- (1) Formula used: $T_C = T_J - (P_d + P_{d_{REV}}) \times R_{thJC}$;
- P_d = forward power loss = $I_{F(AV)} \times V_{FM}$ at $(I_{F(AV)}/D)$ (see fig. 6);
- $P_{d_{REV}}$ = inverse power loss = $V_{R1} \times I_R (1 - D)$; I_R at V_{R1} = rated V_R

ORDERING INFORMATION TABLE

| | | | | | | | |
|-------------|------------|-----------|--------------------------------|----------|----------|------------|------------|
| Device code | VS- | 12 | 3 | N | Q | 100 | PbF |
| | ① | ② | ③ | ④ | ⑤ | ⑥ | ⑦ |
| | 1 | - | Vishay Semiconductors product | | | | |
| | 2 | - | Average current rating (x 10) | | | | |
| | 3 | - | Product silicon identification | | | | |
| | 4 | - | N = not isolated | | | | |
| | 5 | - | Q = Schottky rectifier diode | | | | |
| | 6 | - | Voltage rating (100 = 100 V) | | | | |
| | 7 | - | Lead (Pb)-free | | | | |

| LINKS TO RELATED DOCUMENTS | |
|----------------------------|--|
| Dimensions | www.vishay.com/doc?95020 |

D-67 HALF-PAK

DIMENSIONS in millimeters (inches)

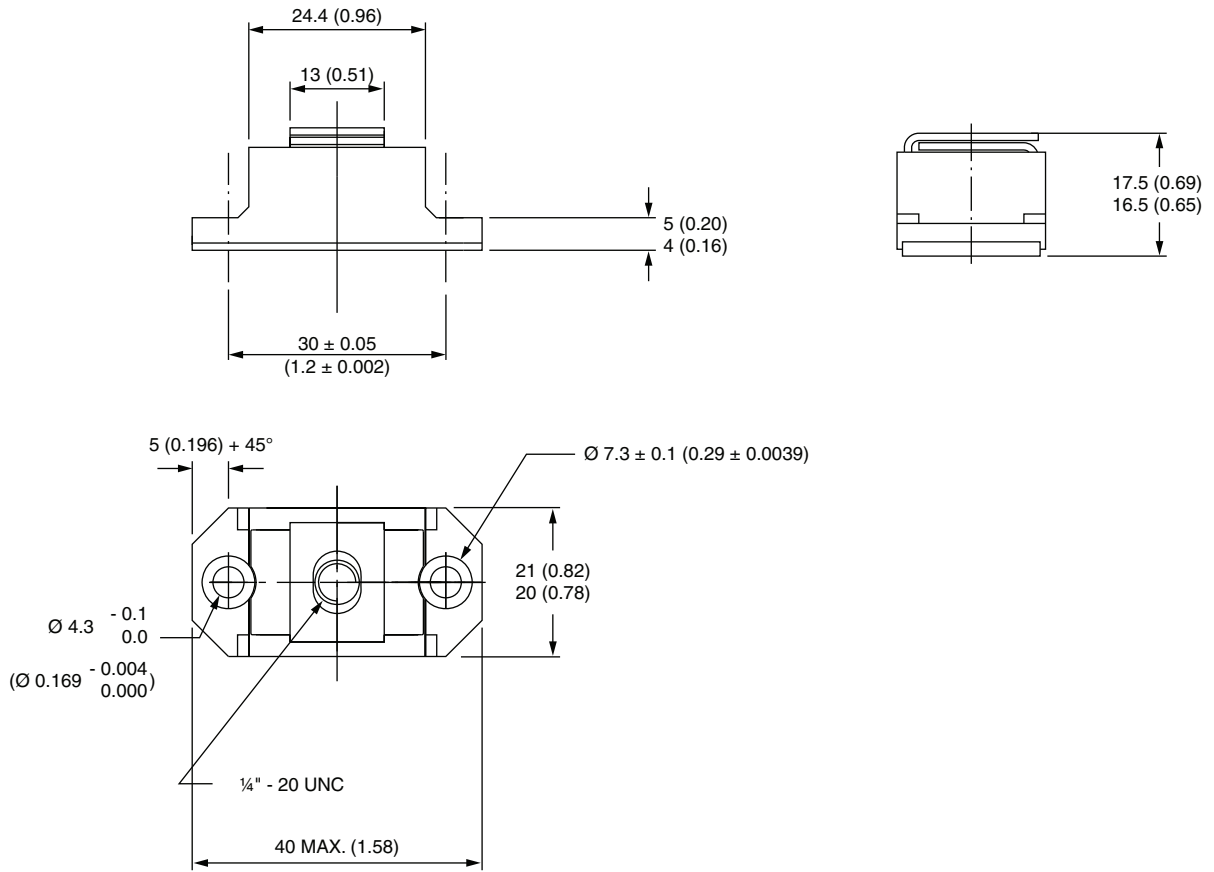



Disclaimer

ALL PRODUCT, PRODUCT SPECIFICATIONS AND DATA ARE SUBJECT TO CHANGE WITHOUT NOTICE TO IMPROVE RELIABILITY, FUNCTION OR DESIGN OR OTHERWISE.

Vishay Intertechnology, Inc., its affiliates, agents, and employees, and all persons acting on its or their behalf (collectively, "Vishay"), disclaim any and all liability for any errors, inaccuracies or incompleteness contained in any datasheet or in any other disclosure relating to any product.

Vishay makes no warranty, representation or guarantee regarding the suitability of the products for any particular purpose or the continuing production of any product. To the maximum extent permitted by applicable law, Vishay disclaims (i) any and all liability arising out of the application or use of any product, (ii) any and all liability, including without limitation special, consequential or incidental damages, and (iii) any and all implied warranties, including warranties of fitness for particular purpose, non-infringement and merchantability.

Statements regarding the suitability of products for certain types of applications are based on Vishay's knowledge of typical requirements that are often placed on Vishay products in generic applications. Such statements are not binding statements about the suitability of products for a particular application. It is the customer's responsibility to validate that a particular product with the properties described in the product specification is suitable for use in a particular application. Parameters provided in datasheets and / or specifications may vary in different applications and performance may vary over time. All operating parameters, including typical parameters, must be validated for each customer application by the customer's technical experts. Product specifications do not expand or otherwise modify Vishay's terms and conditions of purchase, including but not limited to the warranty expressed therein.

Except as expressly indicated in writing, Vishay products are not designed for use in medical, life-saving, or life-sustaining applications or for any other application in which the failure of the Vishay product could result in personal injury or death. Customers using or selling Vishay products not expressly indicated for use in such applications do so at their own risk. Please contact authorized Vishay personnel to obtain written terms and conditions regarding products designed for such applications.

No license, express or implied, by estoppel or otherwise, to any intellectual property rights is granted by this document or by any conduct of Vishay. Product names and markings noted herein may be trademarks of their respective owners.

Mouser Electronics

Authorized Distributor

Click to View Pricing, Inventory, Delivery & Lifecycle Information:

Vishay:

[123NQ100R](#) [VS-123NQ100PBF](#)