

High Voltage IGBT w/ Sonic Diode

IXGT16N170A
IXGH16N170A
IXGT16N170AH1
IXGH16N170AH1

$V_{CES} = 1700V$
 $I_{C90} = 11A$
 $V_{CE(sat)} \leq 5.0V$
 $t_{fi(typ)} = 35ns$

| Symbol | Test Conditions | Maximum Ratings | |
|----------------|--|---------------------|------------|
| | | | |
| V_{CES} | $T_J = 25^\circ C$ to $150^\circ C$ | 1700 | V |
| V_{CGR} | $T_J = 25^\circ C$ to $150^\circ C$, $R_{GE} = 1M\Omega$ | 1700 | V |
| V_{GES} | Continuous | ± 20 | V |
| V_{GEM} | Transient | ± 30 | V |
| I_{C25} | $T_C = 25^\circ C$ | 16 | A |
| I_{C90} | $T_C = 90^\circ C$ | 11 | A |
| I_{F90} | $T_C = 90^\circ C$ | 17 | A |
| I_{CM} | $T_C = 25^\circ C$, 1ms | 40 | A |
| SSOA | $V_{GE} = 15V$, $T_{VJ} = 125^\circ C$, $R_G = 10\Omega$ | $I_{CM} = 40$ | A |
| (RBSOA) | Clamped Inductive Load | $0.8 \cdot V_{CES}$ | |
| t_{sc} | $V_{GE} = 15V$, $V_{CE} = 1200V$, $T_J = 125^\circ C$ | 10 | μs |
| (SCSOA) | $R_G = 22\Omega$, Non Repetitive | | |
| P_C | $T_C = 25^\circ C$ | 190 | W |
| T_J | | -55 ... +150 | $^\circ C$ |
| T_{JM} | | 150 | $^\circ C$ |
| T_{stg} | | -55 ... +150 | $^\circ C$ |
| T_L | Maximum Lead Temperature for Soldering | 300 | $^\circ C$ |
| T_{SOLD} | Plastic Body for 10s | 260 | $^\circ C$ |
| M_d | Mounting Torque (TO-247) | 1.13/10 | Nm/lb.in |
| Weight | TO-268 | 4 | g |
| | TO-247 | 6 | g |

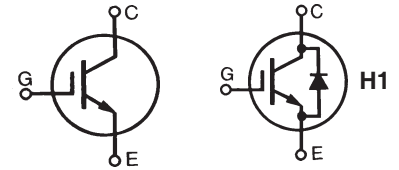

TO-268 (IXGT)

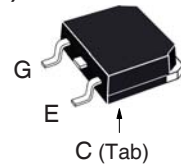

TO-247 (IXGH)

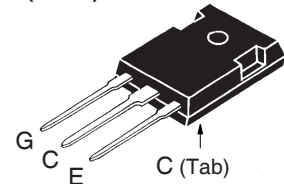

G = Gate C = Collector
 E = Emitter Tab = Collector

Features

- High Blocking Voltage
- International Standard Packages
- Low Conduction Losses
- Anti-Parallel Sonic Diode
- High Blocking Voltage
- High Current Handling Capability

Advantages

- Low Gate Drive Requirement
- High Power Density

Applications

- Switch-Mode and Resonant-Mode Power Supplies
- Uninterruptible Power Supplies (UPS)
- AC Choppers
- Capacitor Discharge Circuits
- AC Motor Drives
- DC Servo & Robot Drives

| Symbol | Test Conditions | Characteristic Values | | |
|---------------|---|-----------------------|------|--------------|
| | | Min. | Typ. | Max. |
| BV_{CES} | $I_C = 250\mu A$, $V_{GE} = 0V$ | 1700 | | V |
| $V_{GE(th)}$ | $I_C = 250\mu A$, $V_{CE} = V_{GE}$ | 3.0 | | 5.0 V |
| I_{CES} | $V_{CE} = 0.8 \cdot V_{CES}$, $V_{GE} = 0V$ $T_J = 125^\circ C$ | 16N170A | | 50 μA |
| | | 16N170AH1 | | 100 μA |
| | | 16N170A | | 750 μA |
| | | 16N170AH1 | | 1.5 mA |
| I_{GES} | $V_{CE} = 0V$, $V_{GE} = \pm 20V$ | | | ± 100 nA |
| $V_{CE(sat)}$ | $I_C = 11A$, $V_{GE} = 15V$, Note 1 $T_J = 125^\circ C$ | | 4.0 | 5.0 V |
| | | | 4.5 | V |

| Symbol | Test Conditions | Characteristic Values | | |
|--|--|-----------------------|------|-------------------|
| | | Min. | Typ. | Max. |
| g_{fs} | $I_C = 16A, V_{CE} = 10V, \text{Note 1}$ | 6.0 | 12.5 | S |
| C_{ies} C_{oes} C_{res} | $V_{CE} = 25V, V_{GE} = 0V, f = 1MHz$ | 16N170A 16N170AH1 | 1500 | pF |
| | | | 99 | pF |
| | | | 110 | pF |
| | | | 33 | pF |
| $Q_{g(on)}$ Q_{ge} Q_{gc} | $I_C = 11A, V_{GE} = 15V, V_{CE} = 0.5 \cdot V_{CES}$ | | 70 | nC |
| | | | 9 | nC |
| | | | 32 | nC |
| $t_{d(on)}$ t_{ri} E_{on} $t_{d(off)}$ t_{fi} E_{off} | Inductive load, $T_J = 25^\circ C$ $I_C = 16A, V_{GE} = 15V$ $V_{CE} = 0.5 \cdot V_{CES}, R_G = 10\Omega$ Note 2 | | 12 | ns |
| | | | 22 | ns |
| | | | 2.35 | mJ |
| | | | 200 | 300 ns |
| | | | 35 | 150 ns |
| | | | 0.38 | 1.50 mJ |
| $t_{d(on)}$ t_{ri} E_{on} $t_{d(off)}$ t_{fi} E_{off} | Inductive load, $T_J = 125^\circ C$ $I_C = 16A, V_{GE} = 15V$ $V_{CE} = 0.5 \cdot V_{CES}, R_G = 10\Omega$ Note 2 | | 13 | ns |
| | | | 22 | ns |
| | | | 2.80 | mJ |
| | | | 210 | ns |
| | | | 88 | ns |
| | | | 0.67 | mJ |
| R_{thJC} R_{thCS} | | | 0.21 | 0.65 °C/W °C/W |

Reverse Sonic Diode (FRD)

| Symbol | Test Conditions | Characteristic Values | | |
|----------------------|--|-----------------------|------|----------|
| | | Min. | Typ. | Max. |
| V_F | $I_F = 20A, V_{GE} = 0V, \text{Note 1}$ | $T_J = 125^\circ C$ | 2.8 | 3.4 V |
| t_{rr} I_{RM} | $I_F = 10A, V_{GE} = 0V,$ $-di_F/dt = 250A/\mu s, V_R = 900V$ | $T_J = 125^\circ C$ | 300 | ns |
| | | | 550 | ns |
| | | $T_J = 125^\circ C$ | 13 | A |
| | | | 15 | A |
| R_{thJC} | | | | 1.5 °C/W |

Notes:

1. Pulse test, $t \leq 300\mu s$, duty cycle, $d \leq 2\%$.
2. Switching times & energy losses may increase for higher V_{CE} (clamp), T_J or R_G .

TO-268 Outline

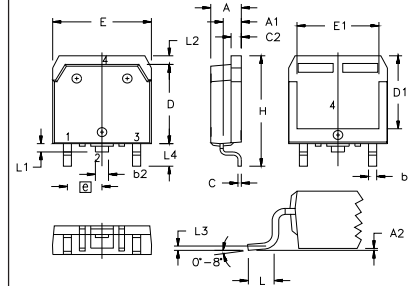

Terminals: 1 - Gate 2,4 - Collector
3 - Emitter

| SYM | INCHES | | MILLIMETERS | |
|-----|----------|------|-------------|-------|
| | MIN | MAX | MIN | MAX |
| A | .193 | .201 | 4.90 | 5.10 |
| A1 | .106 | .114 | 2.70 | 2.90 |
| A2 | .001 | .010 | 0.02 | 0.25 |
| b | .045 | .057 | 1.15 | 1.45 |
| b2 | .075 | .083 | 1.90 | 2.10 |
| C | .016 | .026 | 0.40 | 0.65 |
| C2 | .057 | .063 | 1.45 | 1.60 |
| D | .543 | .551 | 13.80 | 14.00 |
| D1 | .488 | .500 | 12.40 | 12.70 |
| E | .624 | .632 | 15.85 | 16.05 |
| E1 | .524 | .535 | 13.30 | 13.60 |
| e | .215 BSC | | 5.45 BSC | |
| H | .736 | .752 | 18.70 | 19.10 |
| L | .094 | .106 | 2.40 | 2.70 |
| L1 | .047 | .055 | 1.20 | 1.40 |
| L2 | .039 | .045 | 1.00 | 1.15 |
| L3 | .010 BSC | | 0.25 BSC | |
| L4 | .150 | .161 | 3.80 | 4.10 |

TO-247 Outline

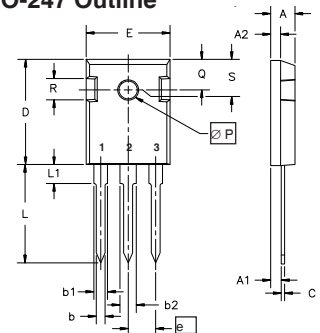

Terminals: 1 - Gate 2 - Collector
3 - Emitter

| Dim. | Millimeter | | Inches | |
|----------------|------------|-------|--------|-------|
| | Min. | Max. | Min. | Max. |
| A | 4.7 | 5.3 | .185 | .209 |
| A ₁ | 2.2 | 2.54 | .087 | .102 |
| A ₂ | 2.2 | 2.6 | .059 | .098 |
| b | 1.0 | 1.4 | .040 | .055 |
| b ₁ | 1.65 | 2.13 | .065 | .084 |
| b ₂ | 2.87 | 3.12 | .113 | .123 |
| C | .4 | .8 | .016 | .031 |
| D | 20.80 | 21.46 | .819 | .845 |
| E | 15.75 | 16.26 | .610 | .640 |
| e | 5.20 | 5.72 | 0.205 | 0.225 |
| L | 19.81 | 20.32 | .780 | .800 |
| L1 | | 4.50 | | .177 |
| ∅P | 3.55 | 3.65 | .140 | .144 |
| Q | 5.89 | 6.40 | 0.232 | 0.252 |
| R | 4.32 | 5.49 | .170 | .216 |
| S | 6.15 | BSC | 242 | BSC |

IXYS Reserves the Right to Change Limits, Test Conditions, and Dimensions.

| | | | | | | | | | | |
|--|-----------|-----------|-----------|-----------|--------------|--------------|--------------|--------------|--------------|-------------|
| IXYS MOSFETs and IGBTs are covered by one or more of the following U.S. patents: | 4,835,592 | 4,931,844 | 5,049,961 | 5,237,481 | 6,162,665 | 6,404,065 B1 | 6,683,344 | 6,727,585 | 7,005,734 B2 | 7,157,338B2 |
| | 4,860,072 | 5,017,508 | 5,063,307 | 5,381,025 | 6,259,123 B1 | 6,534,343 | 6,710,405 B2 | 6,759,692 | 7,063,975 B2 | |
| | 4,881,106 | 5,034,796 | 5,187,117 | 5,486,715 | 6,306,728 B1 | 6,583,505 | 6,710,463 | 6,771,478 B2 | 7,071,537 | |

Fig. 1. Output Characteristics @ $T_J = 25^\circ\text{C}$

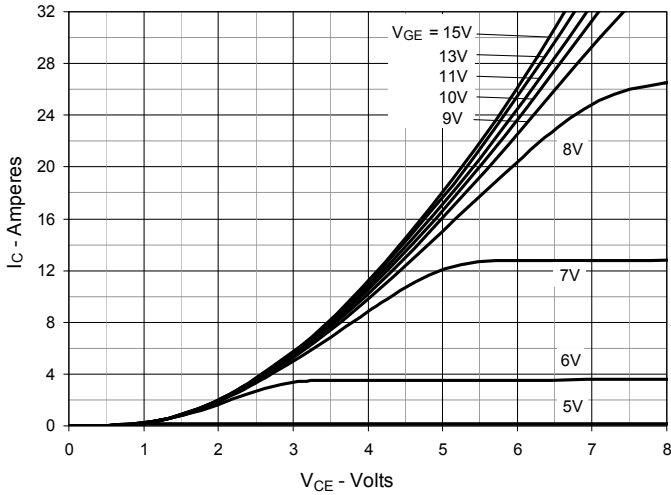

Fig. 2. Extended Output Characteristics @ $T_J = 25^\circ\text{C}$

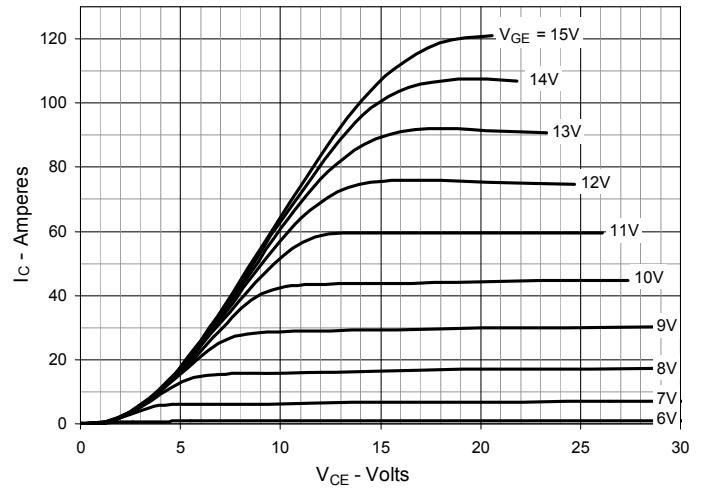

Fig. 3. Output Characteristics @ $T_J = 125^\circ\text{C}$

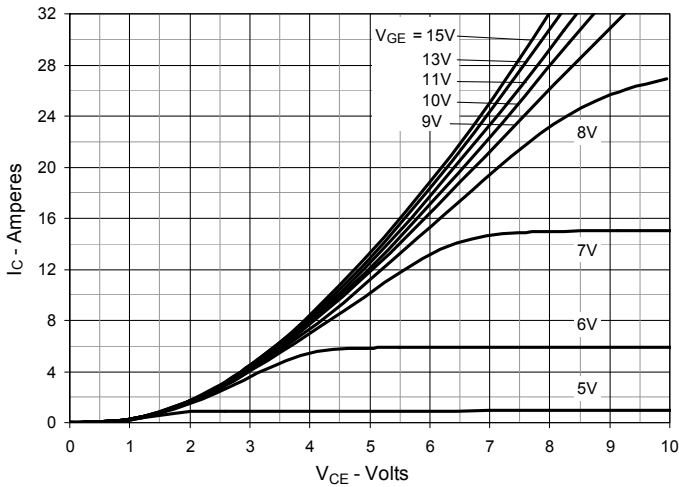

Fig. 4. Dependence of $V_{CE(sat)}$ on Junction Temperature

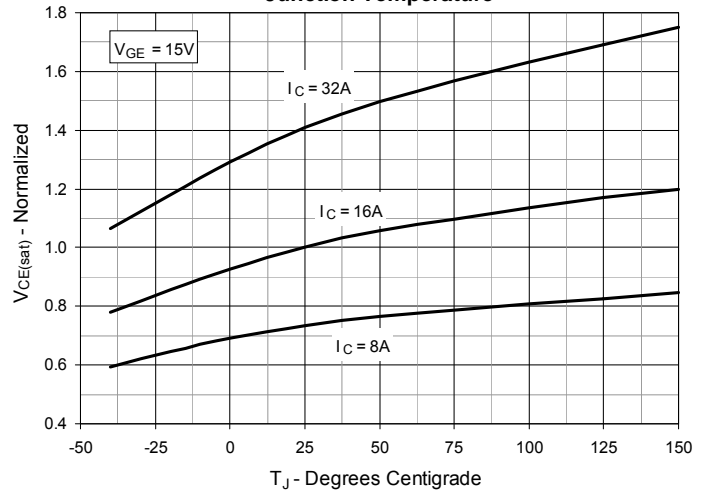

Fig. 5. Collector-to-Emitter Voltage vs. Gate-to-Emitter Voltage

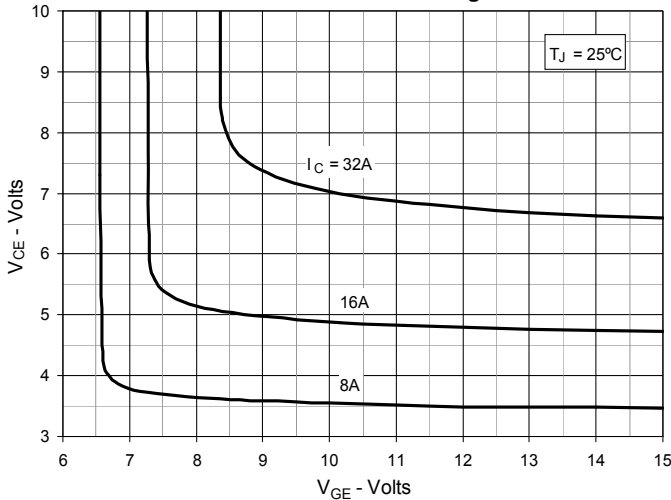

Fig. 6. Input Admittance

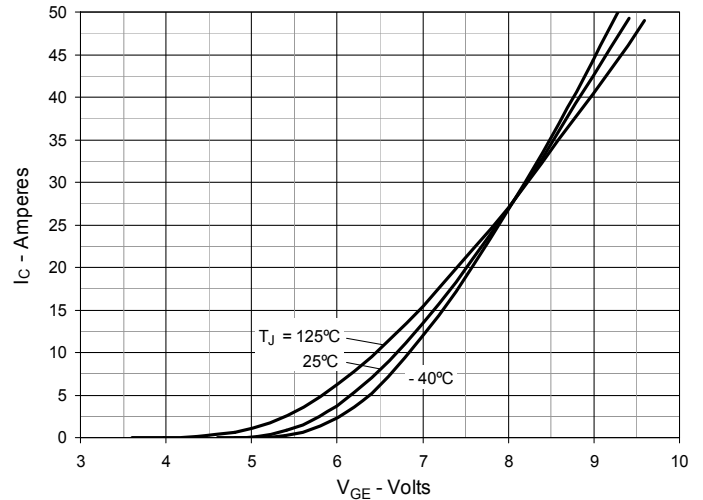

Fig. 7. Transconductance

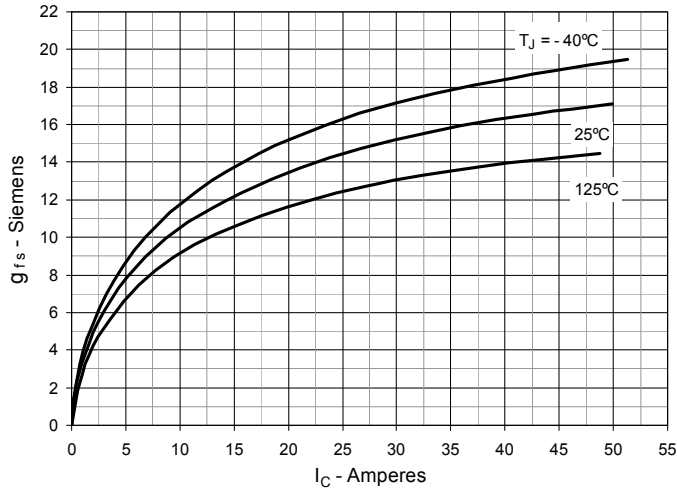

Fig. 8. Gate Charge

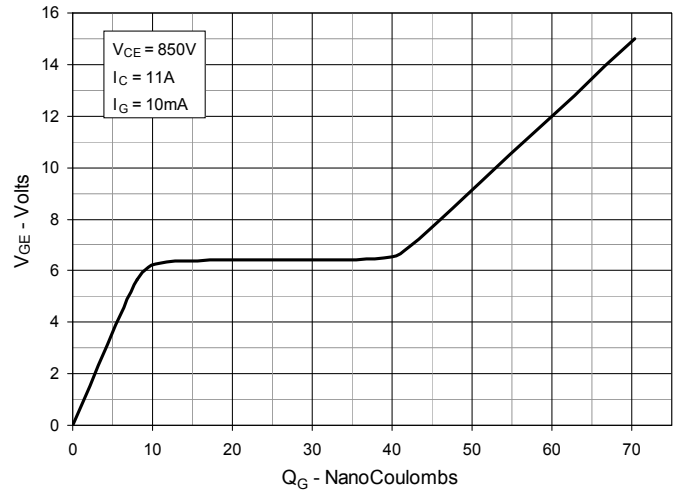

Fig. 9. Capacitance

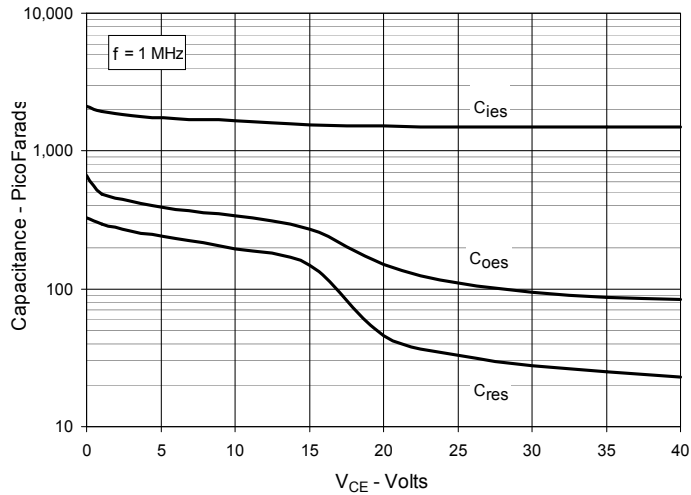

Fig. 10. Reverse-Bias Safe Operating Area

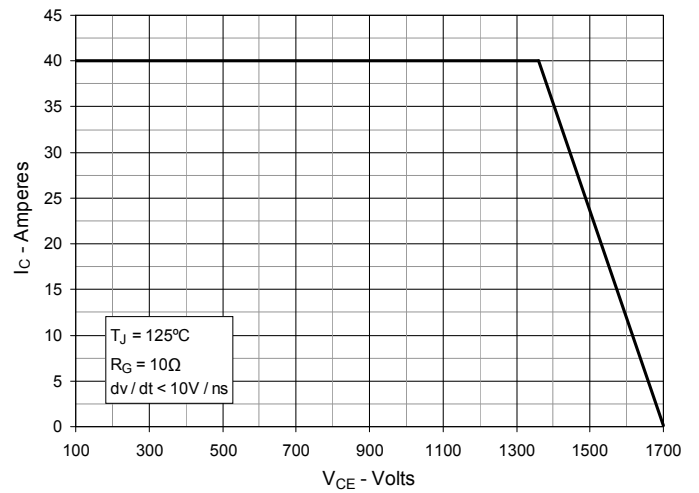

Fig. 11. Maximum Transient Thermal Impedance (IGBT)

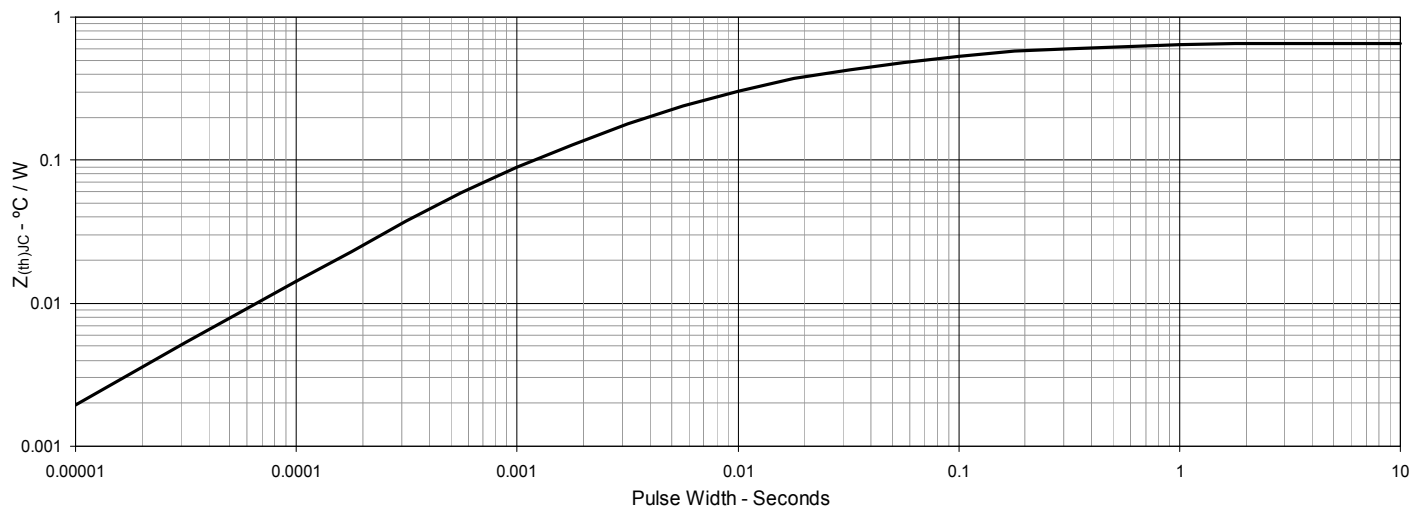

Fig. 12. Inductive Switching Energy Loss vs. Gate Resistance



Fig. 13. Inductive Switching Energy Loss vs. Collector Current

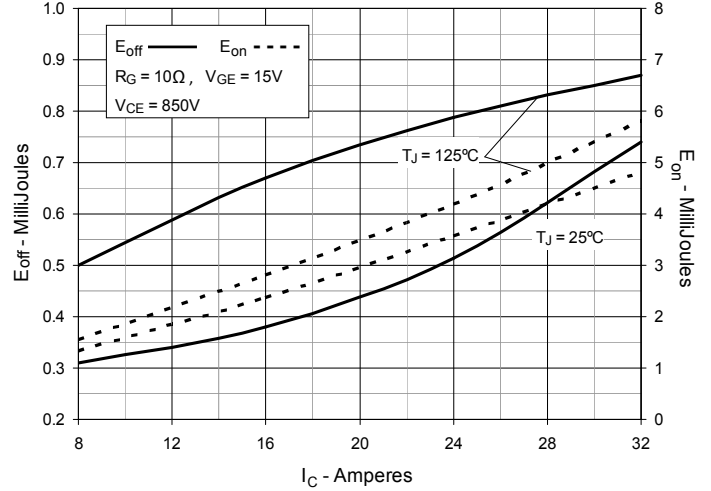

Fig. 14. Inductive Switching Energy Loss vs. Junction Temperature

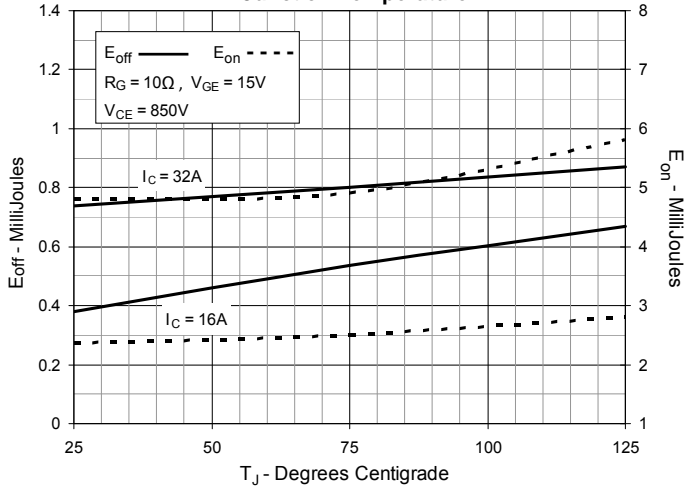

Fig. 15. Inductive Turn-off Switching Times vs. Gate Resistance

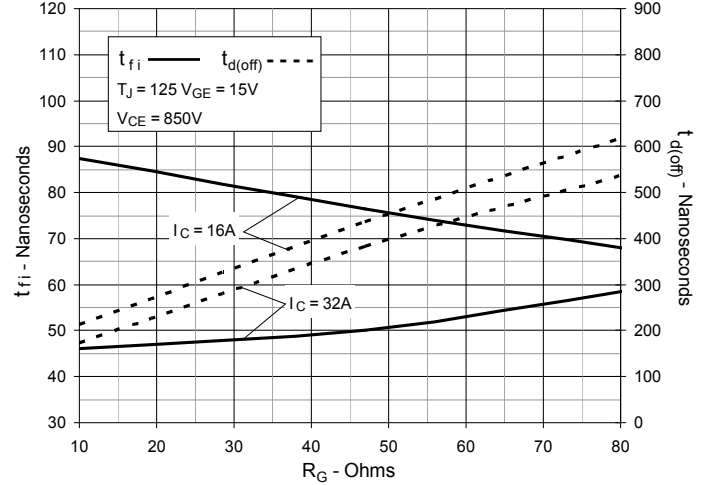

Fig. 16. Inductive Turn-off Switching Times vs. Collector Current

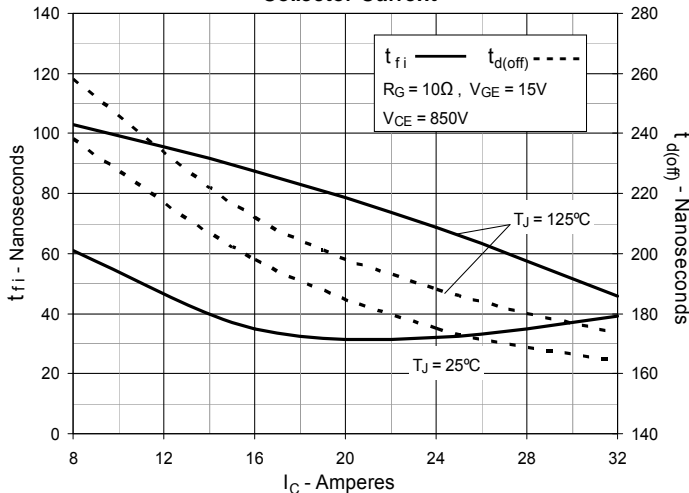

Fig. 17. Inductive Turn-off Switching Times vs. Junction Temperature

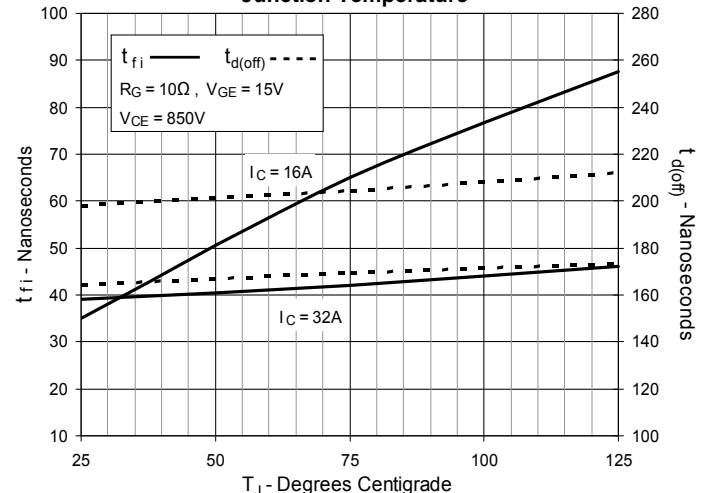

Fig. 18. Inductive Turn-on Switching Times vs. Gate Resistance

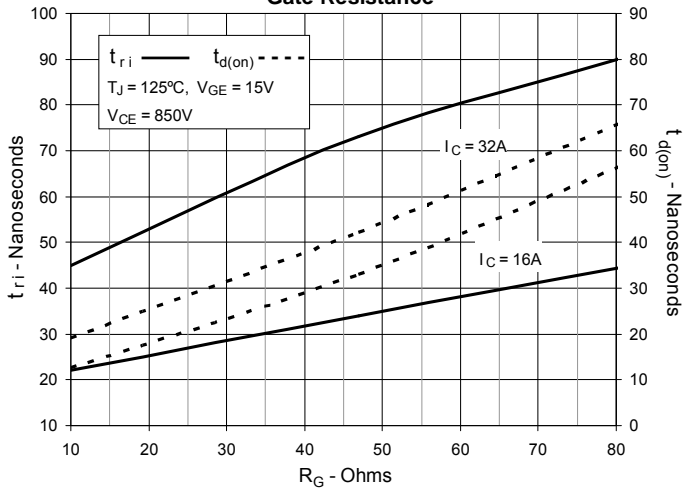

Fig. 19. Inductive Turn-on Switching Times vs. Collector Current

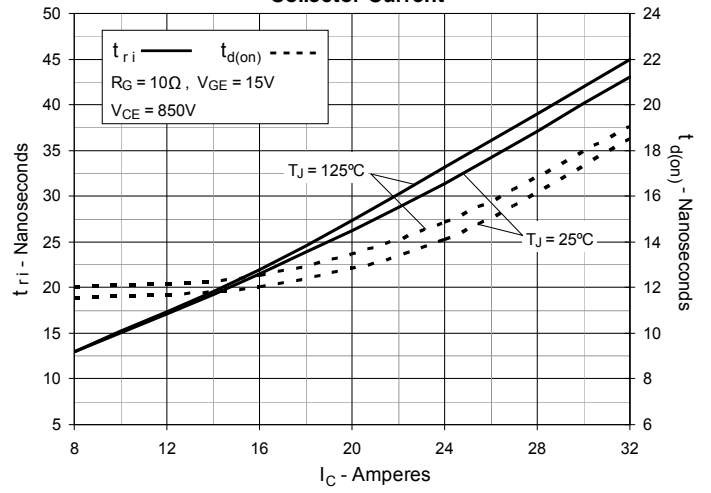

Fig. 20. Inductive Turn-on Switching Times vs. Junction Temperature

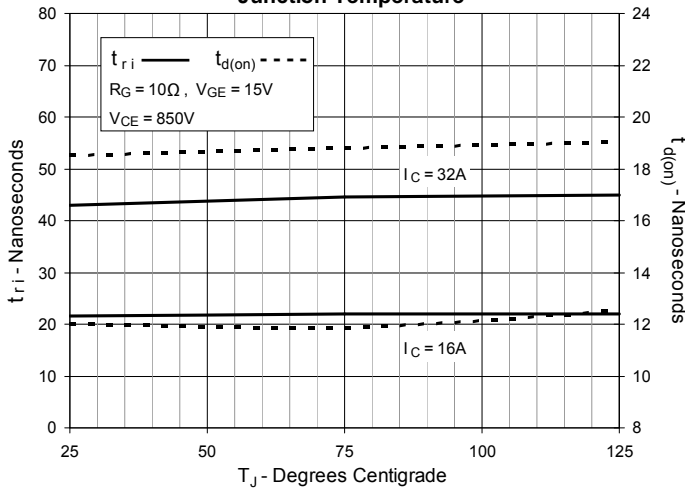

Fig. 21. Forward Current I_F vs V_F



Fig. 22. Reverse Recovery Charge Q_{rr} vs. $-di_F/dt$

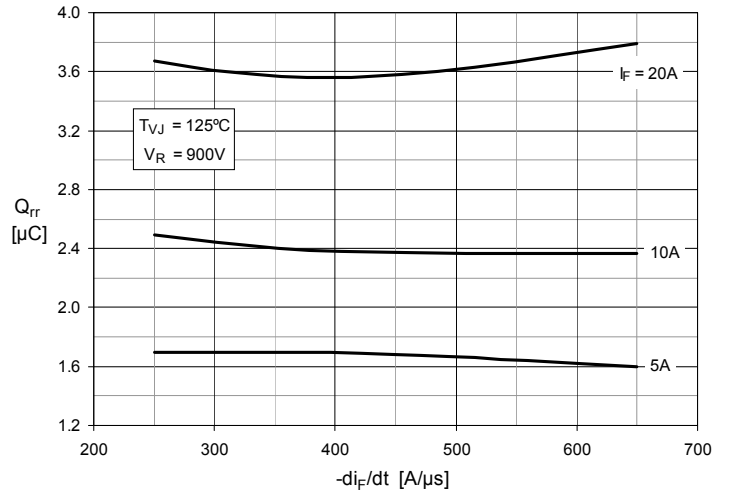

Fig. 23. Peak Reverse Current I_{RM} vs. $-di_F/dt$

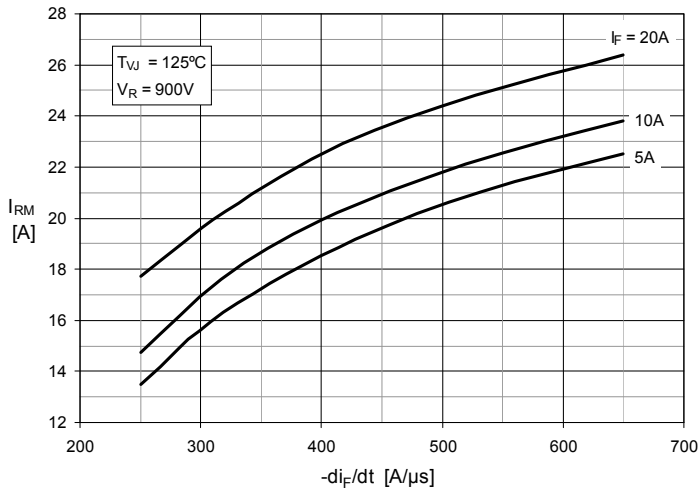

Fig. 24. Recovery Time t_{rr} vs. $-di_F/dt$

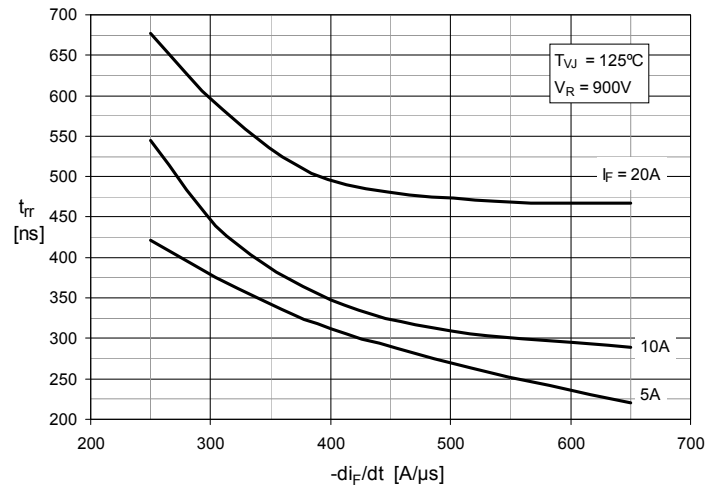

Fig. 25. Recovery Energy E_{rec} vs $-di_F/dt$

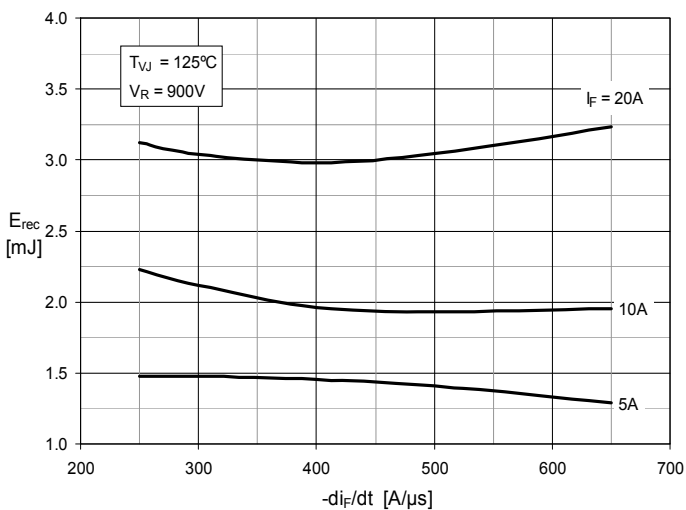
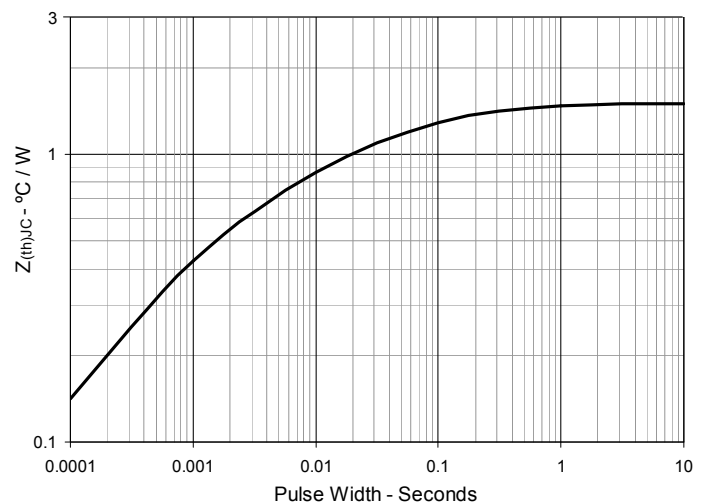

Fig. 26. Maximum Transient Thermal Impedance (Diode)



Mouser Electronics

Authorized Distributor

Click to View Pricing, Inventory, Delivery & Lifecycle Information:

[IXYS:](#)

[IXGT16N170AH1](#) [IXGH16N170AH1](#) [IXGH16N170A](#) [IXGT16N170A](#)