

LMT85-Q1 1.8-V, SC70, Analog Temperature Sensors

1 Features

- LMT85-Q1 is AEC-Q100 Qualified for Automotive Applications:
 - Device Temperature Grade 0: -40°C to $+150^{\circ}\text{C}$
 - Device HBM ESD Classification Level 2
 - Device CDM ESD Classification Level C6
- Very Accurate: $\pm 0.4^{\circ}\text{C}$ Typical
- Low 1.8-V Operation
- Average Sensor Gain of $-8.2\text{ mV}/^{\circ}\text{C}$
- Low $5.4\text{-}\mu\text{A}$ Quiescent Current
- Wide Temperature Range: -50°C to 150°C
- Output is Short-Circuit Protected
- Push-Pull Output With $\pm 50\text{-}\mu\text{A}$ Drive Capability
- Footprint Compatible With the Industry-Standard LM20/19 and LM35 Temperature Sensors
- Cost-Effective Alternative to Thermistors

2 Applications

- Infotainment and Cluster
- Powertrain Systems
- Smoke and Heat Detectors
- Drones
- Appliances

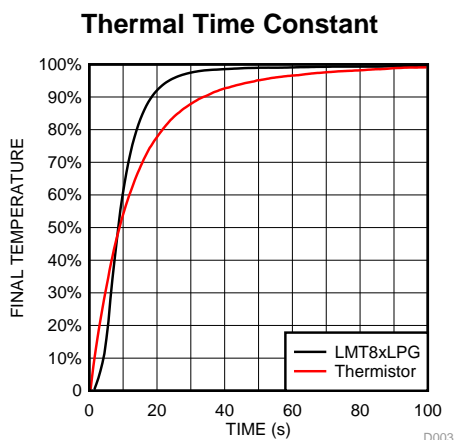

* Fast thermal response NTC

3 Description

The LMT85-Q1 is a precision CMOS temperature sensor with $\pm 0.4^{\circ}\text{C}$ typical accuracy ($\pm 2.7^{\circ}\text{C}$ maximum) and a linear analog output voltage that is inversely proportional to temperature. The 1.8-V supply voltage operation, $5.4\text{-}\mu\text{A}$ quiescent current, and 0.7-ms power-on time enable effective power-cycling architectures to minimize power consumption for battery-powered applications such as drones and sensor nodes. The LMT85-Q1 device is AEC-Q100 Grade 0 qualified and maintains $\pm 2.7^{\circ}\text{C}$ maximum accuracy over the full operating temperature range without calibration; this makes the LMT85-Q1 suitable for automotive applications such as infotainment, cluster, and powertrain systems. The accuracy over the wide operating range and other features make the LMT85-Q1 an excellent alternative to thermistors.

For devices with different average sensor gains and comparable accuracy, refer to [Comparable Alternative Devices](#) for alternative devices in the LMT8x family.

Device Information⁽¹⁾

PART NUMBER	PACKAGE	BODY SIZE (NOM)
LMT85-Q1	SOT (5)	2.00 mm x 1.25 mm

(1) For all available packages, see the orderable addendum addendum at the end of the data sheet.

Output Voltage vs Temperature

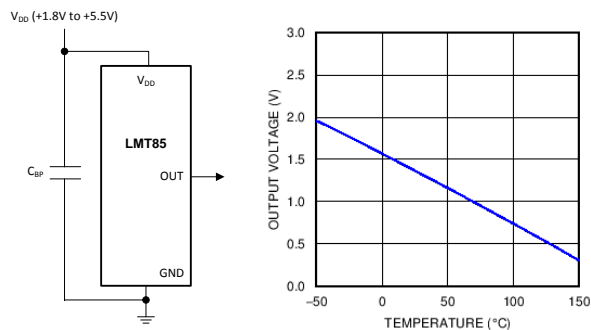

Copyright © 2016, Texas Instruments Incorporated



Table of Contents

1 Features 1 2 Applications 1 3 Description 1 4 Revision History 2 5 Device Comparison Tables 3 6 Pin Configuration and Functions 3 7 Specifications 4 7.1 Absolute Maximum Ratings 4 7.2 ESD Ratings..... 4 7.3 Recommended Operating Conditions 4 7.4 Thermal Information 4 7.5 Accuracy Characteristics..... 5 7.6 Electrical Characteristics 5 7.7 Typical Characteristics 6 8 Detailed Description 8 8.1 Overview 8 8.2 Functional Block Diagram 8	8.3 Feature Description..... 8 8.4 Device Functional Modes..... 10 9 Application and Implementation 12 9.1 Application Information..... 12 9.2 Typical Applications 12 10 Power Supply Recommendations 13 11 Layout 14 11.1 Layout Guidelines 14 11.2 Layout Example 14 12 Device and Documentation Support 15 12.1 Receiving Notification of Documentation Updates 15 12.2 Community Resources..... 15 12.3 Trademarks 15 12.4 Electrostatic Discharge Caution..... 15 12.5 Glossary 15 13 Mechanical, Packaging, and Orderable Information 15
---	---

4 Revision History

NOTE: Page numbers for previous revisions may differ from page numbers in the current version.

DATE	REVISION	NOTES
October 2017	*	Initial release. Moved the automotive device from the SNIS200 to a standalone data sheet.

5 Device Comparison Tables

Table 1. Available Device Packages

ORDER NUMBER ⁽¹⁾	PACKAGE	PIN	BODY SIZE (NOM)	MOUNTING TYPE
LMT85DCK	SOT (AKA ⁽²⁾ : SC70, DCK)	5	2.00 mm × 1.25 mm	Surface Mount
LMT85LP	TO-92 (AKA ⁽²⁾ : LP)	3	4.30 mm × 3.50 mm	Through-hole; straight leads
LMT85LPG	TO-92S (AKA ⁽²⁾ : LPG)	3	4.00 mm × 3.15 mm	Through-hole; straight leads
LMT85LPM	TO-92 (AKA ⁽²⁾ : LPM)	3	4.30 mm × 3.50 mm	Through-hole; formed leads
LMT85DCK-Q1	SOT (AKA ⁽²⁾ : SC70, DCK)	5	2.00 mm × 1.25 mm	Surface Mount

(1) For all available packages and complete order numbers, see the Package Option addendum at the end of the data sheet.

(2) AKA = Also Known As

Table 2. Comparable Alternative Devices

DEVICE NAME	AVERAGE OUTPUT SENSOR GAIN	POWER SUPPLY RANGE
LMT84-Q1	-5.5 mV/°C	1.5 V to 5.5 V
LMT85-Q1	-8.2 mV/°C	1.8 V to 5.5 V
LMT86-Q1	-10.9 mV/°C	2.2 V to 5.5 V
LMT87-Q1	-13.6 mV/°C	2.7 V to 5.5 V

6 Pin Configuration and Functions

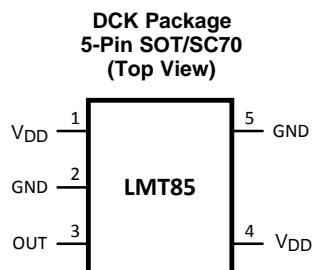

Pin Functions

PIN		TYPE	DESCRIPTION	
NAME	SOT (SC70)		EQUIVALENT CIRCUIT	FUNCTION
GND	2 ⁽¹⁾ , 5	Ground	N/A	Power Supply Ground
OUT	3	Analog Output		Outputs a voltage that is inversely proportional to temperature
V _{DD}	1, 4	Power	N/A	Positive Supply Voltage

(1) Direct connection to the back side of the die

7 Specifications

7.1 Absolute Maximum Ratings

 See ⁽¹⁾⁽²⁾

	MIN	MAX	UNIT
Supply voltage	-0.3	6	V
Voltage at output pin	-0.3	(V _{DD} + 0.5)	V
Output current	-7	7	mA
Input current at any pin ⁽³⁾	-5	5	mA
Maximum junction temperature (T _{JMAX})		150	°C
Storage temperature, T _{stg}	-65	150	°C

- (1) Stresses beyond those listed under *Absolute Maximum Ratings* may cause permanent damage to the device. These are stress ratings only, which do not imply functional operation of the device at these or any other conditions beyond those indicated under *Recommended Operating Conditions*. Exposure to absolute-maximum-rated conditions for extended periods may affect device reliability.
- (2) Soldering process must comply with Reflow Temperature Profile specifications. Refer to www.ti.com/packaging.
- (3) When the input voltage (V_I) at any pin exceeds power supplies (V_I < GND or V_I > V), the current at that pin should be limited to 5 mA.

7.2 ESD Ratings

		VALUE	UNIT
LMT85DCK-Q1 in SC70 package			
V _(ESD)	Electrostatic discharge	Human-body model (HBM), per AEC Q100-002 ⁽¹⁾	±2500
		Charged-device model (CDM), per AEC Q100-011	±1000

- (1) AEC Q100-002 indicates that HBM stressing shall be in accordance with the ANSI/ESDA/JEDEC JS-001 specification.

7.3 Recommended Operating Conditions

	MIN	MAX	UNIT
Specified temperature	T _{MIN} ≤ T _A ≤ T _{MAX}		°C
	-50 ≤ T _A ≤ 150		°C
Supply voltage (V _{DD})	1.8	5.5	V

7.4 Thermal Information⁽¹⁾

THERMAL METRIC ⁽²⁾		LMT85-Q1	UNIT
		DCK (SOT/SC70)	
		5 PINS	
R _{θJA}	Junction-to-ambient thermal resistance ⁽³⁾⁽⁴⁾	275	°C/W
R _{θJC(top)}	Junction-to-case (top) thermal resistance	84	°C/W
R _{θJB}	Junction-to-board thermal resistance	56	°C/W
ψ _{JT}	Junction-to-top characterization parameter	1.2	°C/W
ψ _{JB}	Junction-to-board characterization parameter	55	°C/W

- (1) For information on self-heating and thermal response time, see section [Mounting and Thermal Conductivity](#).
- (2) For more information about traditional and new thermal metrics, see the [IC Package Thermal Metrics](#) application report.
- (3) The junction to ambient thermal resistance (R_{θJA}) under natural convection is obtained in a simulation on a JEDEC-standard, High-K board as specified in JESD51-7, in an environment described in JESD51-2. Exposed pad packages assume that thermal vias are included in the PCB, per JESD 51-5.
- (4) Changes in output due to self-heating can be computed by multiplying the internal dissipation by the thermal resistance.

7.5 Accuracy Characteristics

These limits do not include DC load regulation. These stated accuracy limits are with reference to the values in [Table 3](#).

PARAMETER	TEST CONDITIONS	MIN ⁽¹⁾	TYP ⁽²⁾	MAX ⁽¹⁾	UNIT
Temperature accuracy ⁽³⁾	$T_A = T_J = 20^\circ\text{C}$ to 150°C ; $V_{DD} = 1.8\text{ V}$ to 5.5 V	-2.7	±0.4	2.7	°C
	$T_A = T_J = 0^\circ\text{C}$ to 150°C ; $V_{DD} = 1.9\text{ V}$ to 5.5 V	-2.7	±0.7	2.7	°C
	$T_A = T_J = 0^\circ\text{C}$ to 150°C ; $V_{DD} = 2.6\text{ V}$ to 5.5 V		±0.3		°C
	$T_A = T_J = -50^\circ\text{C}$ to 0°C ; $V_{DD} = 2.3\text{ V}$ to 5.5 V	-2.7	±0.7	2.7	°C
	$T_A = T_J = -50^\circ\text{C}$ to 0°C ; $V_{DD} = 2.9\text{ V}$ to 5.5 V		±0.25		°C

- (1) Limits are specific to TI's AOQL (Average Outgoing Quality Level).
- (2) Typical values are at $T_J = T_A = 25^\circ\text{C}$ and represent most likely parametric norm.
- (3) Accuracy is defined as the error between the measured and reference output voltages, tabulated in the Transfer Table at the specified conditions of supply gain setting, voltage, and temperature (expressed in °C). Accuracy limits include line regulation within the specified conditions. Accuracy limits do not include load regulation; they assume no DC load.

7.6 Electrical Characteristics

Unless otherwise noted, these specifications apply for $V_{DD} = +1.8\text{V}$ to $+5.5\text{V}$. MIN and MAX limits apply for $T_A = T_J = T_{MIN}$ to T_{MAX} , unless otherwise noted; typical values apply for $T_A = T_J = 25^\circ\text{C}$.

PARAMETER	TEST CONDITIONS	MIN ⁽¹⁾	TYP ⁽²⁾	MAX ⁽¹⁾	UNIT
Average sensor gain (output transfer function slope)	-30°C and 90°C used to calculate average sensor gain		-8.2		mV/°C
Load regulation ⁽³⁾	Source $\leq 50\ \mu\text{A}$, $(V_{DD} - V_{OUT}) \geq 200\text{ mV}$	-1	-0.22		mV
	Sink $\leq 50\ \mu\text{A}$, $V_{OUT} \geq 200\text{ mV}$		0.26	1	mV
Line regulation ⁽⁴⁾			200		$\mu\text{V/V}$
I_S Supply current	$T_A = T_J = 30^\circ\text{C}$ to 150°C , $(V_{DD} - V_{OUT}) \geq 100\text{ mV}$		5.4	8.1	μA
	$T_A = T_J = -50^\circ\text{C}$ to 150°C , $(V_{DD} - V_{OUT}) \geq 100\text{ mV}$		5.4	9	μA
C_L Output load capacitance			1100		pF
Power-on time ⁽⁵⁾	$C_L = 0\text{ pF}$ to 1100 pF		0.7	1.9	ms
Output drive	$T_A = T_J = 25^\circ\text{C}$	-50		+50	μA

- (1) Limits are specific to TI's AOQL (Average Outgoing Quality Level).
- (2) Typical values are at $T_J = T_A = 25^\circ\text{C}$ and represent most likely parametric norm.
- (3) Source currents are flowing out of the LMT85-Q1. Sink currents are flowing into the LMT85-Q1.
- (4) Line regulation (DC) is calculated by subtracting the output voltage at the highest supply voltage from the output voltage at the lowest supply voltage. The typical DC line regulation specification does not include the output voltage shift discussed in [Output Voltage Shift](#).
- (5) Specified by design and characterization.

7.7 Typical Characteristics

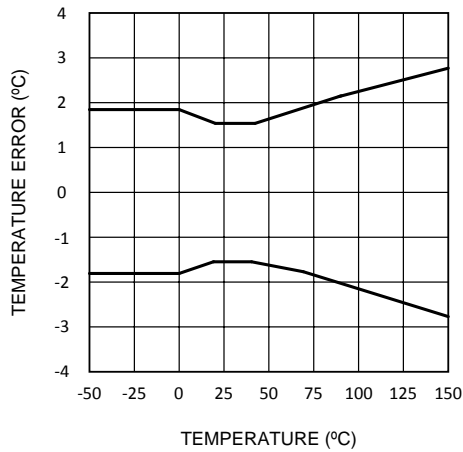

Figure 1. Temperature Error vs Temperature

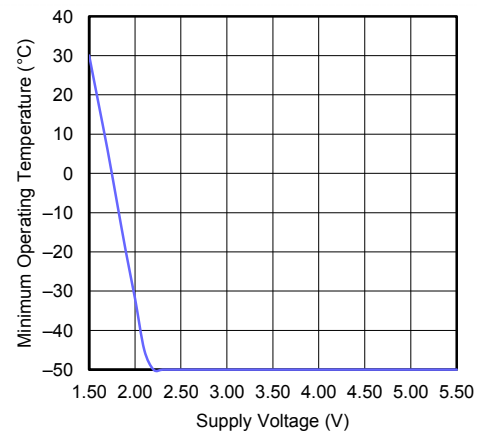

Figure 2. Minimum Operating Temperature vs Supply Voltage

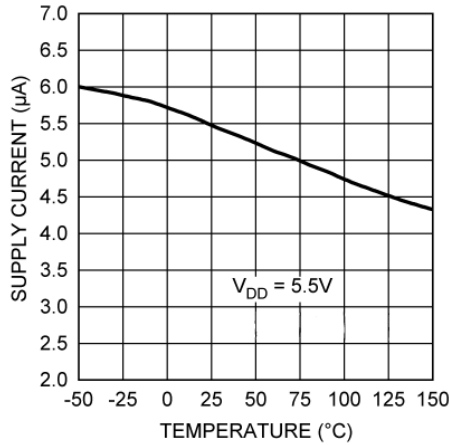

Figure 3. Supply Current vs Temperature

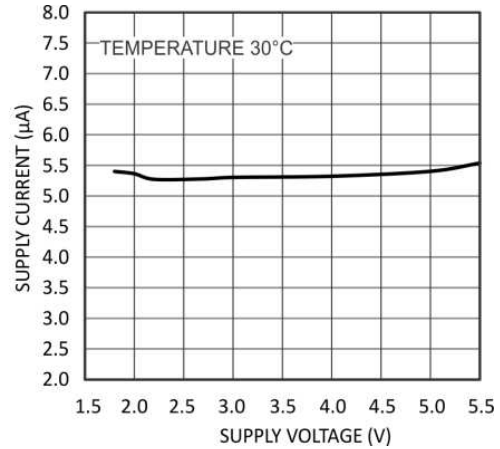

Figure 4. Supply Current vs Supply Voltage

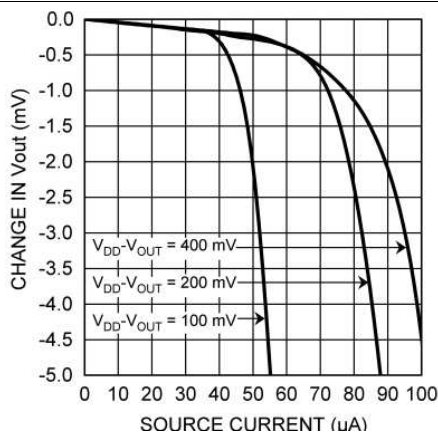

Figure 5. Load Regulation, Sourcing Current

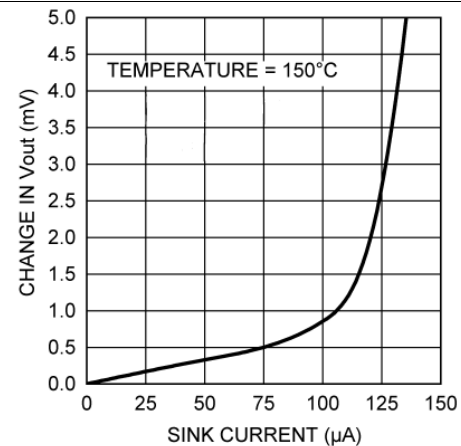

Figure 6. Load Regulation, Sinking Current

Typical Characteristics (continued)

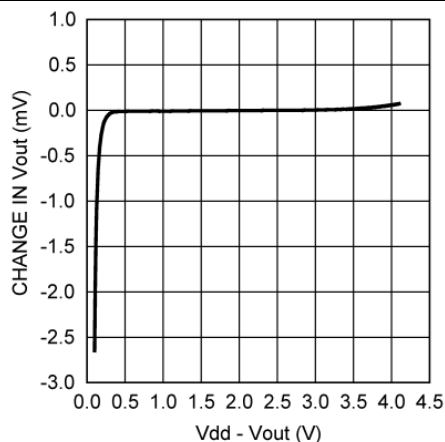

Figure 7. Change in Vout vs Overhead Voltage

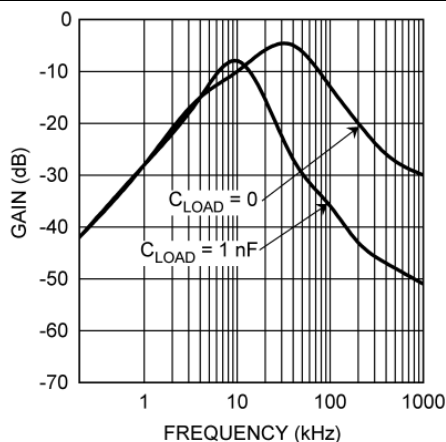

Figure 8. Supply-Noise Gain vs Frequency

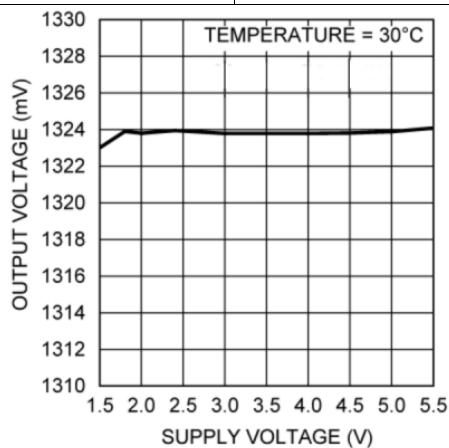

Figure 9. Output Voltage vs Supply Voltage

8 Detailed Description

8.1 Overview

The LMT85-Q1 is an analog output temperature sensor. The temperature sensing element is comprised of a simple base emitter junction that is forward biased by a current source. The temperature-sensing element is then buffered by an amplifier and provided to the OUT pin. The amplifier has a simple push-pull output stage thus providing a low impedance output source.

8.2 Functional Block Diagram

Full-Range Celsius Temperature Sensor (-50°C to 150°C).

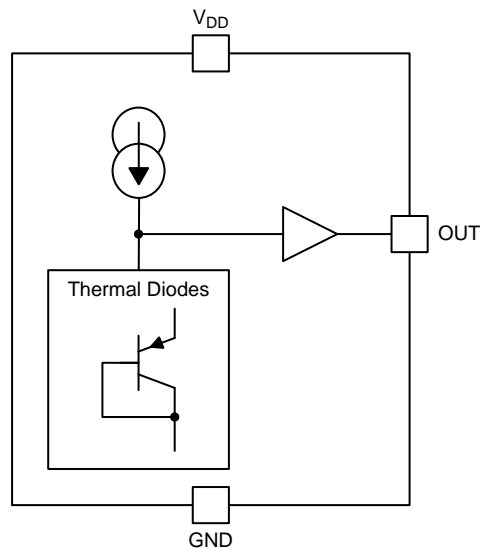

8.3 Feature Description

8.3.1 LMT85-Q1 Transfer Function

The output voltage of the LMT85-Q1, across the complete operating temperature range, is shown in [Table 3](#). This table is the reference from which the LMT85 accuracy specifications (listed in the [Accuracy Characteristics](#) section) are determined. This table can be used, for example, in a host processor look-up table. A file containing this data is available for download at the [LMT85-Q1](#) product folder under *Tools and Software Models*.

Table 3. LMT85-Q1 Transfer Table

TEMP (°C)	V _{OUT} (mV)	TEMP (°C)	V _{OUT} (mV)	TEMP (°C)	V _{OUT} (mV)	TEMP (°C)	V _{OUT} (mV)	TEMP (°C)	V _{OUT} (mV)
-50	1955	-10	1648	30	1324	70	991	110	651
-49	1949	-9	1639	31	1316	71	983	111	642
-48	1942	-8	1631	32	1308	72	974	112	634
-47	1935	-7	1623	33	1299	73	966	113	625
-46	1928	-6	1615	34	1291	74	957	114	617
-45	1921	-5	1607	35	1283	75	949	115	608
-44	1915	-4	1599	36	1275	76	941	116	599
-43	1908	-3	1591	37	1267	77	932	117	591
-42	1900	-2	1583	38	1258	78	924	118	582
-41	1892	-1	1575	39	1250	79	915	119	573
-40	1885	0	1567	40	1242	80	907	120	565
-39	1877	1	1559	41	1234	81	898	121	556
-38	1869	2	1551	42	1225	82	890	122	547

Feature Description (continued)
Table 3. LMT85-Q1 Transfer Table (continued)

TEMP (°C)	V _{OUT} (mV)	TEMP (°C)	V _{OUT} (mV)	TEMP (°C)	V _{OUT} (mV)	TEMP (°C)	V _{OUT} (mV)	TEMP (°C)	V _{OUT} (mV)
-37	1861	3	1543	43	1217	83	881	123	539
-36	1853	4	1535	44	1209	84	873	124	530
-35	1845	5	1527	45	1201	85	865	125	521
-34	1838	6	1519	46	1192	86	856	126	513
-33	1830	7	1511	47	1184	87	848	127	504
-32	1822	8	1502	48	1176	88	839	128	495
-31	1814	9	1494	49	1167	89	831	129	487
-30	1806	10	1486	50	1159	90	822	130	478
-29	1798	11	1478	51	1151	91	814	131	469
-28	1790	12	1470	52	1143	92	805	132	460
-27	1783	13	1462	53	1134	93	797	133	452
-26	1775	14	1454	54	1126	94	788	134	443
-25	1767	15	1446	55	1118	95	779	135	434
-24	1759	16	1438	56	1109	96	771	136	425
-23	1751	17	1430	57	1101	97	762	137	416
-22	1743	18	1421	58	1093	98	754	138	408
-21	1735	19	1413	59	1084	99	745	139	399
-20	1727	20	1405	60	1076	100	737	140	390
-19	1719	21	1397	61	1067	101	728	141	381
-18	1711	22	1389	62	1059	102	720	142	372
-17	1703	23	1381	63	1051	103	711	143	363
-16	1695	24	1373	64	1042	104	702	144	354
-15	1687	25	1365	65	1034	105	694	145	346
-14	1679	26	1356	66	1025	106	685	146	337
-13	1671	27	1348	67	1017	107	677	147	328
-12	1663	28	1340	68	1008	108	668	148	319
-11	1656	29	1332	69	1000	109	660	149	310
								150	301

Although the LMT85-Q1 is very linear, its response does have a slight umbrella parabolic shape. This shape is very accurately reflected in [Table 3](#). The Transfer Table can be calculated by using the parabolic equation ([Equation 1](#)).

$$V_{TEMP} (mV) = 1324.0mV - \left[8.194 \frac{mV}{^{\circ}C} (T - 30^{\circ}C) \right] - \left[0.00262 \frac{mV}{^{\circ}C^2} (T - 30^{\circ}C)^2 \right] \quad (1)$$

The parabolic equation is an approximation of the transfer table and the accuracy of the equation degrades slightly at the temperature range extremes. [Equation 1](#) can be solved for T resulting in:

$$T = \frac{8.194 - \sqrt{(-8.194)^2 + 4 \times 0.00262 \times (1324 - V_{TEMP} (mV))}}{2 \times -0.00262} + 30 \quad (2)$$

For an even less accurate linear transfer function approximation, a line can easily be calculated over the desired temperature range using values from the Table and a two-point equation ([Equation 3](#)):

$$V - V_1 = \left(\frac{V_2 - V_1}{T_2 - T_1} \right) \times (T - T_1)$$

where

- V is in mV,
 - T is in °C,
 - T₁ and V₁ are the coordinates of the lowest temperature,
 - and T₂ and V₂ are the coordinates of the highest temperature.
- (3)

For example, if the user wanted to resolve this equation, over a temperature range of 20°C to 50°C, they would proceed as follows:

$$V - 1405 \text{ mV} = \left(\frac{1159 \text{ mV} - 1405 \text{ mV}}{50^\circ\text{C} - 20^\circ\text{C}} \right) \times (T - 20^\circ\text{C}) \quad (4)$$

$$V - 1405 \text{ mV} = (-8.20 \text{ mV} / ^\circ\text{C}) \times (T - 20^\circ\text{C}) \quad (5)$$

$$V = (-8.20 \text{ mV} / ^\circ\text{C}) \times T + 1569 \text{ mV} \quad (6)$$

Using this method of linear approximation, the transfer function can be approximated for one or more temperature ranges of interest.

8.4 Device Functional Modes

8.4.1 Mounting and Thermal Conductivity

The LMT85-Q1 can be applied easily in the same way as other integrated-circuit temperature sensors. It can be glued or cemented to a surface.

To ensure good thermal conductivity, the backside of the LMT85 die is directly attached to the GND pin. The temperatures of the lands and traces to the other leads of the LMT85-Q1 will also affect the temperature reading.

Alternatively, the LMT85-Q1 can be mounted inside a sealed-end metal tube, and can then be dipped into a bath or screwed into a threaded hole in a tank. As with any IC, the LMT85-Q1 and accompanying wiring and circuits must be kept insulated and dry, to avoid leakage and corrosion. This is especially true if the circuit may operate at cold temperatures where condensation can occur. If moisture creates a short circuit from the output to ground or V_{DD} , the output from the LMT85 will not be correct. Printed-circuit coatings are often used to ensure that moisture cannot corrode the leads or circuit traces.

The thermal resistance junction to ambient ($R_{\theta JA}$ or θ_{JA}) is the parameter used to calculate the rise of a device junction temperature due to its power dissipation. Use [Equation 7](#) to calculate the rise in the LMT85-Q1 die temperature:

$$T_J = T_A + \theta_{JA} [(V_{DD}I_S) + (V_{DD} - V_{OUT}) I_L]$$

where

- T_A is the ambient temperature,
- I_S is the supply current,
- I_L is the load current on the output,
- and V_O is the output voltage. (7)

For example, in an application where $T_A = 30^\circ\text{C}$, $V_{DD} = 5 \text{ V}$, $I_S = 5.4 \mu\text{A}$, $V_{OUT} = 1324 \text{ mV}$, and $I_L = 2 \mu\text{A}$, the junction temperature would be 30.014°C , showing a self-heating error of only 0.014°C . Because the junction temperature of the LMT85-Q1 is the actual temperature being measured, take care to minimize the load current that the LMT85-Q1 is required to drive. [Thermal Information](#) shows the thermal resistance of the LMT85-Q1.

8.4.2 Output and Noise Considerations

A push-pull output gives the LMT85-Q1 the ability to sink and source significant current. This is beneficial when, for example, driving dynamic loads like an input stage on an analog-to-digital converter (ADC). In these applications the source current is required to quickly charge the input capacitor of the ADC. The LMT85-Q1 device is ideal for this and other applications which require strong source or sink current.

The LMT85-Q1 supply-noise gain (the ratio of the AC signal on V_{OUT} to the AC signal on V_{DD}) was measured during bench tests. The typical attenuation is shown in [Figure 8](#) found in the [Typical Characteristics](#). A load capacitor on the output can help to filter noise.

For operation in very noisy environments, some bypass capacitance should be present on the supply within approximately 5 centimeters of the LMT85-Q1.

Device Functional Modes (continued)

8.4.3 Capacitive Loads

The LMT85-Q1 handles capacitive loading well. In an extremely noisy environment, or when driving a switched sampling input on an ADC, it may be necessary to add some filtering to minimize noise coupling. Without any precautions, the LMT85-Q1 can drive a capacitive load less than or equal to 1100 pF as shown in Figure 10. For capacitive loads greater than 1100 pF, a series resistor may be required on the output, as shown in Figure 11.

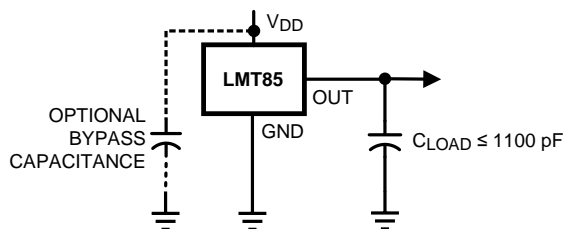

Figure 10. LMT85-Q1 No Decoupling Required for Capacitive Loads Less Than 1100 pF

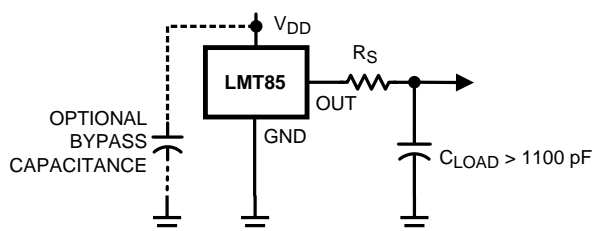

Figure 11. LMT85-Q1 with Series Resistor for Capacitive Loading Greater Than 1100 pF

Table 4. Recommended Series Resistor Values

C _{LOAD}	MINIMUM R _S
1.1 nF to 99 nF	3 kΩ
100 nF to 999 nF	1.5 kΩ
1 μF	800 Ω

8.4.4 Output Voltage Shift

The LMT85-Q1 is very linear over temperature and supply voltage range. Due to the intrinsic behavior of an NMOS/PMOS rail-to-rail buffer, a slight shift in the output can occur when the supply voltage is ramped over the operating range of the device. The location of the shift is determined by the relative levels of V_{DD} and V_{OUT}. The shift typically occurs when V_{DD} - V_{OUT} = 1 V.

This slight shift (a few millivolts) takes place over a wide change (approximately 200 mV) in V_{DD} or V_{OUT}. Because the shift takes place over a wide temperature change of 5°C to 20°C, V_{OUT} is always monotonic. The accuracy specifications in the [Accuracy Characteristics](#) table already include this possible shift.

9 Application and Implementation

NOTE

Information in the following applications sections is not part of the TI component specification, and TI does not warrant its accuracy or completeness. TI's customers are responsible for determining suitability of components for their purposes. Customers should validate and test their design implementation to confirm system functionality.

9.1 Application Information

The LMT85-Q1 features make it suitable for many general temperature-sensing applications. It can operate down to 1.8-V supply with 5.4- μ A power consumption, making it ideal for battery powered devices.

9.2 Typical Applications

9.2.1 Connection to an ADC

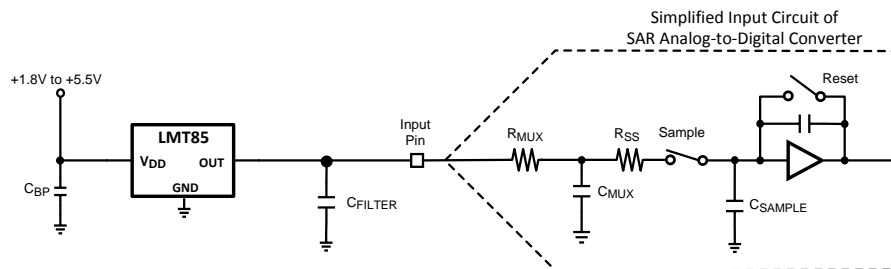

Figure 12. Suggested Connection to a Sampling Analog-to-Digital Converter Input Stage

9.2.1.1 Design Requirements

Most CMOS ADCs found in microcontrollers and ASICs have a sampled data comparator input structure. When the ADC charges the sampling cap, it requires instantaneous charge from the output of the analog source such as the LMT85 temperature sensor and many op amps. This requirement is easily accommodated by the addition of a capacitor (C_{FILTER}).

9.2.1.2 Detailed Design Procedure

The size of C_{FILTER} depends on the size of the sampling capacitor and the sampling frequency. Because not all ADCs have identical input stages, the charge requirements will vary. This general ADC application is shown as an example only.

9.2.1.3 Application Curve

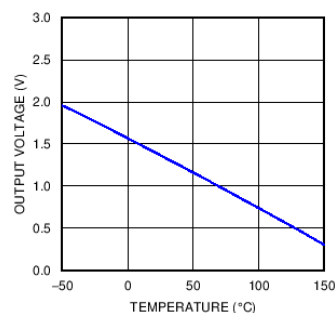

Figure 13. Analog Output Transfer Function

Typical Applications (continued)

9.2.2 Conserving Power Dissipation With Shutdown

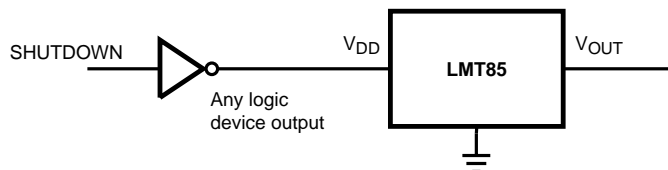

Figure 14. Simple Shutdown Connection of the LMT85-Q1

9.2.2.1 Design Requirements

Because the power consumption of the LMT85-Q1 is less than 9 μA , it can simply be powered directly from any logic gate output and therefore not require a specific shutdown pin. The device can even be powered directly from a micro controller GPIO. In this way, it can easily be turned off for cases such as battery-powered systems where power savings are critical.

9.2.2.2 Detailed Design Procedure

Simply connect the V_{DD} pin of the LMT85-Q1 directly to the logic shutdown signal from a microcontroller.

9.2.2.3 Application Curves

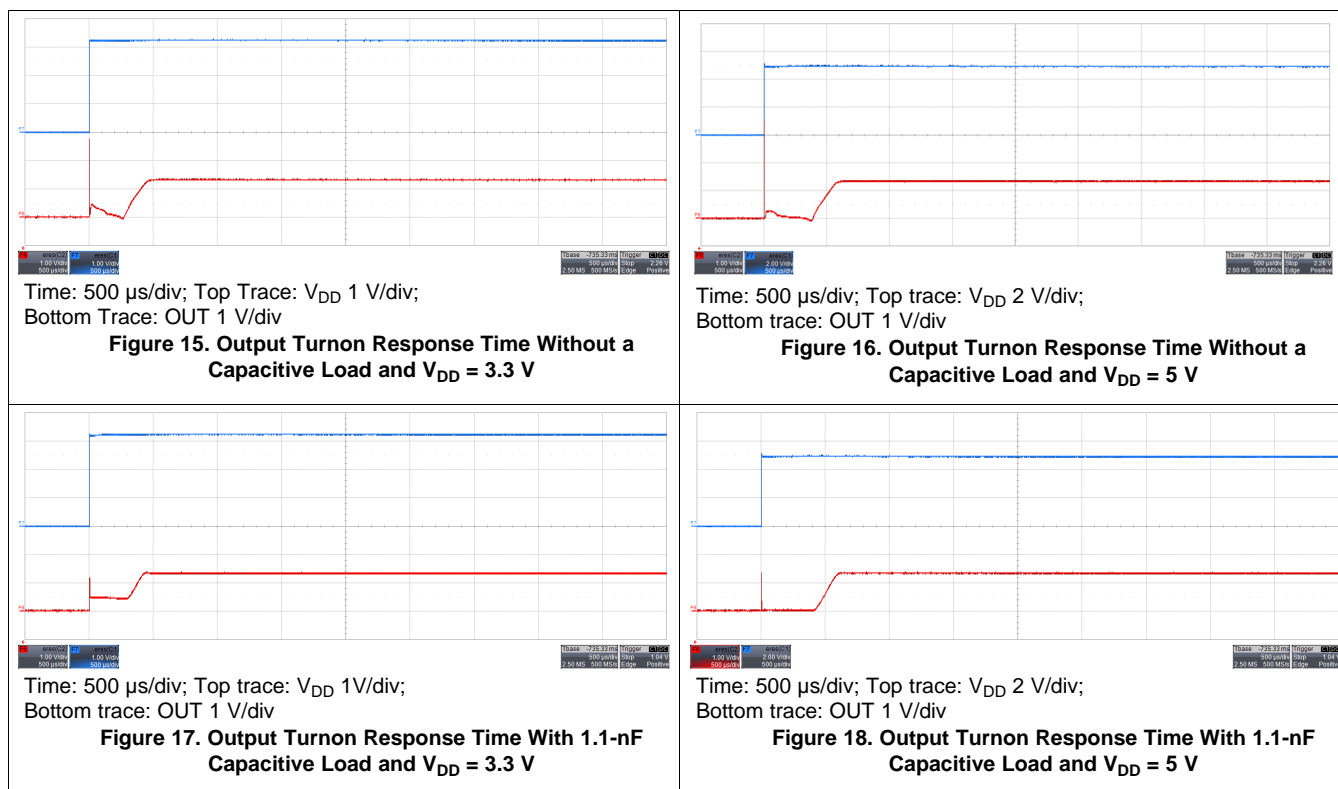

10 Power Supply Recommendations

The low supply current and supply range (1.8 V to 5.5 V) of the LMT85-Q1 allow the device to easily be powered from many sources. Power supply bypassing is optional and is mainly dependent on the noise on the power supply used. In noisy systems it may be necessary to add bypass capacitors to lower the noise that is coupled to the output of the LMT85-Q1.

11 Layout

11.1 Layout Guidelines

The LMT85-Q1 is extremely simple to layout. If a power-supply bypass capacitor is used, it should be connected as shown in the [Layout Example](#)

11.2 Layout Example

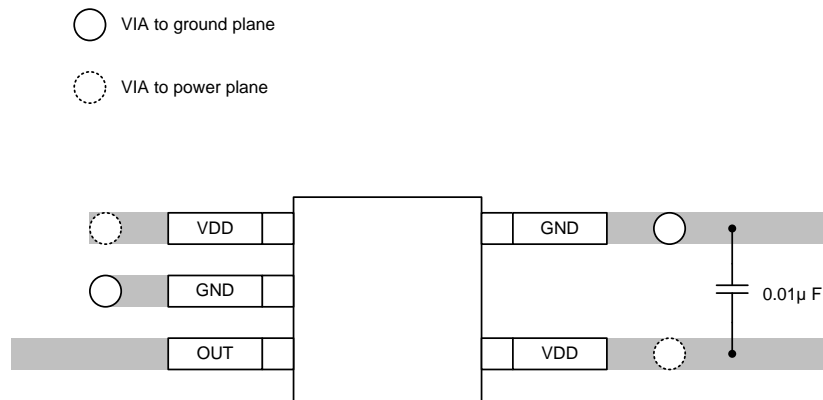

Figure 19. SC70 Package Recommended Layout

12 Device and Documentation Support

12.1 Receiving Notification of Documentation Updates

To receive notification of documentation updates, navigate to the device product folder on ti.com. In the upper right corner, click on *Alert me* to register and receive a weekly digest of any product information that has changed. For change details, review the revision history included in any revised document.

12.2 Community Resources

The following links connect to TI community resources. Linked contents are provided "AS IS" by the respective contributors. They do not constitute TI specifications and do not necessarily reflect TI's views; see TI's [Terms of Use](#).

TI E2E™ Online Community *TI's Engineer-to-Engineer (E2E) Community*. Created to foster collaboration among engineers. At e2e.ti.com, you can ask questions, share knowledge, explore ideas and help solve problems with fellow engineers.

Design Support *TI's Design Support* Quickly find helpful E2E forums along with design support tools and contact information for technical support.

12.3 Trademarks

E2E is a trademark of Texas Instruments.
All other trademarks are the property of their respective owners.

12.4 Electrostatic Discharge Caution



These devices have limited built-in ESD protection. The leads should be shorted together or the device placed in conductive foam during storage or handling to prevent electrostatic damage to the MOS gates.

12.5 Glossary

[SLYZ022](#) — *TI Glossary*.

This glossary lists and explains terms, acronyms, and definitions.

13 Mechanical, Packaging, and Orderable Information

The following pages include mechanical, packaging, and orderable information. This information is the most current data available for the designated devices. This data is subject to change without notice and revision of this document. For browser-based versions of this data sheet, refer to the left-hand navigation.

PACKAGING INFORMATION

Orderable Device	Status (1)	Package Type	Package Drawing	Pins	Package Qty	Eco Plan (2)	Lead/Ball Finish (6)	MSL Peak Temp (3)	Op Temp (°C)	Device Marking (4/5)	Samples
LMT85QDCKRQ1	ACTIVE	SC70	DCK	5	3000	Green (RoHS & no Sb/Br)	SN	Level-1-260C-UNLIM	-50 to 150	BRA	Samples
LMT85QDCKTQ1	ACTIVE	SC70	DCK	5	250	Green (RoHS & no Sb/Br)	SN	Level-1-260C-UNLIM	-50 to 150	BRA	Samples

(1) The marketing status values are defined as follows:

ACTIVE: Product device recommended for new designs.

LIFEBUY: TI has announced that the device will be discontinued, and a lifetime-buy period is in effect.

NRND: Not recommended for new designs. Device is in production to support existing customers, but TI does not recommend using this part in a new design.

PREVIEW: Device has been announced but is not in production. Samples may or may not be available.

OBsolete: TI has discontinued the production of the device.

(2) **RoHS:** TI defines "RoHS" to mean semiconductor products that are compliant with the current EU RoHS requirements for all 10 RoHS substances, including the requirement that RoHS substance do not exceed 0.1% by weight in homogeneous materials. Where designed to be soldered at high temperatures, "RoHS" products are suitable for use in specified lead-free processes. TI may reference these types of products as "Pb-Free".

RoHS Exempt: TI defines "RoHS Exempt" to mean products that contain lead but are compliant with EU RoHS pursuant to a specific EU RoHS exemption.

Green: TI defines "Green" to mean the content of Chlorine (Cl) and Bromine (Br) based flame retardants meet JS709B low halogen requirements of <=1000ppm threshold. Antimony trioxide based flame retardants must also meet the <=1000ppm threshold requirement.

(3) MSL, Peak Temp. - The Moisture Sensitivity Level rating according to the JEDEC industry standard classifications, and peak solder temperature.

(4) There may be additional marking, which relates to the logo, the lot trace code information, or the environmental category on the device.

(5) Multiple Device Markings will be inside parentheses. Only one Device Marking contained in parentheses and separated by a "~" will appear on a device. If a line is indented then it is a continuation of the previous line and the two combined represent the entire Device Marking for that device.

(6) Lead/Ball Finish - Orderable Devices may have multiple material finish options. Finish options are separated by a vertical ruled line. Lead/Ball Finish values may wrap to two lines if the finish value exceeds the maximum column width.

Important Information and Disclaimer:The information provided on this page represents TI's knowledge and belief as of the date that it is provided. TI bases its knowledge and belief on information provided by third parties, and makes no representation or warranty as to the accuracy of such information. Efforts are underway to better integrate information from third parties. TI has taken and continues to take reasonable steps to provide representative and accurate information but may not have conducted destructive testing or chemical analysis on incoming materials and chemicals. TI and TI suppliers consider certain information to be proprietary, and thus CAS numbers and other limited information may not be available for release.

In no event shall TI's liability arising out of such information exceed the total purchase price of the TI part(s) at issue in this document sold by TI to Customer on an annual basis.

OTHER QUALIFIED VERSIONS OF LMT85-Q1 :

- Catalog: [LMT85](#)

NOTE: Qualified Version Definitions:

- Catalog - TI's standard catalog product

TAPE AND REEL INFORMATION

QUADRANT ASSIGNMENTS FOR PIN 1 ORIENTATION IN TAPE

*All dimensions are nominal

Device	Package Type	Package Drawing	Pins	SPQ	Reel Diameter (mm)	Reel Width W1 (mm)	A0 (mm)	B0 (mm)	K0 (mm)	P1 (mm)	W (mm)	Pin1 Quadrant
LMT85QDCKRQ1	SC70	DCK	5	3000	178.0	8.4	2.25	2.45	1.2	4.0	8.0	Q3
LMT85QDCKTQ1	SC70	DCK	5	250	178.0	8.4	2.25	2.45	1.2	4.0	8.0	Q3

TAPE AND REEL BOX DIMENSIONS

*All dimensions are nominal

Device	Package Type	Package Drawing	Pins	SPQ	Length (mm)	Width (mm)	Height (mm)
LMT85QDCKRQ1	SC70	DCK	5	3000	210.0	185.0	35.0
LMT85QDCKTQ1	SC70	DCK	5	250	210.0	185.0	35.0

DCK (R-PDSO-G5)

PLASTIC SMALL-OUTLINE PACKAGE



- NOTES:
- A. All linear dimensions are in millimeters.
 - B. This drawing is subject to change without notice.
 - C. Body dimensions do not include mold flash or protrusion. Mold flash and protrusion shall not exceed 0.15 per side.
 - D. Falls within JEDEC MO-203 variation AA.

DCK (R-PDSO-G5)

PLASTIC SMALL OUTLINE



- NOTES:
- All linear dimensions are in millimeters.
 - This drawing is subject to change without notice.
 - Customers should place a note on the circuit board fabrication drawing not to alter the center solder mask defined pad.
 - Publication IPC-7351 is recommended for alternate designs.
 - Laser cutting apertures with trapezoidal walls and also rounding corners will offer better paste release. Customers should contact their board assembly site for stencil design recommendations. Example stencil design based on a 50% volumetric metal load solder paste. Refer to IPC-7525 for other stencil recommendations.

IMPORTANT NOTICE AND DISCLAIMER

TI PROVIDES TECHNICAL AND RELIABILITY DATA (INCLUDING DATASHEETS), DESIGN RESOURCES (INCLUDING REFERENCE DESIGNS), APPLICATION OR OTHER DESIGN ADVICE, WEB TOOLS, SAFETY INFORMATION, AND OTHER RESOURCES "AS IS" AND WITH ALL FAULTS, AND DISCLAIMS ALL WARRANTIES, EXPRESS AND IMPLIED, INCLUDING WITHOUT LIMITATION ANY IMPLIED WARRANTIES OF MERCHANTABILITY, FITNESS FOR A PARTICULAR PURPOSE OR NON-INFRINGEMENT OF THIRD PARTY INTELLECTUAL PROPERTY RIGHTS.

These resources are intended for skilled developers designing with TI products. You are solely responsible for (1) selecting the appropriate TI products for your application, (2) designing, validating and testing your application, and (3) ensuring your application meets applicable standards, and any other safety, security, or other requirements. These resources are subject to change without notice. TI grants you permission to use these resources only for development of an application that uses the TI products described in the resource. Other reproduction and display of these resources is prohibited. No license is granted to any other TI intellectual property right or to any third party intellectual property right. TI disclaims responsibility for, and you will fully indemnify TI and its representatives against, any claims, damages, costs, losses, and liabilities arising out of your use of these resources.

TI's products are provided subject to TI's Terms of Sale (www.ti.com/legal/termsofsale.html) or other applicable terms available either on ti.com or provided in conjunction with such TI products. TI's provision of these resources does not expand or otherwise alter TI's applicable warranties or warranty disclaimers for TI products.

Mailing Address: Texas Instruments, Post Office Box 655303, Dallas, Texas 75265
Copyright © 2020, Texas Instruments Incorporated