

2-W STEREO AUDIO POWER AMPLIFIER WITH DirectPath™ STEREO HEADPHONE DRIVE AND REGULATOR

FEATURES

- Microsoft™ Windows Vista™ Compliant
- Fully Differential Architecture and High PSRR Provide Excellent RF Rectification Immunity
- 2.1-W, 1% THD+N Into 4-Ω Speakers and 100-mW, 10% THD+N Into 16-Ω Headphones From 5-V Supply
- DirectPath™ Headphone Amplifier Eliminates Output Capacitors ⁽¹⁾
- Internal 4-Step Speaker Gain Control: 10, 12, 15.6, 21.6 dB and Fixed -1.5-V/V Headphone
- 4.75-V Low Dropout Regulator for CODEC
- Independent Shutdown Controls for Speaker, Headphone Amplifier, and Low Dropout Regulator (LDO)
- Output Short-Circuit and Thermal Protection

DESCRIPTION

The TPA6047A4 is a stereo audio power amplifier and DirectPath™ headphone amplifier in a thermally enhanced, space-saving, 32-pin QFN package. The speaker amplifier is capable of driving 2.1 W per channel continuously into 4-Ω loads at 5 V. The headphone amplifier achieves a minimum of 100 mW at 10% THD+N from a 5-V supply. A built-in internal 4-step gain control for the speaker amplifier and a fixed -1.5 V/V gain for the headphone amplifier minimizes external components needed.

Independent shutdown control and dedicated inputs for the speaker and headphone allow the TPA6047A4 to simultaneously drive both headphones and internal speakers. Differential inputs to the speaker amplifiers offer superior power-supply and common-mode noise rejection.

APPLICATIONS

- Notebook Computers
- Portable DVD

SIMPLIFIED APPLICATION CIRCUIT

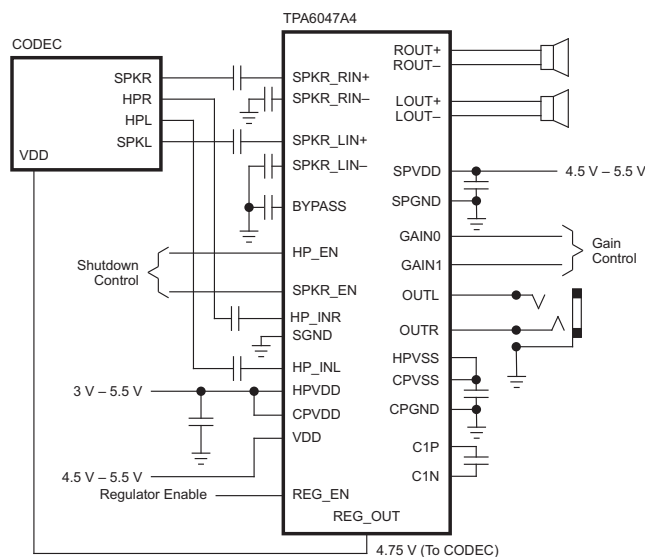

(1) US Patent Number 5289137

| | TPA6040A4 | TPA6041A4 | TPA6047A4 |
|-----------------------|-------------------|--------------------|--------------------|
| Speaker Enable | Active Low | Active Low | Active High |
| LDO (V) | 4.75 | 3.3 | 4.75 |
| Gain (dB) | 6, 10, 15.6, 21.6 | 10, 12, 15.6, 21.6 | 10, 12, 15.6, 21.6 |



Please be aware that an important notice concerning availability, standard warranty, and use in critical applications of Texas Instruments semiconductor products and disclaimers thereto appears at the end of this data sheet.

DirectPath, PowerPAD are trademarks of Texas Instruments.
Microsoft, Windows Vista are trademarks of Microsoft Corporation.



These devices have limited built-in ESD protection. The leads should be shorted together or the device placed in conductive foam during storage or handling to prevent electrostatic damage to the MOS gates.

Functional Block Diagram

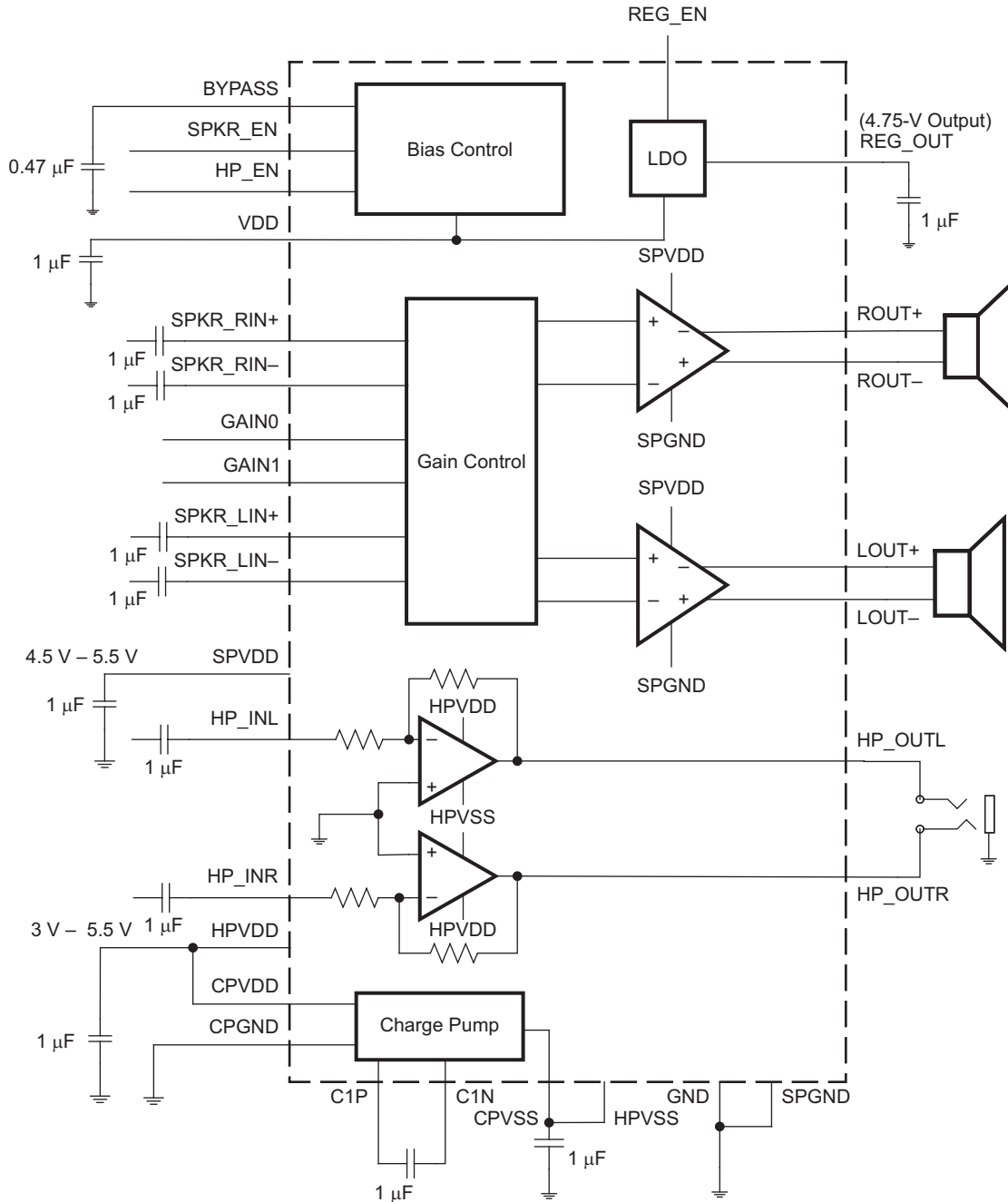

AVAILABLE PACKAGE OPTIONS

| T _A | PACKAGED DEVICE ⁽¹⁾⁽²⁾ 32-Pin QFN (RHB) |
|----------------|---|
| –40°C to 85°C | TPA6047A4RHB |

- (1) The RHB package is available taped and reeled. To order a taped and reeled part, add the suffix R to the part number (e.g., TPA6047A4RHBR).
- (2) For the most current package and ordering information, see the Package Option Addendum at the end of this document, or see the TI website at www.ti.com.

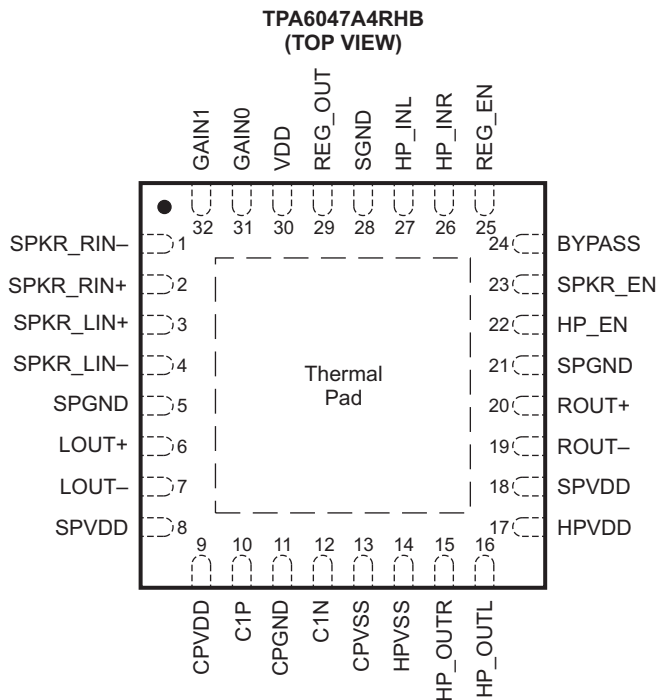
TERMINAL FUNCTIONS

| TERMINAL | | I/O/P | DESCRIPTION |
|-----------|-------|-------|--|
| NAME | NO. | | |
| SPKR_RIN– | 1 | I | Right-channel negative differential audio input for speaker amplifier |
| SPKR_RIN+ | 2 | I | Right-channel positive differential audio input for speaker amplifier |
| SPKR_LIN+ | 3 | I | Left-channel positive differential audio input for speaker amplifier |
| SPKR_LIN– | 4 | I | Left-channel negative differential audio input for speaker amplifier |
| SPGND | 5, 21 | P | Speaker power ground |
| LOU+ | 6 | O | Left-channel positive audio output |
| LOU– | 7 | O | Left-channel negative audio output |
| SPVDD | 8, 18 | P | Supply voltage terminal for speaker amplifier |
| CPVDD | 9 | P | Charge pump positive supply, connect to HPVDD via star connection |
| C1P | 10 | I/O | Charge pump flying capacitor positive terminal |
| CPGND | 11 | P | Charge pump ground |
| C1N | 12 | I/O | Charge pump flying capacitor negative terminal |
| CPVSS | 13 | P | Charge pump output (negative supply for headphone amplifier), connect to HPVSS |
| HPVSS | 14 | P | Headphone amplifier negative supply, connect to CPVSS |
| HP_OUTR | 15 | O | Right-channel capacitor-free headphone output |
| HP_OUTL | 16 | O | Left-channel capacitor-free headphone output |
| HPVDD | 17 | P | Headphone amplifier supply voltage, connect to CPVDD |
| ROUT– | 19 | O | Right-channel negative audio output |

TERMINAL FUNCTIONS (continued)

| TERMINAL | | I/O/P | DESCRIPTION |
|-------------|---------|-------|--|
| NAME | NO. | | |
| ROUT+ | 20 | O | Right-channel positive audio output |
| HP_EN | 22 | I | Headphone channel enable logic input; active high enable. HIGH=ENABLE. |
| SPKR_EN | 23 | I | Speaker channel enable logic input; active high enable. HIGH=ENABLE. |
| BYPASS | 24 | P | Common-mode bias voltage for speaker preamplifiers |
| REG_EN | 25 | I | Enable pin (Active HIGH) for turning on/off LDO. HIGH=ENABLE |
| HP_INR | 26 | I | Headphone right-channel audio input |
| HP_INL | 27 | I | Headphone left-channel audio input |
| SGND | 28 | P | Signal ground, connect to CPGND and SPGND |
| REG_OUT | 29 | O | Regulated 4.75-V output |
| VDD | 30 | P | Positive power supply |
| GAIN0 | 31 | I | Bit 0, MSB, of gain select bits |
| GAIN1 | 32 | I | Bit 1, LSB, of gain select bits |
| Thermal Pad | Die Pad | P | Solder the thermal pad on the bottom of the QFN package to the GND plane of the PCB. It is required for mechanical stability and will enhance thermal performance. |

ABSOLUTE MAXIMUM RATINGS

over operating free-air temperature range (unless otherwise noted)⁽¹⁾

| | | VALUE | UNIT |
|---|---|------------------------------|------|
| Supply voltage | HPVDD, VDD, SPVDD, CPVDD | –0.3 to 6 | V |
| V _I Input voltage | SPKR_LIN+, SPKR_LIN-, SPKR_RIN+, SPKR_RIN-, HP_EN, GAIN0, GAIN1, SPK_EN, REG_EN | –0.3 to 6.3 | V |
| | HP_INL, HP_INR HP Enabled | –3.5 to 3.5 | |
| | HP_INL, HP_INR HP not Enabled | –0.3 to 3.5 | |
| Continuous total power dissipation | | See Dissipation Rating Table | |
| T _A Operating free-air temperature range | | –40 to 85 | °C |
| T _J Operating junction temperature range | | –40 to 150 | °C |
| T _{stg} Storage temperature range | | –65 to 150 | °C |
| Electrostatic discharge | HBM for HP_OUTL and HP_OUTR | 8 | kV |
| Electrostatic discharge, all other pins | CDM | 500 | V |
| | HBM | 2 | kV |

(1) Stresses beyond those listed under *absolute maximum ratings* may cause permanent damage to the device. These are stress ratings only, and functional operations of the device at these or any other conditions beyond those indicated under *recommended operating conditions* is not implied. Exposure to absolute-maximum-rated conditions for extended periods may affect device reliability.

DISSIPATION RATINGS

| PACKAGE ⁽¹⁾ | T _A ≤ 25°C | DERATING FACTOR | T _A = 70°C | T _A = 85°C |
|------------------------|-----------------------|-----------------|-----------------------|-----------------------|
| RHB | 5.06 W | 40 mW/°C | 4.04 W | 3.23 W |

(1) The PowerPAD™ must be soldered to a thermal land on the printed-circuit board. Refer to the Texas Instruments document, PowerPAD™ Thermally Enhanced Package application report (literature number SLMA002) for more information regarding the PowerPAD™ package.

RECOMMENDED OPERATING CONDITIONS

| | | MIN | MAX | UNIT |
|--|--------------------------------------|-----|-----|------|
| Supply voltage | VDD, SPVDD | 4.5 | 5.5 | V |
| Supply voltage | HPVDD, CPVDD | 3 | 5.5 | V |
| V _{IH} High-level input voltage | SPKR_EN, HP_EN, GAIN0, GAIN1, REG_EN | 2 | | V |

RECOMMENDED OPERATING CONDITIONS (continued)

| | | | MIN | MAX | UNIT |
|-----------------|--------------------------------|--------------------------------------|-----|-----|------|
| V _{IL} | Low-level input voltage | SPKR_EN, HP_EN, GAIN0, GAIN1, REG_EN | | 0.8 | V |
| T _A | Operating free-air temperature | | -40 | 85 | °C |

GENERAL DC ELECTRICAL CHARACTERISTICS

 T_A = 25°C, VDD = SPVDD = HPVDD = CPVDD = 5 V (unless otherwise noted)

| PARAMETER | TEST CONDITIONS | MIN | TYP | MAX | UNIT |
|--------------------------|--|-----|------|-----|------|
| I _{IH} | High-level input current SPKR_EN, HP_EN, GAIN0, GAIN1, REG_EN = VDD | | 0.02 | 1 | μA |
| I _{IL} | Low-level input current SPKR_EN, HP_EN, GAIN0, GAIN1, REG_EN = 0 V | | 0.02 | 1 | μA |
| I _{DD(Speaker)} | Supply current, speaker amplifier ONLY enabled SPKR_EN = 2 V, HP_EN = REG_EN = 0 V | | 5 | 12 | mA |
| I _{DD(HP)} | Supply current, headphone amplifier ONLY enabled SPKR_EN = REG_EN = 0 V, HP_EN = 2 V | | 7.5 | 14 | mA |
| I _{DD(REG)} | Supply current, regulator ONLY enabled SPKR_EN = HP_EN = 0 V, REG_EN = 2 V | | 0.65 | 1 | mA |
| I _{DD(SD)} | Supply current, shutdown mode SPKR_EN = HP_EN = REG_EN = 0 V | | 2.5 | 5 | μA |

SPEAKER AMPLIFIER DC CHARACTERISTICS

 T_A = 25°C, VDD = SPVDD = 5 V, R_L = 4 Ω, Gain = 10 dB (unless otherwise noted)

| PARAMETER | TEST CONDITIONS | MIN | TYP | MAX | UNIT |
|-----------------|--|-----|-----|-----|------|
| V _{OO} | Output offset voltage (measured differentially) Inputs AC-coupled to GND, Gain = 10 dB | | 0.5 | 10 | mV |
| PSRR | Power supply rejection ratio VDD = SPVDD = 4.5 V to 5.5 V | -55 | -65 | | dB |

SPEAKER AMPLIFIER AC CHARACTERISTICS

 T_A = 25°C, VDD = SPVDD = 5 V, R_L = 4 Ω, Gain = 10 dB (unless otherwise noted)

| PARAMETER | TEST CONDITIONS | MIN | TYP | MAX | UNIT |
|------------------------------------|---|-----|------|-----|-------------------|
| P _O | Output power THD+N = 1%, f = 1 kHz, R _L = 8 Ω | | | | W |
| | | | | | |
| | | | | | |
| | | | | | |
| THD+N | Total harmonic distortion plus noise P _O = 1 W, R _L = 8 Ω, f = 20 Hz to 20 kHz | | | | |
| | | | | | |
| kSVR | Supply ripple rejection ratio f = 1 kHz, CBYPASS = 0.47 μF, R _L = 8 Ω V _{RIPPLE} = 200 mV _{PP} | | -53 | | dB |
| SNR | Signal-to-noise ratio Maximum output at THD+N < 1%, f = 1 kHz, Gain = 10 dB | | 99 | | dB |
| Crosstalk (Left-Right; Right-Left) | f = 1 kHz, P _O = 1 W, Gain = 10 dB | | | | dB |
| | | | | | |
| V _n | Noise output voltage CBYPASS = 0.47 μF, f = 20 Hz to 20 kHz, Gain = 10 dB, No weighting | | 30 | | μV _{rms} |
| Z _I | Input Impedance Gain = 21.6 dB | 15 | 20 | | kΩ |
| G | Gain GAIN0, GAIN1 = 0.8 V | | | | dB |
| | | | | | |
| | | | | | |
| | | | | | |
| Gain Matching | Channel-to Channel | | 0.01 | | dB |
| Start-up time from shutdown | CBYPASS = 0.47 μF | | 25 | | ms |

HEADPHONE AMPLIFIER DC ELECTRICAL CHARACTERISTICS

$T_A = 25^\circ\text{C}$, $\text{HPVDD} = \text{CPVDD} = \text{VDD} = 5\text{ V}$, $R_L = 16\ \Omega$ (unless otherwise noted)

| PARAMETER | | TEST CONDITIONS | MIN | TYP | MAX | UNIT |
|------------|------------------------------|------------------------|-----|------|-----|------|
| $ V_{OS} $ | Output offset voltage | Inputs grounded | | 1.5 | | mV |
| PSRR | Power supply rejection ratio | HPVDD = 4.5 V to 5.5 V | -75 | -100 | | dB |

HEADPHONE AMPLIFIER AC CHARACTERISTICS

$T_A = 25^\circ\text{C}$, $\text{HPVDD} = 5\text{ V}$, $R_L = 16\ \Omega$ (unless otherwise noted)

| PARAMETER | | TEST CONDITIONS | MIN | TYP | MAX | UNIT |
|-----------|--------------------------------------|--|-------|------|-------|------------------|
| P_O | Output power (outputs in phase) | THD+N = 10%, $R_L = 16\ \Omega$, $f = 1\text{ kHz}$ | | 100 | | mW |
| | | THD+N = 10%, $R_L = 32\ \Omega$, $f = 1\text{ kHz}$ | | 50 | | |
| THD+N | Total harmonic distortion plus noise | $P_O = 80\text{ mW}$, $f = 20\text{ Hz to }20\text{ kHz}$, $R_L = 16\ \Omega$ | | 0.1 | | % |
| | | $P_O = 40\text{ mW}$, $f = 20\text{ Hz to }20\text{ kHz}$, $R_L = 32\ \Omega$ | | 0.1 | | |
| | Dynamic Range with Signal Present | A-Weighted, $f = 20\text{ Hz to }20\text{ kHz}$ | | -89 | | dB FS |
| kSVR | Supply ripple rejection | $f = 1\text{ kHz}$, 200-mV _{PP} ripple | | -60 | | dB |
| | Crosstalk | $P_O = 2.8\text{ mW}$, $f = 20\text{ Hz to }20\text{ kHz}$ | | -90 | | dB |
| V_n | Noise output voltage | $f = 20\text{ Hz to }20\text{ kHz}$, No weighting | | 20 | | μVrms |
| Z_I | Input Impedance | | 15 | 20 | | k Ω |
| Gain | Closed-loop voltage gain | $R_L = 16\ \Omega$ | -1.45 | -1.5 | -1.55 | V/V |
| | Start-up time from shutdown | | | 8 | | ms |

LDO CHARACTERISTICS

$T_A = 25^\circ\text{C}$, $\text{VDD} = 5\text{ V}$ (unless otherwise noted)

| PARAMETER | | TEST CONDITIONS | MIN | TYP | MAX | UNIT |
|-----------|-------------------------------|--|------|------|------|--------|
| V_I | Input voltage | V_{DD} | 4.5 | | 5.5 | V |
| I_O | Continuous output current | | | 120 | | mA |
| V_O | Output voltage | $0 < I_O < 120\text{ mA}$; $4.9\text{ V} < V_{in} < 5.5\text{ V}$ | 4.65 | 4.75 | 4.85 | V |
| | Line regulation | $I_L = 5\text{ mA}$; $4.9\text{ V} < V_{in} < 5.5\text{ V}$ | | 1.8 | 10 | mV |
| | Load regulation | $I_L = 0 - 120\text{ mA}$, $V_{in} = 5\text{ V}$ | | 0.13 | | mV/ mA |
| | Power supply ripple rejection | $V_{DD} = 4.9\text{ V}$, $I_L = 10\text{ mA}$ | | -46 | | dB |
| | | $f = 100\text{ Hz}$ | | | | |

TYPICAL CHARACTERISTICS

Default graph conditions: $V_{CC} = 5\text{ V}$, $\text{Freq} = 1\text{ kHz}$, AES17 Filter.

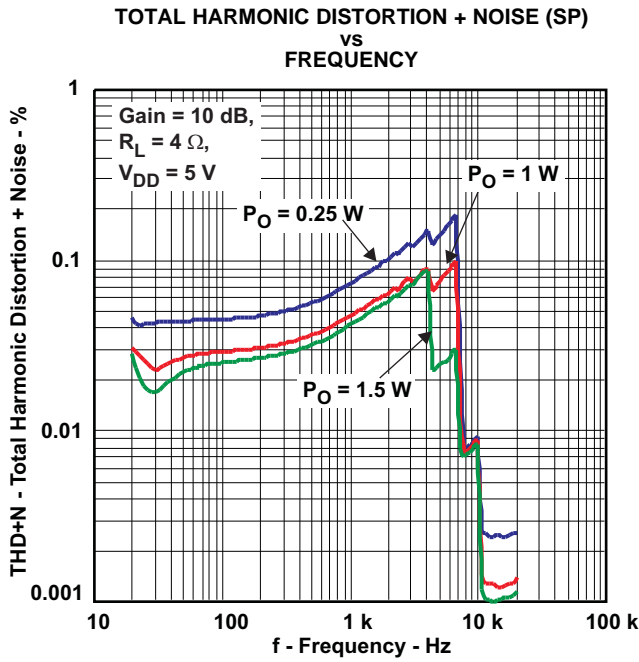

Figure 1.

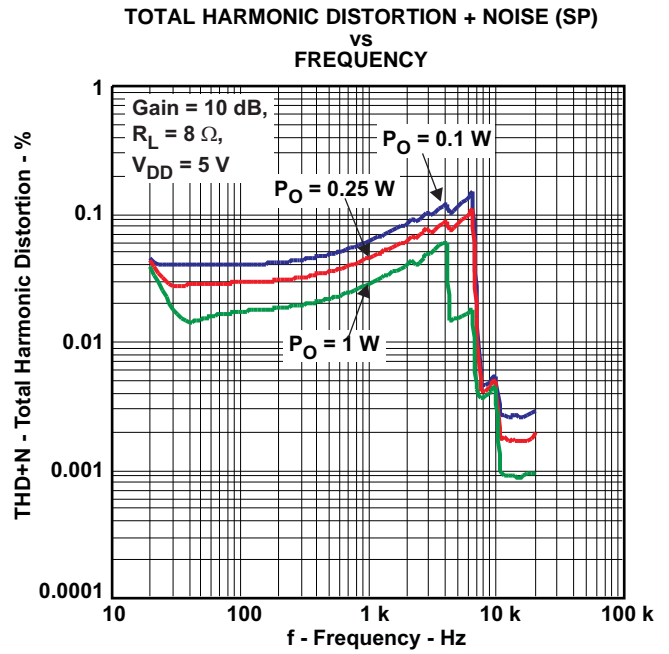

Figure 2.

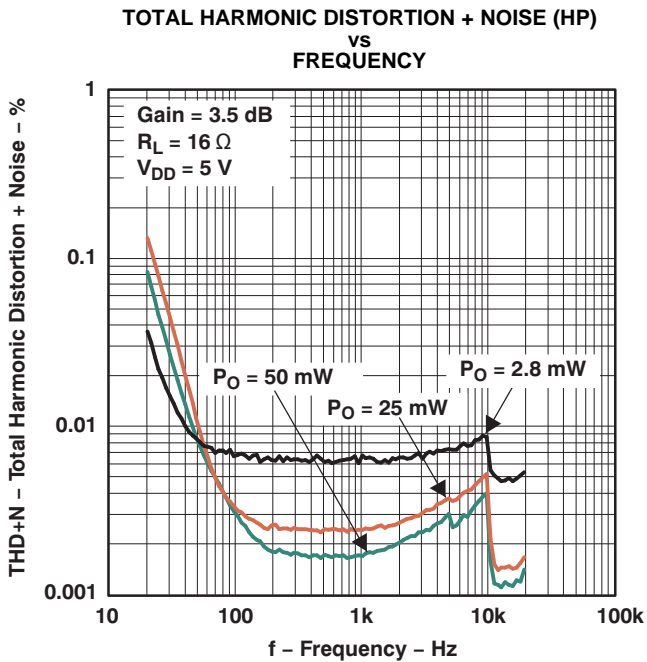

Figure 3.

G003

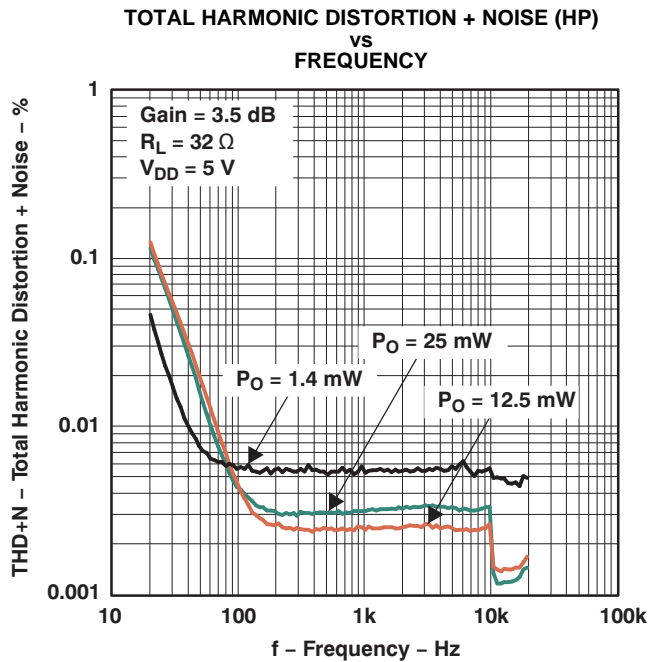

Figure 4.

G004

TYPICAL CHARACTERISTICS (continued)

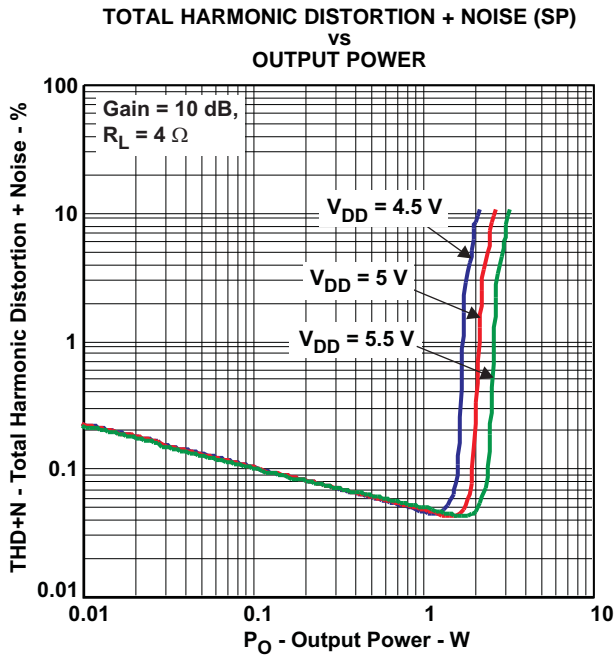

Figure 5.

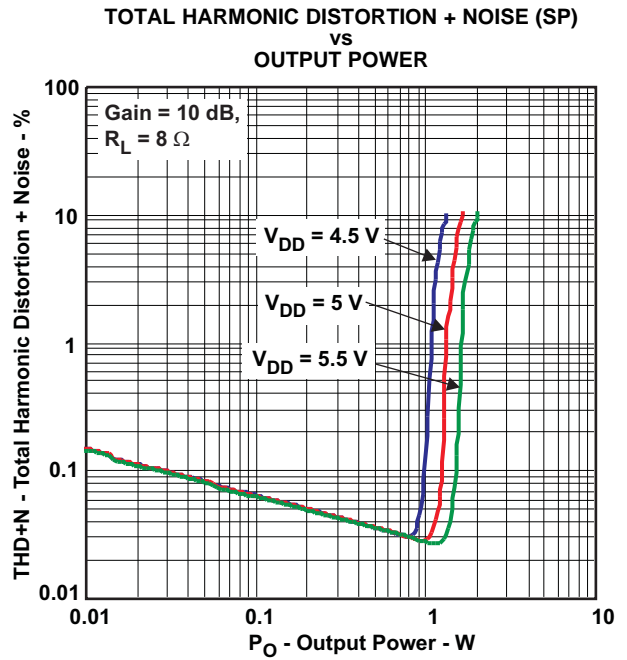

Figure 6.

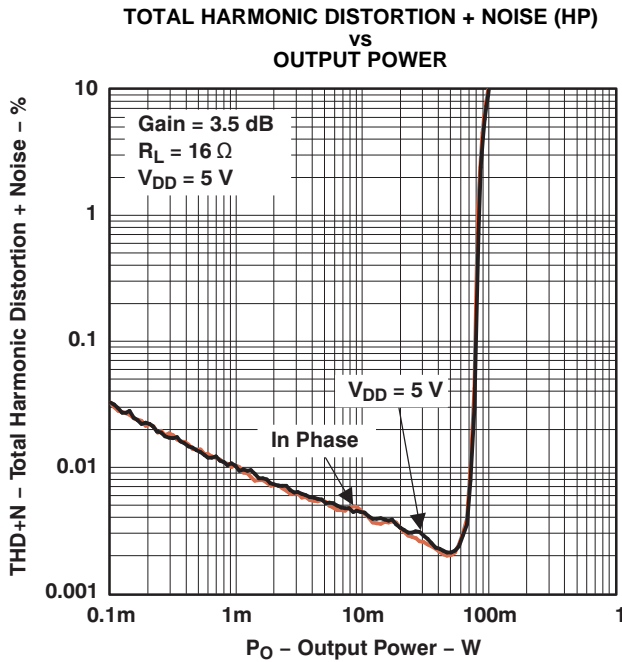

Figure 7.

G007

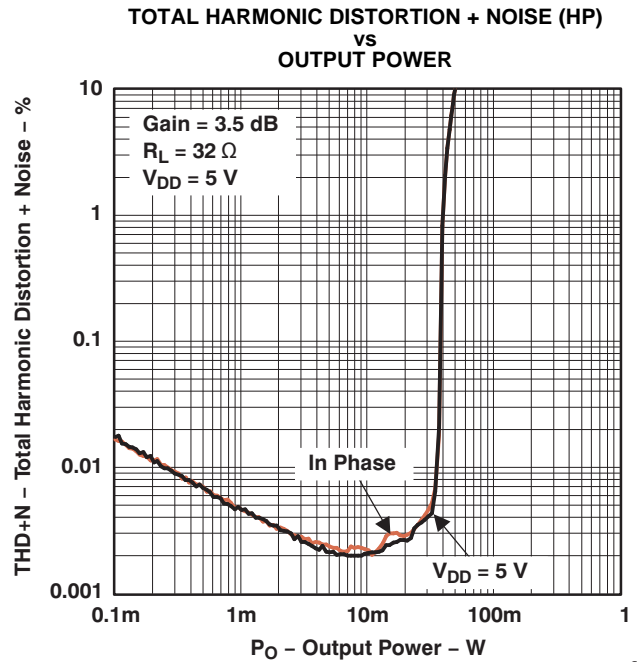

Figure 8.

G008

TYPICAL CHARACTERISTICS (continued)

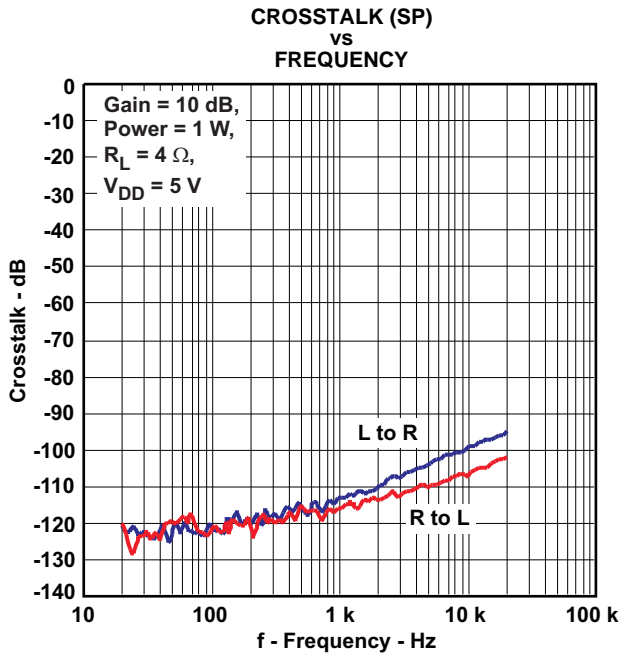

Figure 9.

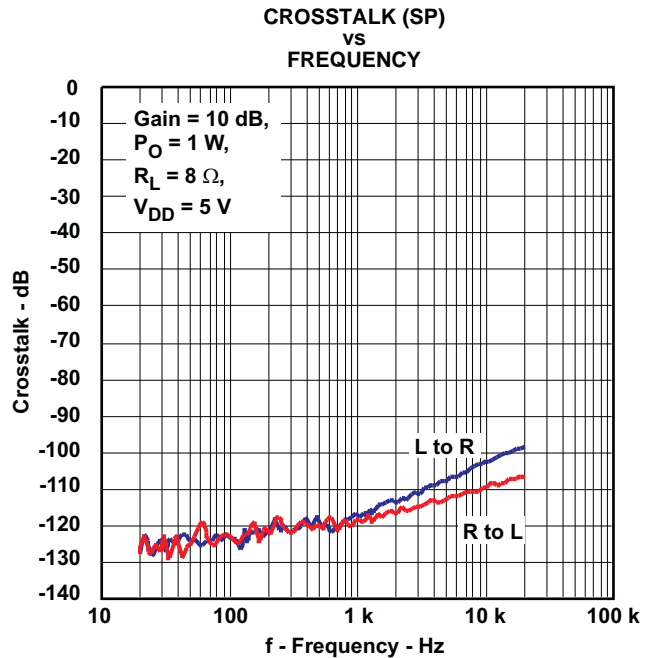

Figure 10.

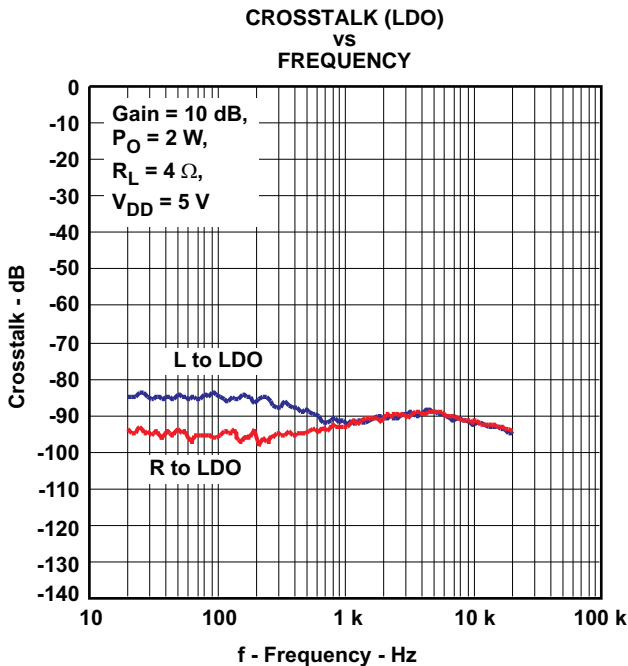

Figure 11.

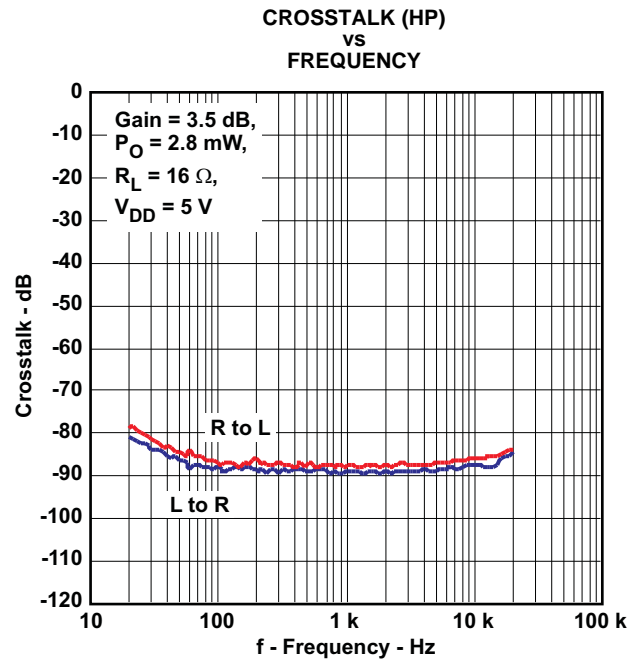

Figure 12.

TYPICAL CHARACTERISTICS (continued)

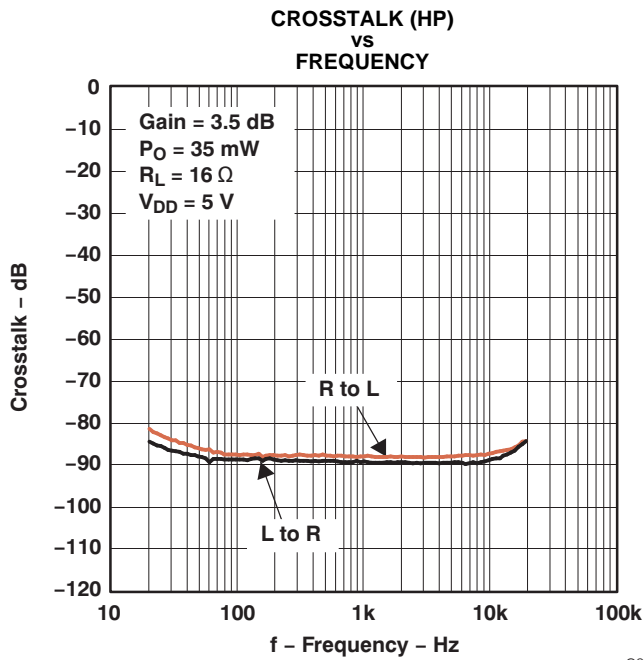

Figure 13.

G012

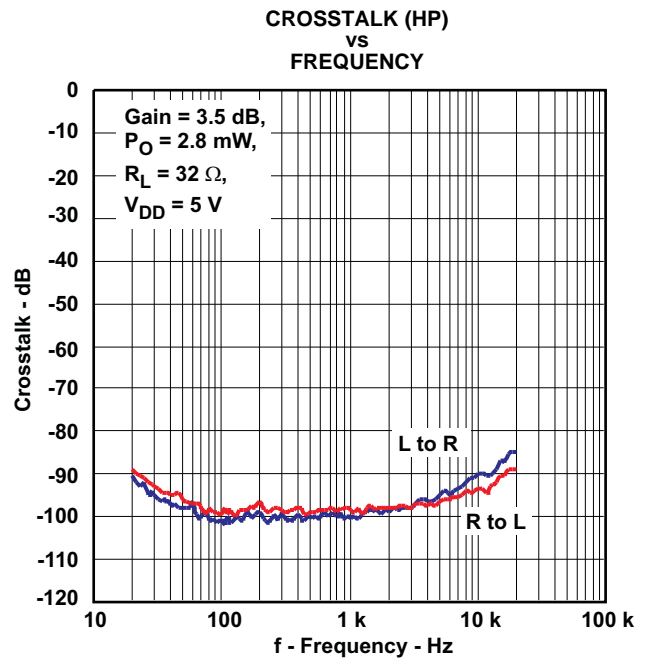

Figure 14.

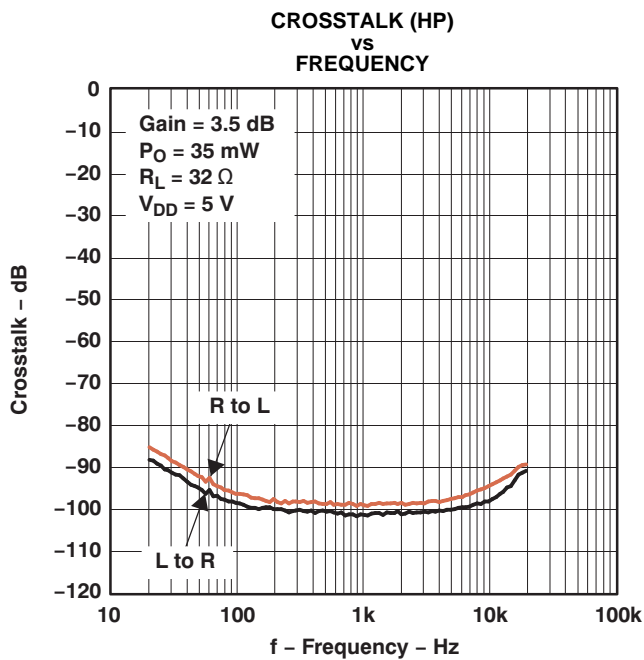

Figure 15.

G013

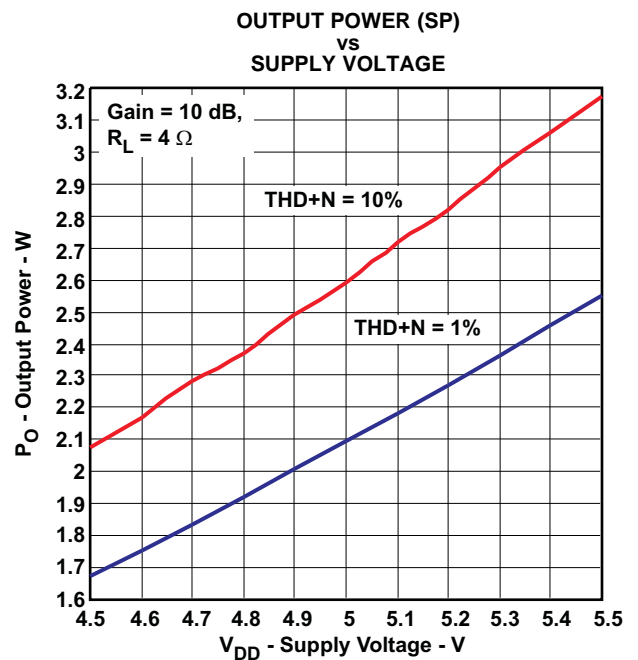

Figure 16.

TYPICAL CHARACTERISTICS (continued)

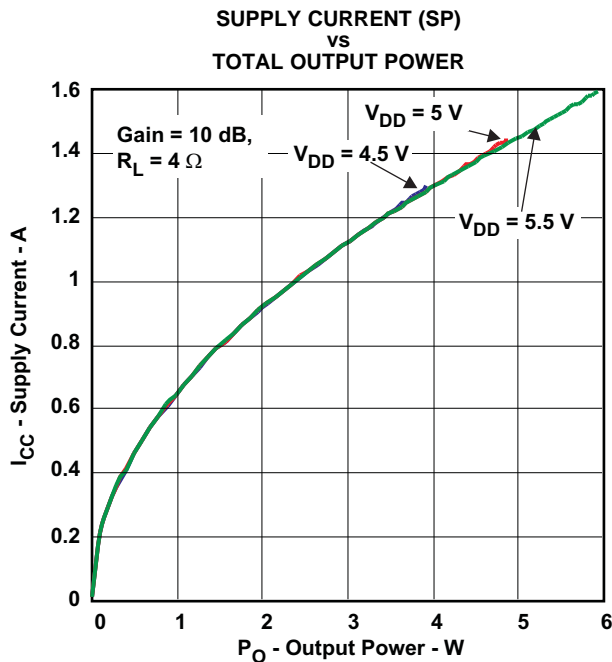

Figure 17.

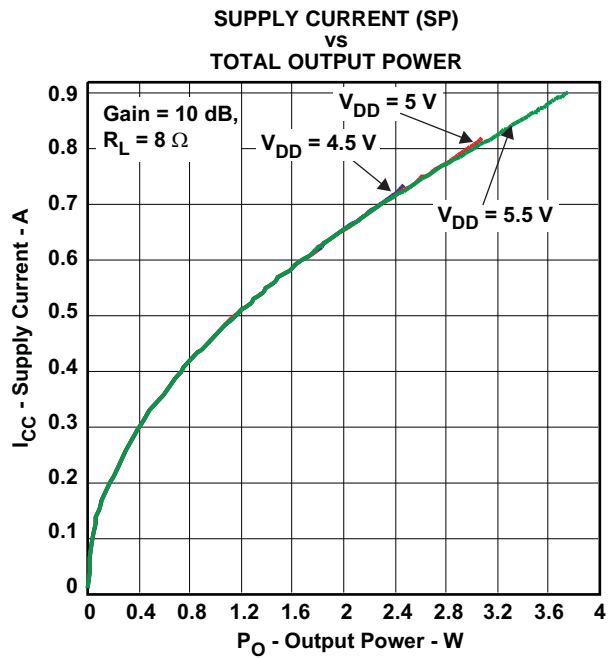

Figure 18.

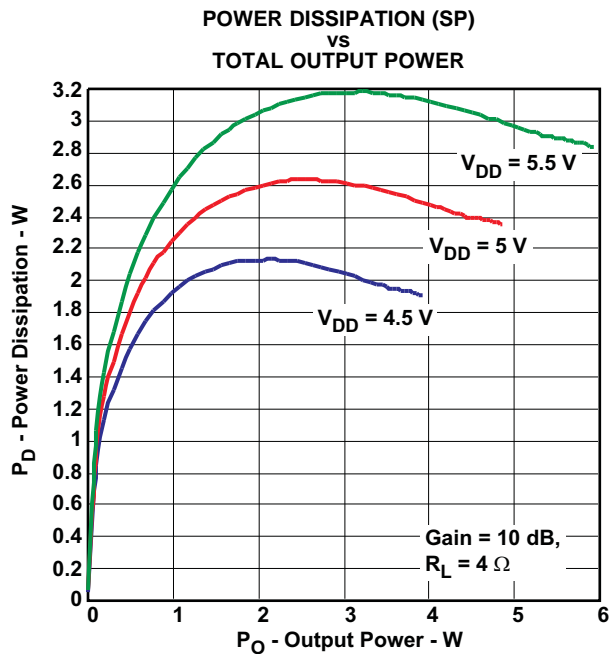

Figure 19.

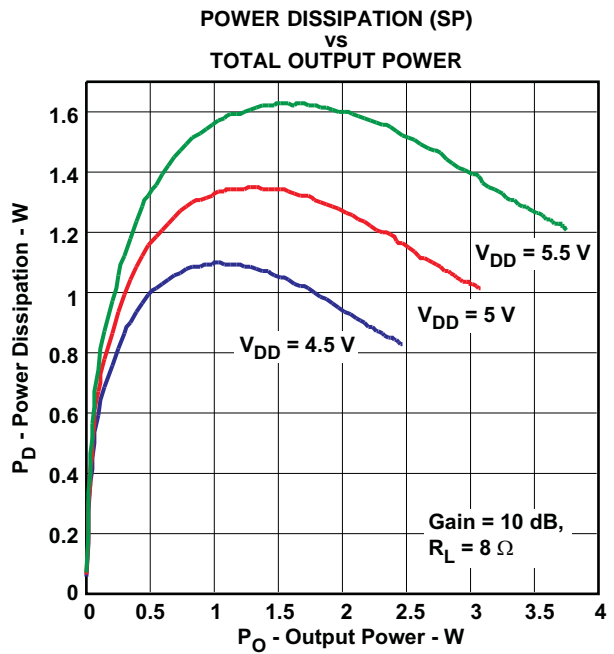

Figure 20.

TYPICAL CHARACTERISTICS (continued)

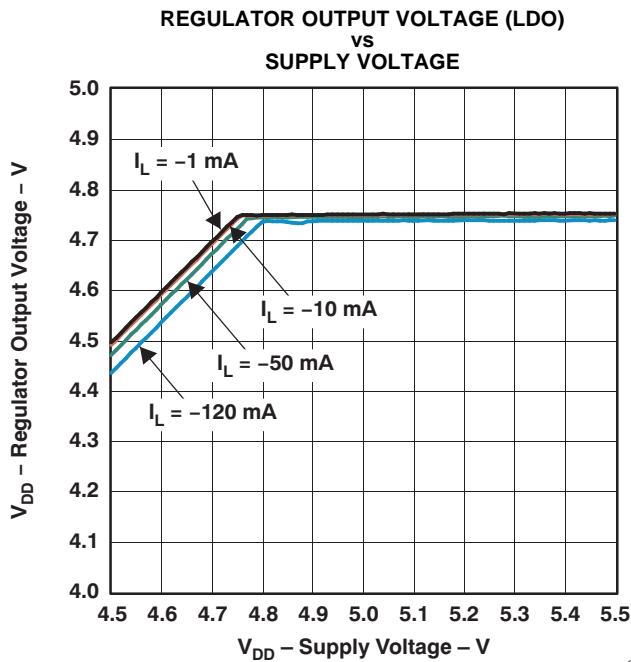

Figure 21.

G021

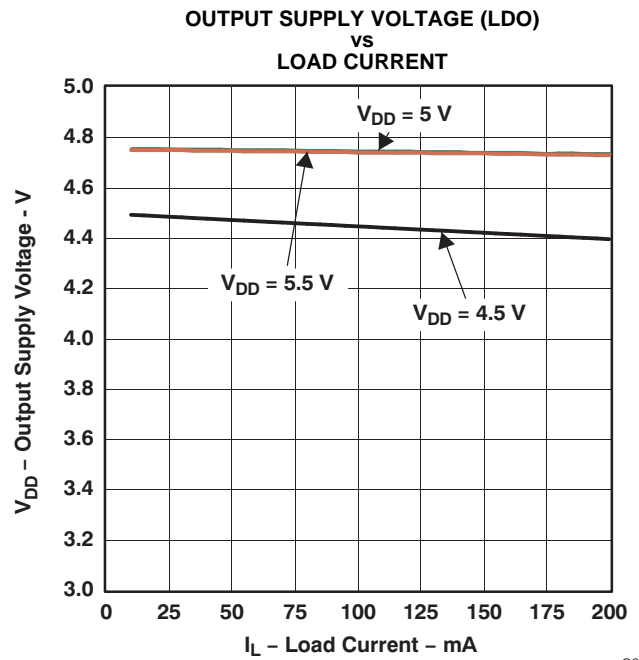

Figure 22.

G022

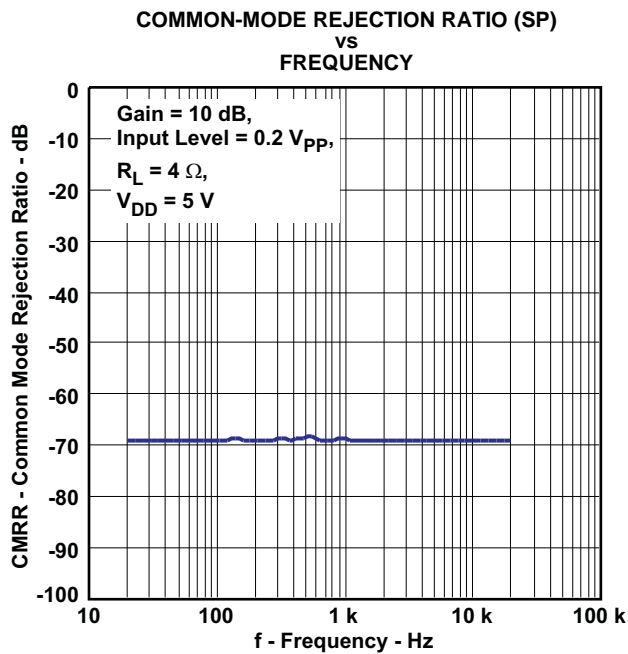

Figure 23.

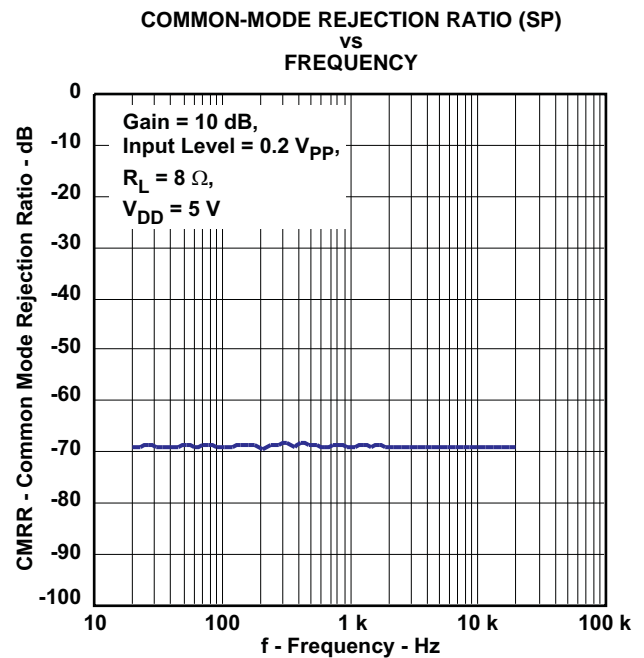

Figure 24.

TYPICAL CHARACTERISTICS (continued)

SUPPLY RIPPLE REJECTION RATIO (LDO)
vs
FREQUENCY

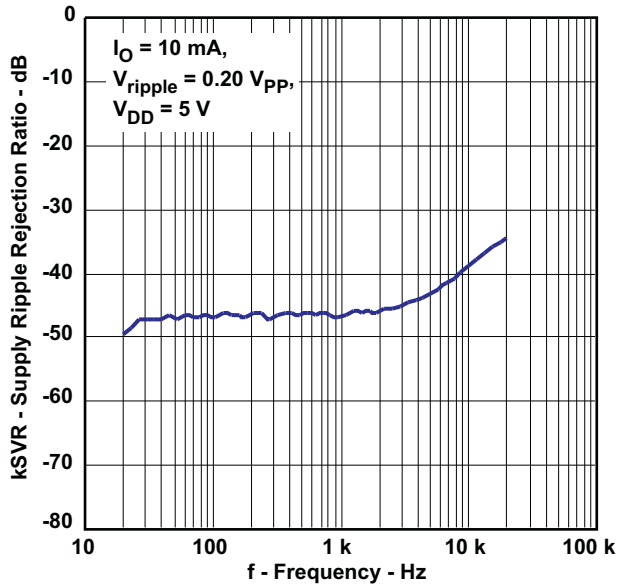

Figure 25.

SUPPLY RIPPLE REJECTION RATIO (SP)
vs
FREQUENCY

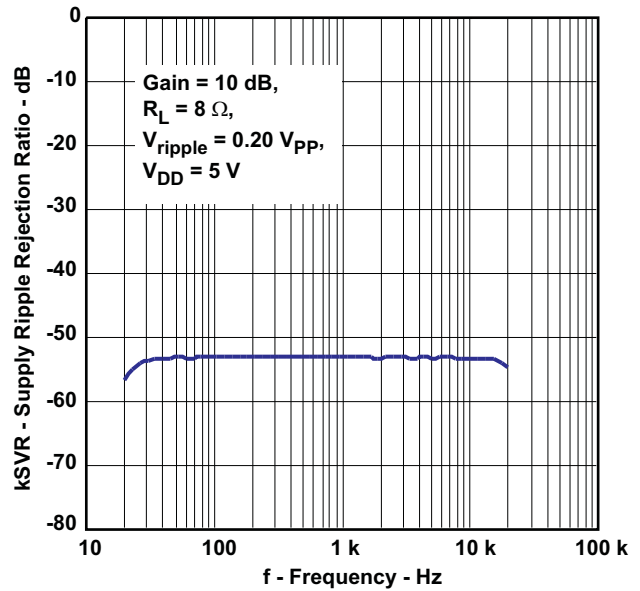

Figure 26.

SUPPLY RIPPLE REJECTION RATIO (HP)
vs
FREQUENCY

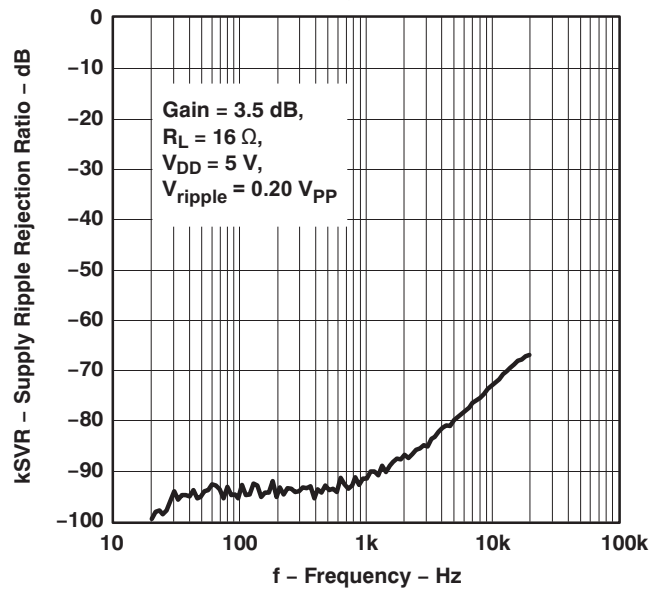

Figure 27.

TYPICAL CHARACTERISTICS (continued)

SPEAKER SHUTDOWN - 8 Ω - 10 dB

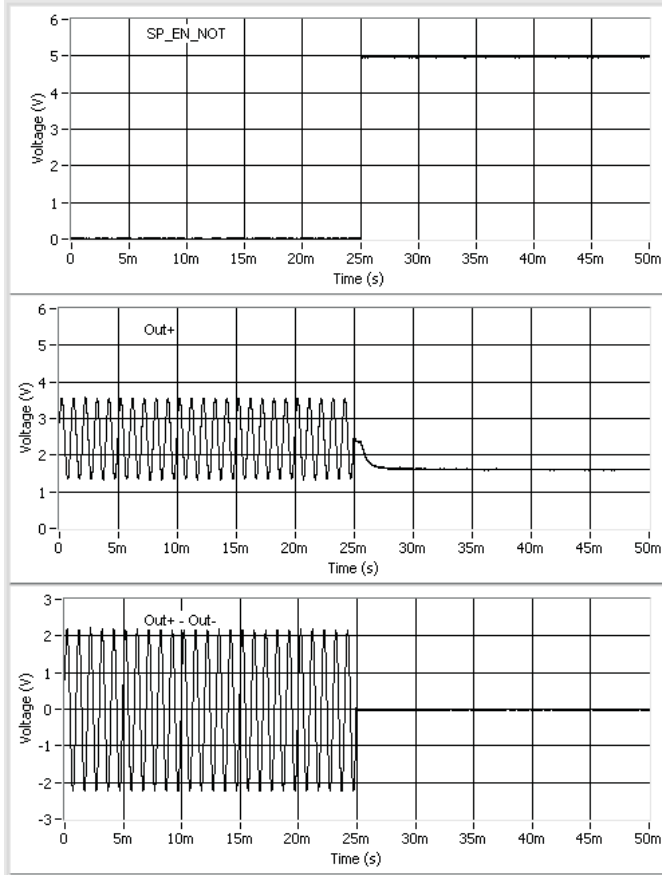

Figure 28.

SPEAKER STARTUP - 8 Ω - 10 dB

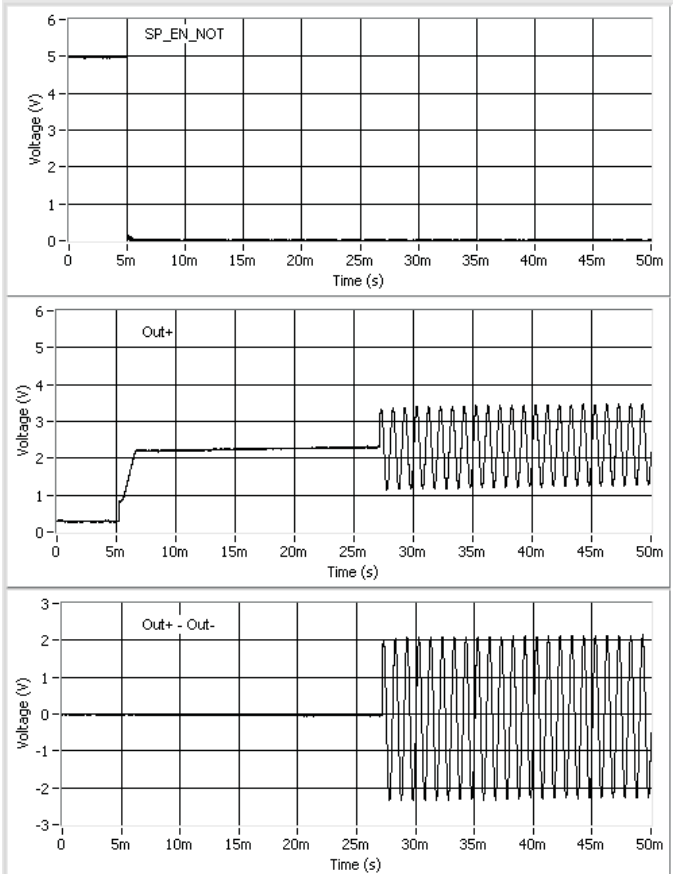

Figure 29.

HP SHUTDOWN - 32 Ω

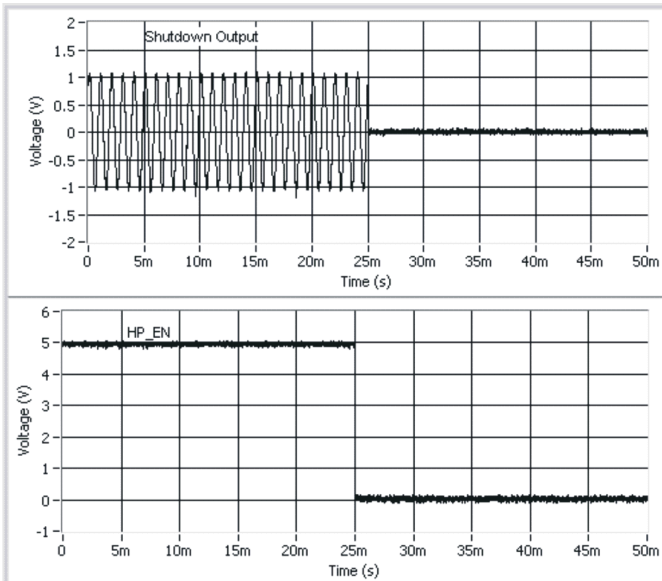

Figure 30.

HP STARTUP - 32 Ω

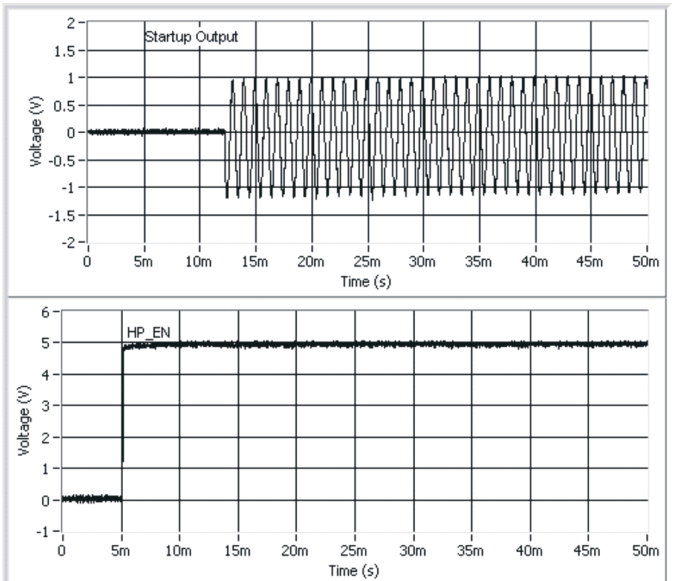

Figure 31.

APPLICATION INFORMATION

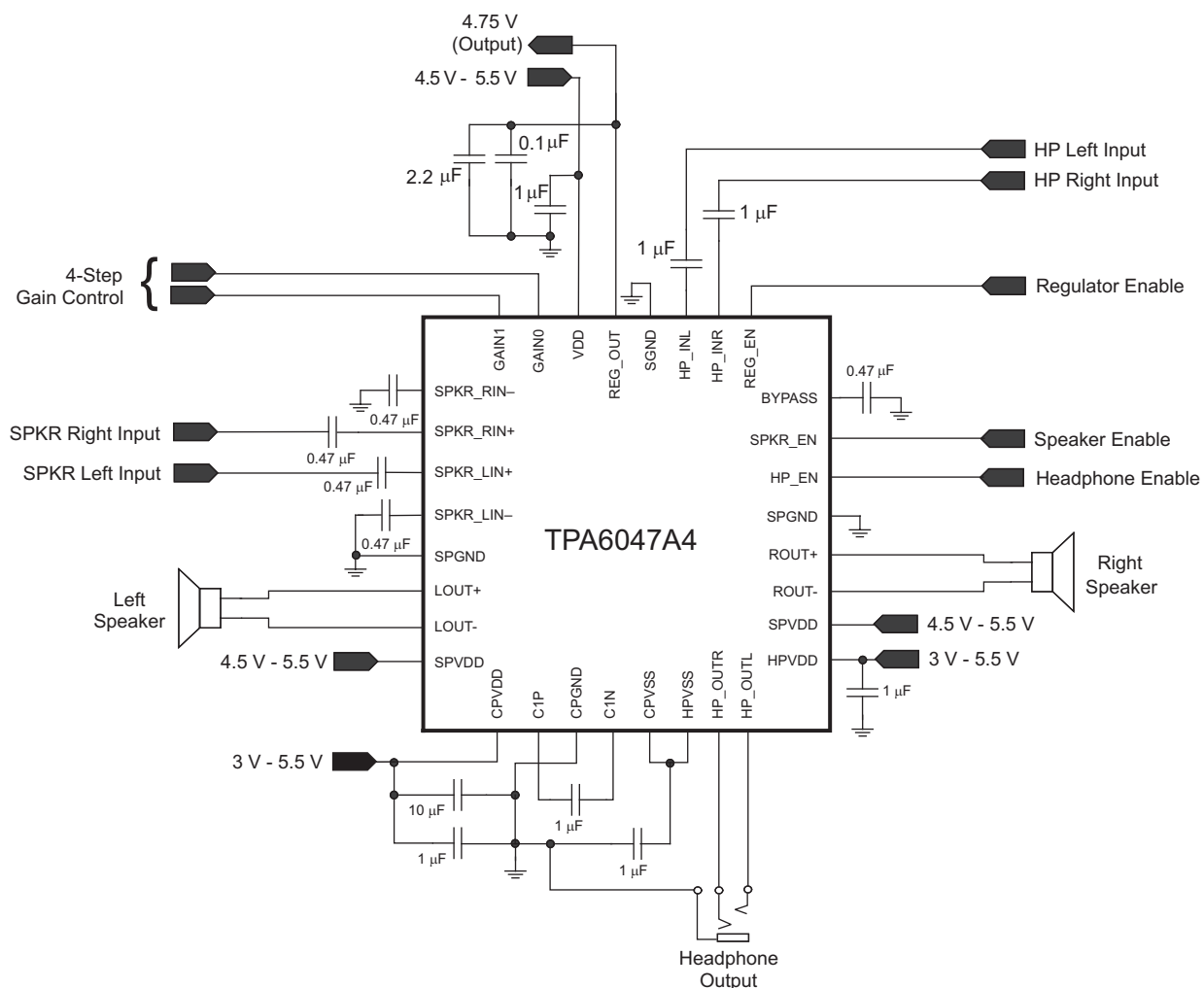

Figure 32. Single-Ended Input Application Circuit

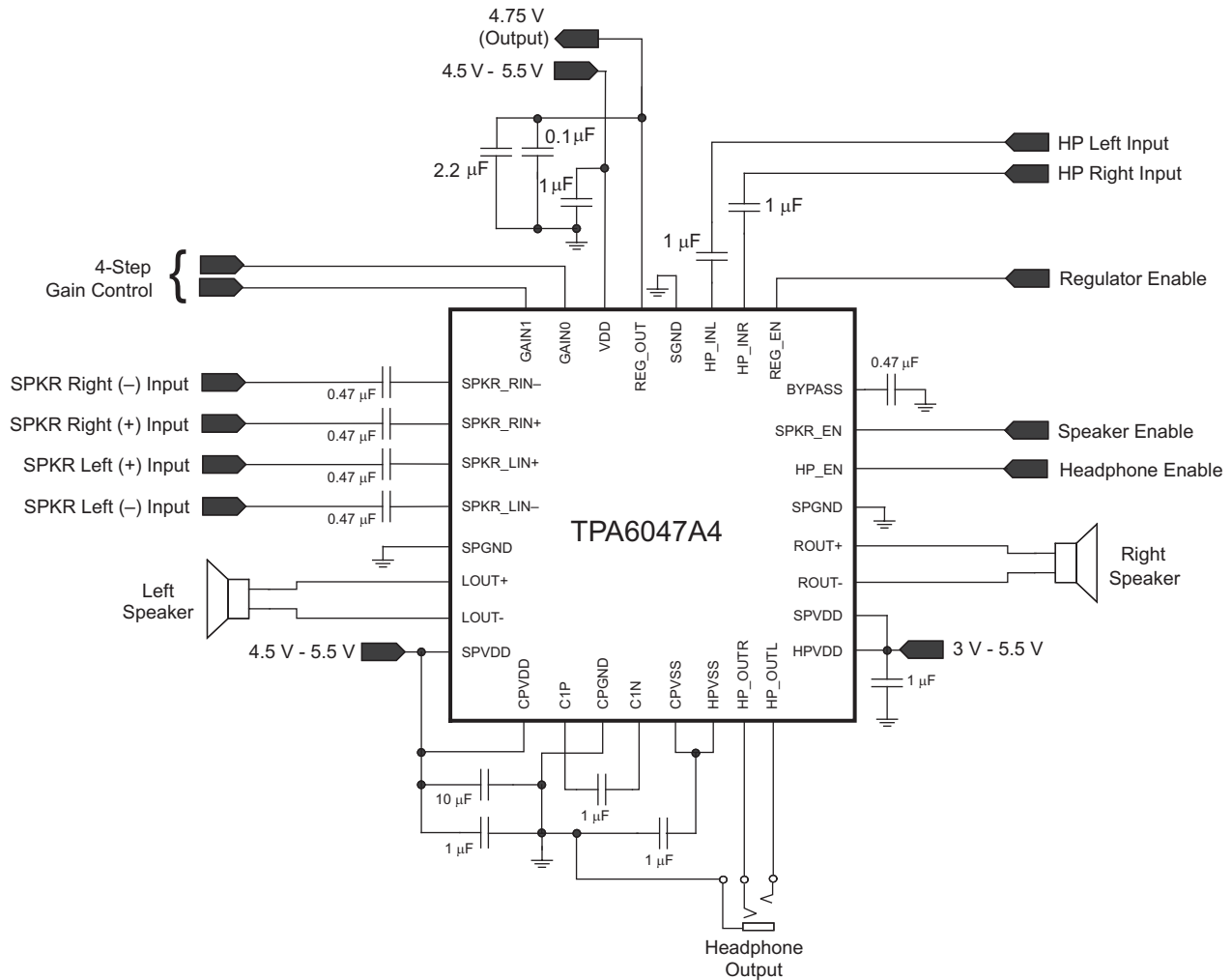

Figure 33. Differential Input Application Circuit

Power Enable Modes

The TPA6047A4 allows the disabling of any or all of the main circuit blocks when not in use in order to reduce operating power to an absolute minimum. The SPKR_EN control can be used to disable the speaker amplifier while the HP_EN can be used separately to turn off the headphone amplifier. The LDO also has an independent power control, REG_EN. With all circuit blocks disabled, the supply current in shutdown mode is only 5 µA. See the General DC Electrical Characteristics for operating currents with each circuit block operating independently.

Speaker Amplifier Description

The speaker amplifier is capable of driving 2.1 W/ch of continuous RMS power into a 4-Ω load at 5 V. TPA6047A4 has 4-step gain control from 10 dB to 21.6 dB.

Fully Differential Amplifier

The TPA6047A4 speaker amplifier is a fully differential amplifier with differential inputs and outputs. The fully differential architecture consists of a differential amplifier and a common mode amplifier. The differential amplifier ensures that the amplifier outputs a differential voltage that is equal to the differential input times the gain. The common-mode voltage at the output is biased around $V_{DD}/2$ regardless of the common-mode voltage at the input.

One of the primary advantages of the fully differential amplifier is improved RF immunity. GSM handsets save power by turning on and off the RF transmitter at a rate of 217 Hz. The transmitted signal is picked up on input and output traces. The fully differential amplifier cancels the signal and others of this type much better than typical audio amplifiers.

Gain Setting via GAIN0 and GAIN1 Inputs

The gain of the TPA6047A4 is set by two terminals, GAIN0 and GAIN1. The gains listed in Table 1 are realized by changing the taps on the input resistors and feedback resistors inside the amplifier. This causes the input impedance (Z_i) to vary as a function of the gain setting.

Table 1. Gain Setting

| GAIN1 | GAIN0 | AMPLIFIER GAIN (dB) | INPUT IMPEDANCE (kΩ) |
|-------|-------|---------------------|----------------------|
| | | TYPICAL | TYPICAL |
| 0 | 0 | 10 | 78 |
| 0 | 1 | 12 | 65 |
| 1 | 0 | 15.6 | 46 |
| 1 | 1 | 21.6 | 20 |

Input Capacitor, C_i

The input capacitor allows the amplifier to bias the input signal to the proper dc level for proper operation. In this case, the input capacitor, C_i , and the input impedance of the amplifier, R_i , form a high-pass filter with the corner frequency determined in Equation 1. Figure 34 shows how the input capacitor and the input resistor within the amplifier interact.

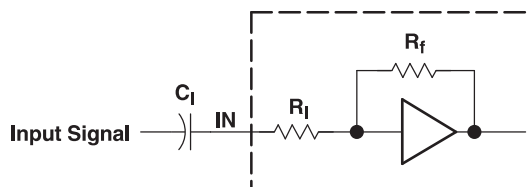
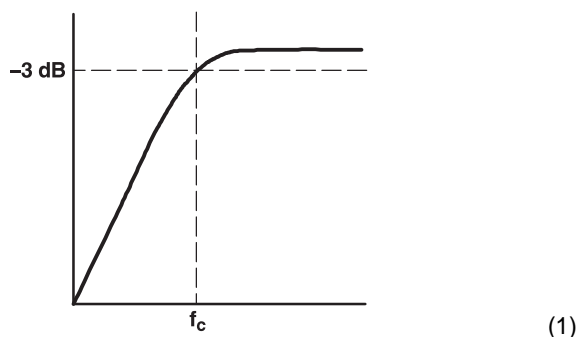

Figure 34. Input Resistor and Input Capacitor

$$f_{c(\text{highpass})} = \frac{1}{2\pi R_i C_i} \quad (1)$$



The value of C_i is important to consider as it directly affects the low-frequency, or bass, performance of the circuit. Furthermore, the input impedance changes with a change in volume. The higher the volume, the lower the input impedance is. To determine the appropriate capacitor value, reconfigure Equation 1 into Equation 2. The value of the input resistor, R_i , can be determined from Equation 2.

$$C_i = \frac{1}{2\pi R_i f_c} \quad (2)$$

Low-leakage tantalum or ceramic capacitors are recommended. When polarized capacitors are used, the positive side of the capacitor should face the amplifier input in most applications as the dc level there is held at $V_{CC}/2$, which is likely higher than the source dc level. Note that it is important to confirm the capacitor polarity in each specific application. Recommended capacitor values are between 0.1 μF and 1 μF .

Windows Vista™ Premium Mobile Mode Specifications

| Device Type | Requirement | Windows Premium Mobile Vista Specifications | TPA6047A4 Typical Performance |
|---|-----------------------------------|---|------------------------------------|
| Analog Speaker Line Jack ($R_L = 10\text{ k}\Omega$, $FS = 0.707\text{ V}_{rms}$) | THD+N | $\leq -65\text{ dB FS [20 Hz, 20 kHz]}$ | $-88\text{ dB FS [20 Hz, 20 kHz]}$ |
| | Dynamic Range with Signal Present | $\leq -80\text{ dB FS A-Weight}$ | $-88\text{ dB FS A-Weight}$ |
| | Line Output Crosstalk | $\leq -60\text{ dB [20 Hz, 20 kHz]}$ | $-105\text{ dB [20 Hz, 20 kHz]}$ |
| Analog Headphone Out Jack ($R_L = 32\Omega$, $FS = 0.300\text{ V}_{rms}$) | THD+N | $\leq -45\text{ dB FS [20 Hz, 20 kHz]}$ | $-85\text{ dB FS [20 Hz, 20 kHz]}$ |
| | Dynamic Range with Signal Present | $\leq -80\text{ dB FS A-Weight}$ | $-89\text{ dB FS A-Weight}$ |
| | Headphone Output Crosstalk | $\leq -60\text{ dB [20 Hz, 20 kHz]}$ | $-100\text{ dB [20 Hz, 20 kHz]}$ |

Bridge-Tied Load Versus Single-Ended Mode

Figure 35 shows a Class-AB audio power amplifier (APA) in a bridge-tied-load (BTL) configuration. The TPA6047A4 speaker amplifier consists of two Class-AB differential amplifiers per channel driving the positive and negative terminals of the load. Specifically, differential drive means that as one side of the amplifier (the positive terminal, for example) is slewing up, the other side is slewing down, and vice versa. This doubles the voltage swing across the load as opposed to a ground-referenced load, or a single-ended load. Power is proportional to the square of the voltage. Plugging $2x\text{ VO(PP)}$ into the power equation yields $4x$ the output power from the same supply rail and load impedance as would have been obtained with a ground-referenced load (see Equation 3).

$$V_{(RMS)} = \frac{V_{O(PP)}}{2\sqrt{2}}$$

$$\text{Power} = \frac{V_{(RMS)}^2}{R_L}$$

(3)

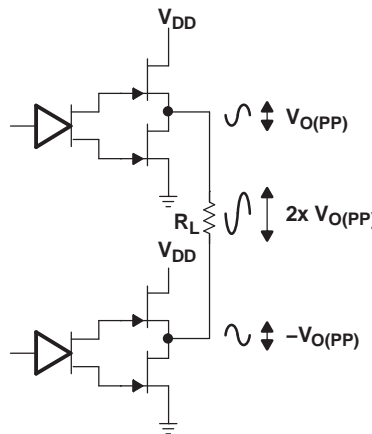

Figure 35. Differential Output Configuration

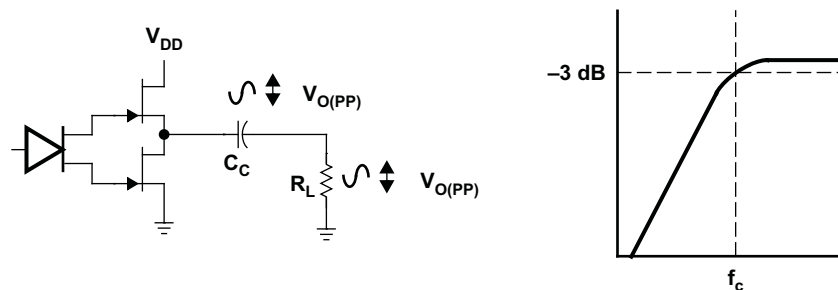

Figure 36. Single-Ended Configuration and Frequency Response

Bridge-tying the outputs in a typical computer audio, LCD TV, or multimedia LCD monitor application drastically increases output power. For example, if an amplifier in a single-ended configuration was capable of outputting a maximum of 250 mW for a given load with a supply voltage of 12 V, then that same amplifier would be able to output 1 W of power in a BTL configuration with the same supply voltage and load. In addition to the increase in output power, the BTL configuration does not suffer from the same low-frequency issues that plague the single-ended configuration. In a BTL configuration, there is no need for an output capacitor to block dc, so no unwanted filtering occurs. In addition, the BTL configuration saves money and space, as the dc-blocking capacitors needed for single-ended operation are large and expensive. For example, with an 8-Ω load in SE operation, the user needs a 1000-μF capacitor to obtain a cutoff frequency below 20 Hz. This capacitor is expensive and large.

Headphone Amplifier Description

The headphone amplifier has a fixed gain of -1.5 V/V. It uses single-ended (SE) inputs. The DirectPath™ amplifier architecture operates from a single supply but makes use of an internal charge pump to provide a negative voltage rail. Combining the user-provided positive rail and the negative rail generated by the IC, the device operates in what is effectively a split supply mode. The output voltages are now centered at zero volts with the capability to swing to the positive rail or negative rail. The DirectPath™ amplifier requires no output dc blocking capacitors and does not place any voltage on the sleeve. The block diagram and waveform of [Figure 37](#) illustrate the ground-referenced headphone architecture. This is the architecture of the TPA6047A4.

Single-supply headphone amplifiers typically require dc-blocking capacitors. The capacitors are required because most headphone amplifiers have a dc bias on the outputs pin. If the dc bias is not removed, the output signal is severely clipped, and large amounts of dc current rush through the headphones, potentially damaging them. The left-side drawing in [Figure 37](#) illustrates the conventional headphone amplifier connection to the headphone jack and output signal.

DC blocking capacitors are often large in value. The headphone speakers (typical resistive values of 16 Ω or 32 Ω) combine with the dc blocking capacitors to form a high-pass filter. [Equation 4](#) shows the relationship between the load impedance (R_L), the capacitor (C_O), and the cutoff frequency (f_c).

$$f_c = \frac{1}{2\pi R_L C_O} \quad (4)$$

C_O can be determined using [Equation 5](#), where the load impedance and the cutoff frequency are known.

$$C_O = \frac{1}{2\pi R_L f_c} \quad (5)$$

If f_c is low, the capacitor must then have a large value because the load resistance is small. Large capacitance values require large package sizes. Large package sizes consume PCB area, stand high above the PCB, increase cost of assembly, and can reduce the fidelity of the audio output signal.

Two different headphone amplifier applications are available that allow for the removal of the output dc blocking capacitors. The capacitor-less amplifier architecture is implemented in the same manner as the conventional amplifier with the exception of the headphone jack shield pin. This amplifier provides a reference voltage, which is connected to the headphone jack shield pin. This is the voltage on which the audio output signals are centered. This voltage reference is half of the amplifier power supply to allow symmetrical swing of the output voltages. Do not connect the shield to any GND reference, or large currents will result. The scenario can happen if, for example, an accessory other than a floating GND headphone is plugged into the headphone connector. See the second block diagram and waveform in [Figure 37](#).

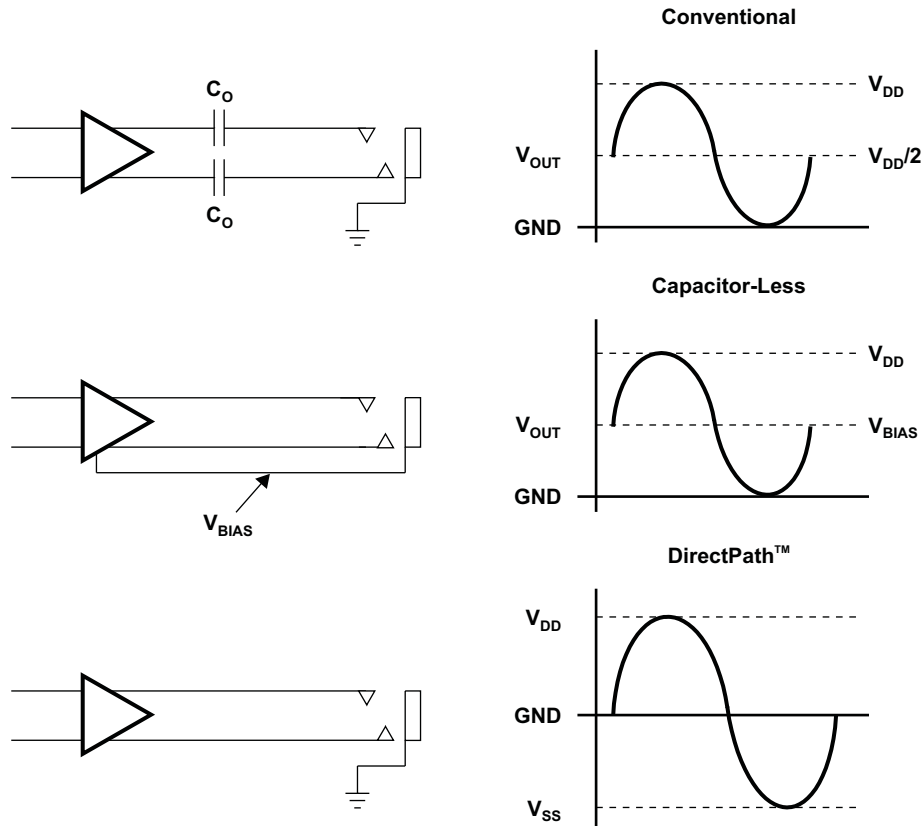

Figure 37. Amplifier Applications

Input-Blocking Capacitors

DC input-blocking capacitors block the dc portion of the audio source and allow the inputs to properly bias. Maximum performance is achieved when the inputs of the TPA6047A4 are properly biased. Performance issues such as pop are optimized with proper input capacitors.

The dc input-blocking capacitors can be removed, provided the inputs are connected differentially and within the input common-mode range of the amplifier, the audio signal does not exceed ± 3 V, and pop performance is sufficient.

C_{IN} is a theoretical capacitor used for mathematical calculations only. Its value is the series combination of the dc input-blocking capacitors, $C_{(DCINPUT-BLOCKING)}$. Use Equation 6 to determine the value of $C_{(DCINPUT-BLOCKING)}$. For example, if C_{IN} is equal to $0.22 \mu\text{F}$, then $C_{(DCINPUT-BLOCKING)}$ is equal to about $0.47 \mu\text{F}$.

$$C_{IN} = \frac{1}{2} C_{(DCINPUT-BLOCKING)} \tag{6}$$

The two $C_{(DCINPUT-BLOCKING)}$ capacitors form a high-pass filter with the input impedance of the TPA6047A4. Use Equation 6 to calculate C_{IN} , then calculate the cutoff frequency using C_{IN} and the differential input impedance of the TPA6047A4, R_{IN} , using Equation 7. Note that the differential input impedance changes with gain. See Table 1 for input impedance values. The frequency and/or capacitance can be determined when one of the two values are given.

$$f_{C_{IN}} = \frac{1}{2\pi R_{IN} C_{IN}} \quad \text{or} \quad C_{IN} = \frac{1}{2\pi f_{C_{IN}} R_{IN}} \quad (7)$$

If a high-pass filter with a –3-dB point of no more than 20 Hz is desired over all gain settings, the minimum impedance would be used in the [Equation 7](#). The minimum input impedance for TPA6047A4 is 20 kΩ. The capacitor value by [Equation 7](#) would be 0.399 μF. However, this is C_{IN}, and the desired value is for C_(DCINPUT-BLOCKING). Multiplying C_{IN} by 2 yields 0.80 μF, which is close to the standard capacitor value of 1 μF. Place 1-μF capacitors at each input terminal of the TPA6047A4 to complete the filter.

Charge Pump Flying Capacitor and CPVSS Capacitor

The charge pump flying capacitor serves to transfer charge during the generation of the negative supply voltage. The CPVSS capacitor must be at least equal to the flying capacitor in order to allow maximum charge transfer. Low ESR capacitors are an ideal selection, and a value of 1 μF is typical. Use X5R or better ceramic material.

Decoupling Capacitors

The TPA6047A4 is a DirectPath™ headphone amplifier that requires adequate power supply decoupling to ensure that the noise and total harmonic distortion (THD) are as low as possible. To filter high-frequency transients, spikes, and digital hash on the power line, use good low equivalent-series-resistance (ESR) ceramic capacitors, typically 1 μF. Find the smallest package possible, and place as close as possible to the device V_{DD} lead. Placing the decoupling capacitors close to the TPA6047A4 is important for the performance of the amplifier. Use a 10 μF or greater capacitor near the TPA6047A4 to filter lower frequency noise signals; however, the high PSRR of the TPA6047A4 makes the 10-μF capacitor unnecessary in most applications.

Midrail Bypass Capacitor, C_{BYPASS}

The midrail bypass capacitor, C_(BYPASS), has several important functions. During start-up or recovery from shutdown mode, C_{BYPASS} determines the rate at which the amplifier starts up. A 1-μF capacitor yields a start-up time of approximately 25 ms. C_{BYPASS} also reduces the noise coupled into the output signal by the power supply. This improves the power supply ripple rejection (PSRR) of the amplifier. Ceramic or polyester capacitors with low ESR and values in the range of 0.47 μF to 1 μF are recommended.

Low Dropout Regulator (LDO) Description

The TPA6047A4 contains a 4.75-V output low dropout regulator (LDO) capable of providing 120 mA with a drop of less than 150 mV from the 5-V supply. This can be used to power an external CODEC. A 10-μF decoupling capacitor is recommended at the output of the LDO as well as 0.1-μF capacitor to filter high-frequency noise from the supply line.

Layout Recommendations

Solder the exposed thermal pad (metal pad on the bottom of the part) on the TPA6047A4 QFN package to a ground pad on the PCB. For more information, see the land pattern drawing.

It is important to keep the TPA6047A4 external components close to the body of the amplifier to limit noise pickup. One should lay out the differential input leads symmetrical and close together to take advantage of the inherent common mode rejection of the TPA6047A4. The layout of the TPA6047A4 evaluation module (EVM) is a good example of component placement and the layout files are available at www.ti.com.

TAPE AND REEL INFORMATION

QUADRANT ASSIGNMENTS FOR PIN 1 ORIENTATION IN TAPE

*All dimensions are nominal

| Device | Package Type | Package Drawing | Pins | SPQ | Reel Diameter (mm) | Reel Width W1 (mm) | A0 (mm) | B0 (mm) | K0 (mm) | P1 (mm) | W (mm) | Pin1 Quadrant |
|---------------|--------------|-----------------|------|------|--------------------|--------------------|---------|---------|---------|---------|--------|---------------|
| TPA6047A4RHBR | VQFN | RHB | 32 | 3000 | 330.0 | 12.4 | 5.3 | 5.3 | 1.1 | 8.0 | 12.0 | Q2 |

TAPE AND REEL BOX DIMENSIONS

*All dimensions are nominal

| Device | Package Type | Package Drawing | Pins | SPQ | Length (mm) | Width (mm) | Height (mm) |
|---------------|--------------|-----------------|------|------|-------------|------------|-------------|
| TPA6047A4RHBR | VQFN | RHB | 32 | 3000 | 367.0 | 367.0 | 35.0 |

GENERIC PACKAGE VIEW

RHB 32

VQFN - 1 mm max height

5 x 5, 0.5 mm pitch

PLASTIC QUAD FLATPACK - NO LEAD



Images above are just a representation of the package family, actual package may vary.
Refer to the product data sheet for package details.

4224745/A

RHB (S-PVQFN-N32)

PLASTIC QUAD FLATPACK NO-LEAD

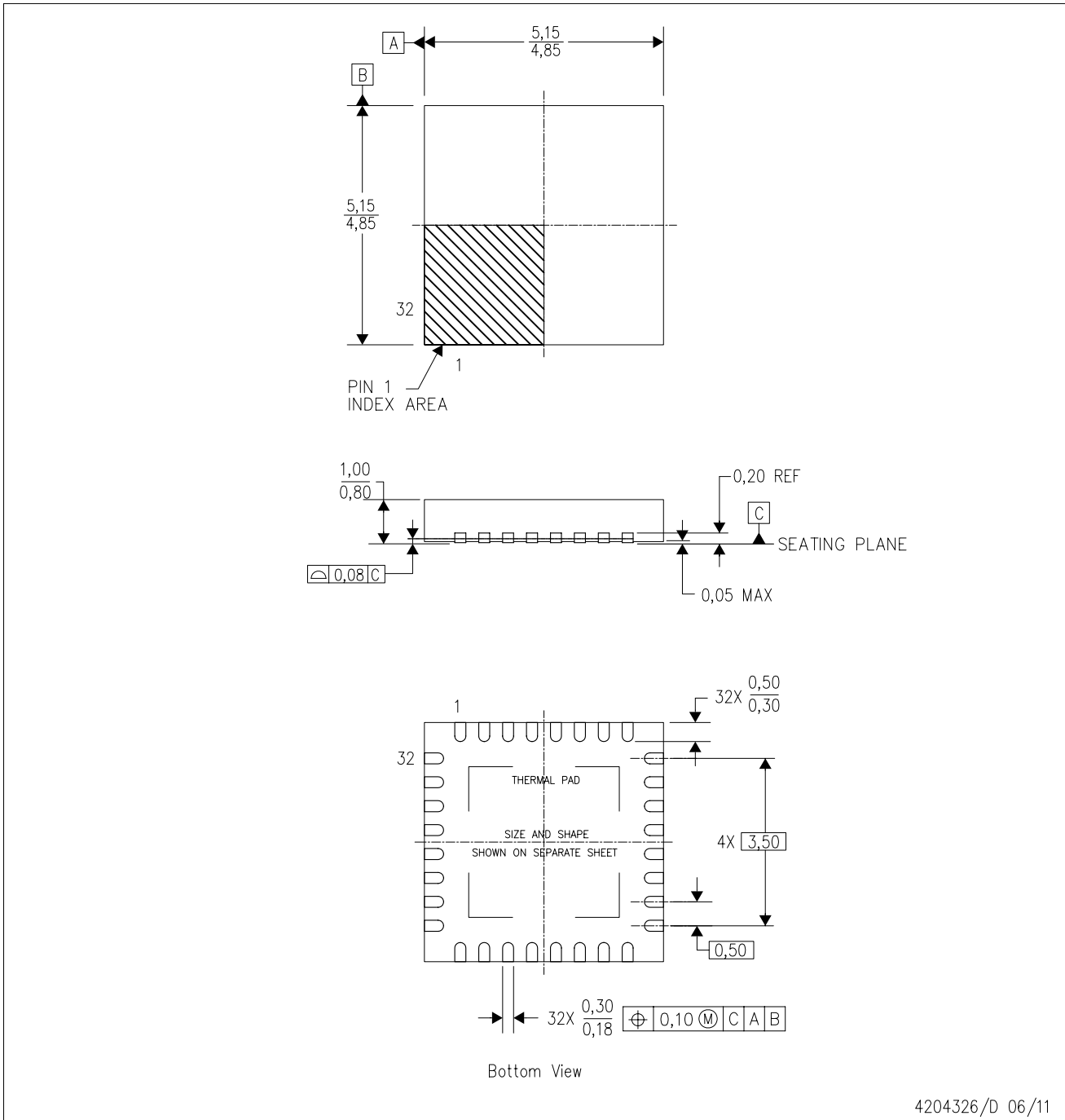

4204326/D 06/11

- NOTES:
- All linear dimensions are in millimeters. Dimensioning and tolerancing per ASME Y14.5M-1994.
 - This drawing is subject to change without notice.
 - QFN (Quad Flatpack No-Lead) Package configuration.
 - The package thermal pad must be soldered to the board for thermal and mechanical performance.
 - See the additional figure in the Product Data Sheet for details regarding the exposed thermal pad features and dimensions.
 - Falls within JEDEC MO-220.

THERMAL INFORMATION

This package incorporates an exposed thermal pad that is designed to be attached directly to an external heatsink. The thermal pad must be soldered directly to the printed circuit board (PCB). After soldering, the PCB can be used as a heatsink. In addition, through the use of thermal vias, the thermal pad can be attached directly to the appropriate copper plane shown in the electrical schematic for the device, or alternatively, can be attached to a special heatsink structure designed into the PCB. This design optimizes the heat transfer from the integrated circuit (IC).

For information on the Quad Flatpack No-Lead (QFN) package and its advantages, refer to Application Report, QFN/SON PCB Attachment, Texas Instruments Literature No. SLUA271. This document is available at www.ti.com.

The exposed thermal pad dimensions for this package are shown in the following illustration.

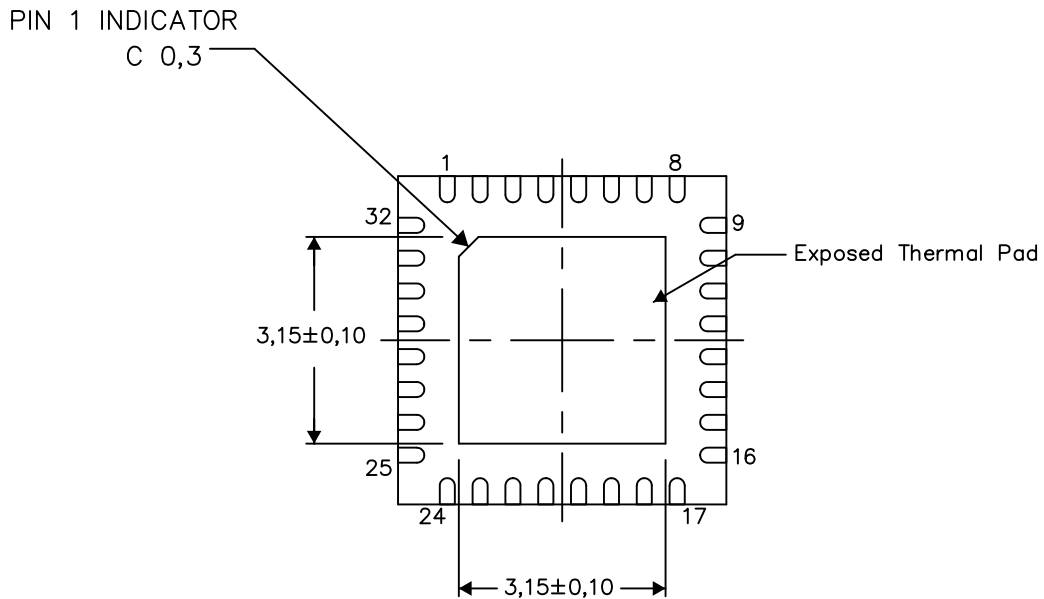

Bottom View

Exposed Thermal Pad Dimensions

4206356-3/AC 05/15

NOTE: A. All linear dimensions are in millimeters

RHB (S-PVQFN-N32)

PLASTIC QUAD FLATPACK NO-LEAD

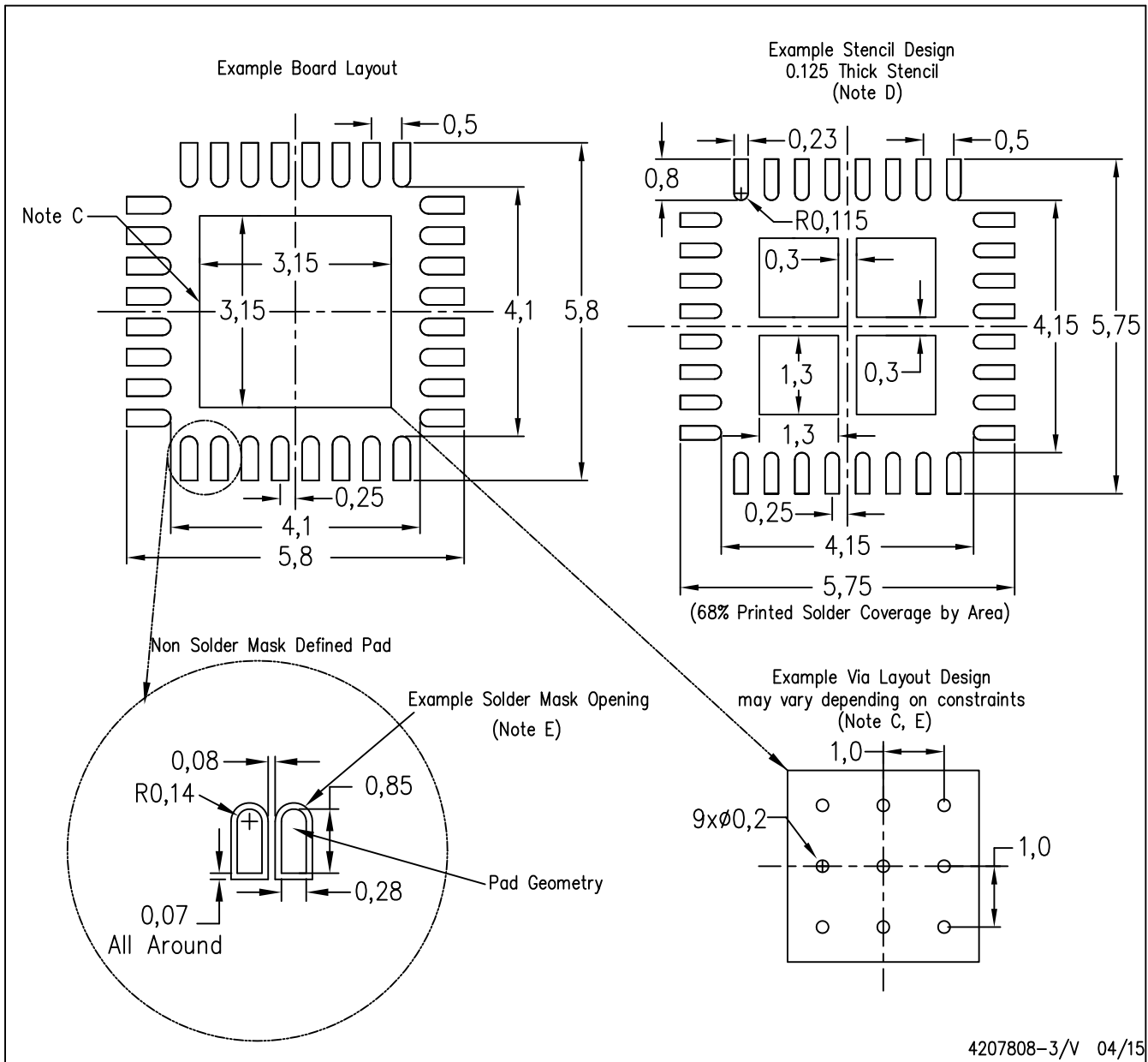

4207808-3/V 04/15

- NOTES:
- All linear dimensions are in millimeters.
 - This drawing is subject to change without notice.
 - This package is designed to be soldered to a thermal pad on the board. Refer to Application Note, Quad Flat-Pack Packages, Texas Instruments Literature No. SLUA271, and also the Product Data Sheets for specific thermal information, via requirements, and recommended board layout. These documents are available at www.ti.com <<http://www.ti.com>>.
 - Laser cutting apertures with trapezoidal walls and also rounding corners will offer better paste release. Customers should contact their board assembly site for stencil design recommendations. Refer to IPC 7525 for stencil design considerations.
 - Customers should contact their board fabrication site for recommended solder mask tolerances and via tenting recommendations for any larger diameter vias placed in the thermal pad.

IMPORTANT NOTICE AND DISCLAIMER

TI PROVIDES TECHNICAL AND RELIABILITY DATA (INCLUDING DATASHEETS), DESIGN RESOURCES (INCLUDING REFERENCE DESIGNS), APPLICATION OR OTHER DESIGN ADVICE, WEB TOOLS, SAFETY INFORMATION, AND OTHER RESOURCES "AS IS" AND WITH ALL FAULTS, AND DISCLAIMS ALL WARRANTIES, EXPRESS AND IMPLIED, INCLUDING WITHOUT LIMITATION ANY IMPLIED WARRANTIES OF MERCHANTABILITY, FITNESS FOR A PARTICULAR PURPOSE OR NON-INFRINGEMENT OF THIRD PARTY INTELLECTUAL PROPERTY RIGHTS.

These resources are intended for skilled developers designing with TI products. You are solely responsible for (1) selecting the appropriate TI products for your application, (2) designing, validating and testing your application, and (3) ensuring your application meets applicable standards, and any other safety, security, or other requirements. These resources are subject to change without notice. TI grants you permission to use these resources only for development of an application that uses the TI products described in the resource. Other reproduction and display of these resources is prohibited. No license is granted to any other TI intellectual property right or to any third party intellectual property right. TI disclaims responsibility for, and you will fully indemnify TI and its representatives against, any claims, damages, costs, losses, and liabilities arising out of your use of these resources.

TI's products are provided subject to TI's Terms of Sale (www.ti.com/legal/termsofsale.html) or other applicable terms available either on ti.com or provided in conjunction with such TI products. TI's provision of these resources does not expand or otherwise alter TI's applicable warranties or warranty disclaimers for TI products.

Mailing Address: Texas Instruments, Post Office Box 655303, Dallas, Texas 75265
Copyright © 2019, Texas Instruments Incorporated