

**Mini-Mac
Applicator**

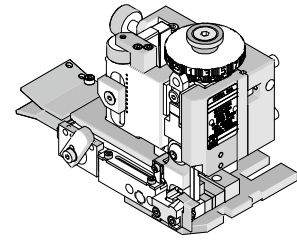

**Application Tooling
Specification Sheet**



Order No. 63891-1000

FEATURES

- Directly adapts to most automatic wire processing machines. This applicator ships from the factory set-up in the up-stroke condition for bench-top operation; however it will directly adapt to most automatic wire processing machines. Please review the applicator manual that shipped with your tool and is linked on the Molex website.
- Applicator designed to industry standard mounting and shut height 135.80mm (5.346")
- Quick set-up time; plus the crimp height, track and feed adjustments can be set without removing the applicator from the press
- Fine adjustment allows users to achieve target with little effort by adjusting in increments of .015mm (.0006") for conductor crimp height and .063mm (.0025") for insulation height
- Independent adjustment rings allow users to quickly adjust the conductor or insulation crimp height without affecting each other.
- Optimum terminal feed/indexing can be obtained with the optional terminal guide assembly, Order No. 63830-0120. See page 6.
- Easy change-over for terminal feeding (up-stroke or down-stroke). Applicator shipped as up-stroke.

SCOPE

Products: Mini-Fit Sr.™ Male and Female Crimp Terminals, 8 and (2) 12 AWG.

Terminal Series No.	Terminal Order No.		Wire Size		*Insulation Diameter		Strip Length	
			AWG	mm ²	mm	In.	mm	In.
42815	42815-0030	42815-0032	8	N/A	5.00-6.75	.197-.266	9.00-10.00	.354-.394
	42815-0031	42815-0134	(2) 12	N/A	3.50-4.00	.138-.157	11.00-12.00	.433-.472
42817	42817-0030	42817-0130	8	N/A	5.00-6.75	.197-.266	9.00-10.00	.354-.394
	42817-0031	42817-0131	(2) 12	N/A	3.50-4.00	.138-.157	11.00-12.00	.433-.472
	42817-0032	42817-0132						
	42817-1034	42817-1134						

*On Mini-Fit Sr.™ 8 AWG terminal, the insulation is stripped in both the conductor and insulation grips.

1. Crimp terminals to stranded copper wire only.
2. Lubricate terminals plated in precious metals using Molex Oiler 63801-7240.

DEFINITION OF TERMS

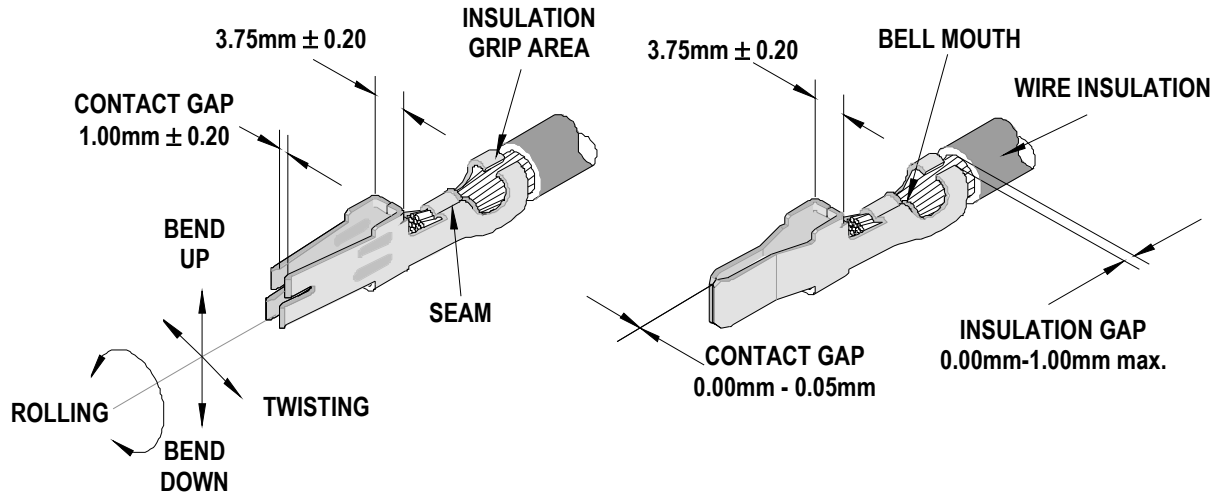

CRIMP SPECIFICATIONS

Terminal Series No.	Bell mouth		Cut-off Tab Maximum		Conductor Brush	
	mm	In.	mm	In.	mm	In.
42815	.20-.50	.008-.020	.30-.50	.012-.020	2.10-3.10	.083-.122
42817	.20-.50	.008-.020	.30-.50	.012-.020	2.10-3.10	.083-.122

Terminal Series No.	Bend up	Bend down	Twist	Roll	Punch Width (Ref)			
					Conductor		Insulation	
	Degree	Degree	mm	In	mm	In		
42815	3	3	4	8	3.90	.154	4.80	.189
42817	3	3	4	8	3.90	.154	4.80	.189

Seam
Seam shall not be open and no wire allowed out of the crimping area

After crimping, the conductor profile should measure the following.

Terminal Series No.	Wire Size		Conductor				Pull Force Minimum	
			Crimp Height		Crimp Width			
	AWG	mm ²	mm	In.	mm	In.	N	Lb.
42815	8	N/A	3.20-3.30	.126-.130	3.90	.154	400.3	90.0
	*8	N/A	3.40-3.50	.134-.138	3.90	.154	400.3	90.0
	(2) 12	N/A	3.20-3.30	.126-.130	3.90	.154	311.4	70.0
42817	8	N/A	3.20-3.30	.126-.130	3.90	.154	400.3	90.0
	*8	N/A	3.40-3.50	.134-.138	3.90	.154	400.3	90.0
	(2) 12	N/A	3.20-3.30	.126-.130	3.90	.154	311.4	70.0

* 8 AWG Hi-Flex wire (665 strands). This type of wire has very fine strands.

Please note: Extra precaution must be maintained during stripping operation to prevent loosing or breaking strands. Lost or broken strands may result in lower pull force strength and broken strands may cause a possible electric shock or shortage.

Tool Qualification Notes:

1. Pull Force should be measured with no influence from the insulation crimp.
2. The above specifications are guidelines to an optimum crimp.

Special Note:

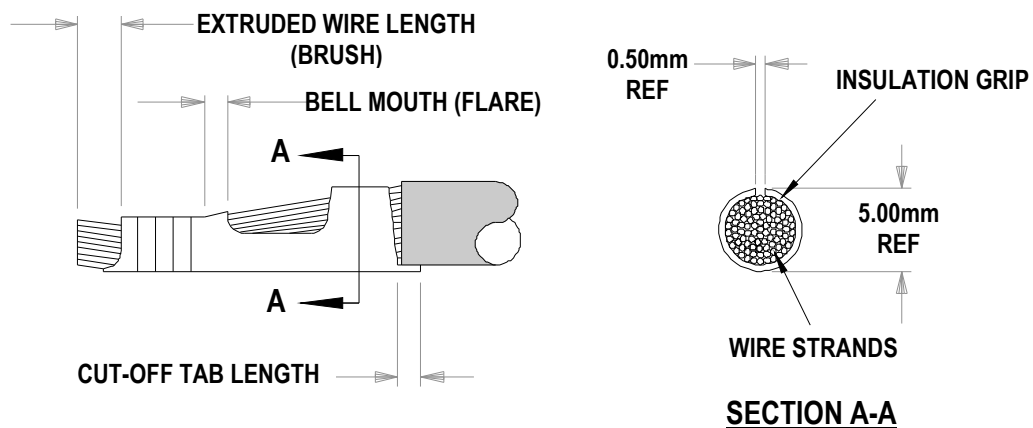

Figure 1

1. Cut-off Tab length below 0.30mm may cause the box dimension to be under recommendation. See Figure 1.
2. Wire insulation should not be crimped and insulation grip area should be formed to contain wire strands only.
3. Changing the insulation height setting may be needed to achieve the dimensions of the insulation grip in Section A-A. See Figure 1.
4. If wire strands are missed from conductor crimps, the operator should place the wires in the terminal, in the correct location, without using the wire stop/ stripper for locating the wire.

PARTS LIST

Mini-Mac Applicator 63891-1000				
Item	Order No	Engineering No.	Description	Quantity
Perishable Tooling				
	63891-1070	63891-1070	Tool Kit (All "Y" Items)	REF
1	63830-0001	63830-0001	Conductor Punch	1 Y
2	63830-0002	63830-0002	Conductor Anvil	1 Y
3	63830-0003	63830-0003	Insulation Punch	1 Y
4	63830-0004	63830-0004	Insulation Anvil	1 Y
5	63443-0045	63443-0045	Front Cut-off Plunger	1 Y
6	63443-0046	63443-0046	Front Cut-off Plunger Retainer	1 Y
6	63443-4202	63443-4202	Plunger Retainer (Non Carrier Cut-Off) To be used on all wire processors only.	0
Other Components				
7	11-18-5248	60827A115	Tooling Washer	1
8	63443-0009	63443-0009	Scrap Chute Front	1
9	63443-0024	63443-0024	Lower Tooling Key	1
10	63443-1715	63443-1715	Height Spacer	1
11	63443-2209	63443-2209	Course Spacer (9.00mm)	1
12	63443-2306	63443-2306	Fine Spacer (3.30mm)	1
13	63700-0539	63700-0539	Cut-Off Plunger Spring	1
14	63803-5105	63803-5105	Conductor Bushing	1
15	63821-0012	63821-0012	Front Cover	1
16	63821-0015	63821-0015	Wire Stop	1
17	63830-0008	63830-0008	Front Plunger Striker	1
18	63830-0117	63830-0117	Terminal Lead In	2
19	63830-0118	63830-0118	Rear Cover	1
Frame				
20	63801-3201	63801-3201	Top	1
21	63801-3281	63801-3281	Base	1
22	63801-4650	63801-4650	Track	1
Hardware				
23	N/A	N/A	M3 by 6 Long FHCS	1**
24	N/A	N/A	M3 by 6 Long SHCS	2**
25	N/A	N/A	M4 by 6 Long SHCS	5**
26	N/A	N/A	M4 by 12 Long BHCS	2**
27	N/A	N/A	M4 by 50 Long SHCS	2**
28	N/A	N/A	M5 by 12 Long SHCS	1**
29	N/A	N/A	M8 by 20 Long BHCS	1**
30	N/A	N/A	2mm by 8 Long Roll Pin	1**
<p>** Fastener parts can be obtained through most industrial supply houses by using the generic descriptions listed above in the parts list table.</p> <p>Abbreviation descriptions: SHCS = Socked Head Cap Screw, FHCS = Flat Head Cap Screw, SSS = Socket Set Screw, BHCP = Button Head Cap Screw, Roll Pin = Spiral Pin.</p>				

Older Version Applicators

Older versions of this applicator can be updated with the Terminal Guide Assembly please order the parts below.

The Terminal Guide Assembly helps to align slightly bent up or down terminals, entering the track. Recommended for use with wire processing equipment, or roughly handled terminal reels. To install the Terminal Guide assembly follow the steps below.

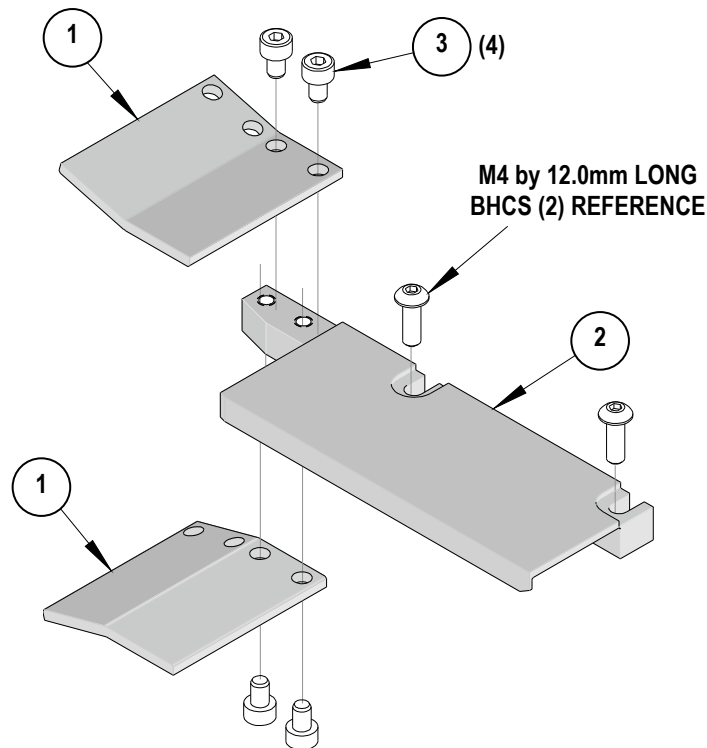

1. Remove the (2) M4 by 12 BHCS from the existing rear cover.
2. Remove the rear cover
3. Replace it with the 63830-0120 Terminal Guide Assembly.
4. Replace the (2) M4 by 12 BHCS.



Terminal Guide Assembly 63830-0120				
Item	Order No	Engineering No.	Description	Quantity
1	63830-0117	63830-0117	Terminal Lead-In	2
2	63830-0118	63830-0118	Rear Cover	1
Hardware				
3	N/A	N/A	M4 by 6 Long SHCS	4**
** Fastener parts can be obtained through most industrial supply houses by using the generic descriptions listed above in the parts list table.				
Abbreviation descriptions: SHCS = Socked Head Cap Screw, FHCS = Flat Head Cap Screw, SSS = Socket Set Screw, BHCP = Button Head Cap Screw, Roll Pin = Spiral Pin.				

NOTES

1. Molex recommends an extra perishable tooling kit be maintained at your facility.
2. Verify tooling alignment by manually cycling the press and applicator before crimping under power. Check that all screws are tight.
3. Slugs, terminals, dirt, and oil should be kept clear of work area.
4. Wear safety glasses at all times.
5. For recommended maintenance refer to the Mini-Mac Manual.

 <p>CAUTION</p>	<p>This applicator should only be used in a press with a shut height of 135.80 mm (5.346"). Tooling damage could result at a lower setting</p> <p>To prevent injury, never operate this applicator without the guards supplied with the press or wire-processing machine in place. Reference the press or wire processing manufacturer's instruction manual.</p>
 <p>CAUTION</p>	<p>Molex tooling crimp specifications are valid only when used with Molex terminals and tooling manufactured by Molex or authorized distributors ("Molex Tooling"). When using tooling other than Molex Tooling with specific Molex specific connector systems listed in our ATS documents, the Molex tooling qualification does not apply and the responsibility for full qualification of the connector system is that of the customer.</p> <p>Molex accepts no liability for connector performance or tooling support where tooling other than Molex Tooling is used, or where Molex Tooling is modified.</p>
 <p>CAUTION</p>	<p>A-620 and other industry standards do not supersede the manufacturer's specifications. Some terminals designed over 20 years ago may not meet the desired physical attributes for some of today's standards. However, these terminals will still perform electrically at an acceptable quality level based on the qualification testing and years of successful performance in the field.</p>

Contact Information

Application Tooling Support
 2200 Wellington Court
 Lisle, IL 60532 USA
 Direct +1-402-458-TOOL (8665)

Visit our website at www.molex.com/applicationtooling

Mouser Electronics

Authorized Distributor

Click to View Pricing, Inventory, Delivery & Lifecycle Information:

[Molex:](#)

[63891-1070](#)