

# LVK Series

## Four Terminal High Precision Current Sense

Current sense resistors enable the measurement of current flow in a circuit by monitoring a voltage drop across a precisely calibrated resistance. The LVK chip features four terminals, also known as a “Kelvin” configuration. This configuration enables current to be applied through two opposite terminals and a sensing voltage to be measured across the other two terminals, eliminating the resistance and temperature coefficient of the terminals for a more accurate current measurement.

Isolating the voltage and current terminals (see schematic) facilitates a very accurate current measurement. Ohmite’s proprietary technology offers an excellent Temperature Coefficient of Resistance (TCR) even for very low resistance values. The resistive element consists of a durable, anti-corrosive metal alloy that combines reliable performance with the ability to withstand harsh environments.

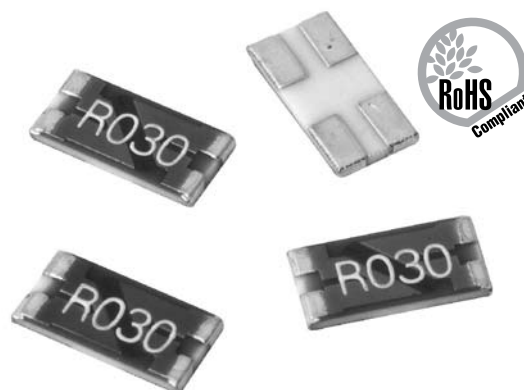

### FEATURES

- Designed for automatic insertion
- Industry standard sizes
- High-precision Kelvin connect capability in a small package

### SERIES SPECIFICATIONS

| Series | Pkg. Size | Power Rating (W @70°C) | Resistance Range (Ω)               | TCR (ppm/°C)               | Tolerance | Available Values    | Max. Over Current Max. Power | Max. Current |
|--------|-----------|------------------------|------------------------------------|----------------------------|-----------|---------------------|------------------------------|--------------|
| LVK12  | 1206      | 0.5W                   | 0.01-0.100                         | 50ppm                      | 0.5%, 1%  | E12                 | 20W                          | 20A          |
| LVK20  | 2010      | 0.75W                  | 0.01-0.05                          | 50ppm                      | 0.5%, 1%  | E12                 | 29W                          | 23A          |
| LVK24  | 2412      | 1.0W                   | 0.01-0.100                         | 50ppm                      | 0.5%, 1%  | E12                 | 38W                          | 27A          |
| LVK25  | 1224      | 2.0W                   | 0.001<br>0.002-0.004<br>0.005-0.01 | 300ppm<br>200ppm<br>100ppm | 1%        | 1, 2, 3, 5, 9, 10mΩ | 150W                         | 200A         |

### CHARACTERISTICS

|                                  |   |
|----------------------------------|---|
| <b>Res. Range</b>                | 0.001Ω - 0.010Ω   |
| <b>Operating Temp. Range</b>     | -40°C to +125°C   |
| <b>Rated Ambient Temperature</b> | +70°C   |
| <b>Resistance Tolerance</b>      | 0.5% and 1% standard  |
| <b>Temperature Coefficient</b>   | LVK12, LVK20, LVK24: 50ppm standard<br>LVK25: 100ppm, 200ppm, or 300ppm based on resistance value   |
| <b>Coating Material</b>          | epoxy resin   |
| <b>Terminals</b>                 | 100% matte tin  |
| <b>Max. Over Current</b>         | Time applied: 10ms max.<br>Interval: 60sec min.<br>Max. over current = $\sqrt{(\text{Max. power} \div \text{Resistance value})}$ or max. current, whichever is smaller. |
| <b>Storage conditions</b>        | Temperature: 5°C ~ 35°C<br>Humidity: 25% ~ 70%  |

# LVK Series

## Four Terminal High Precision Current Sense

### PERFORMANCE CHARACTERISTICS

| Test Items                          | Performance Requirements  | Test Methods / standard: JIS C 5201.1  |
|-------------------------------------|---|--|
| <b>Overload</b>                     | $\pm(0.5\%+0.0005\Omega)$   | Rated voltage x 1.5 for 5s   |
| <b>Endurance at 70°C</b>            | $\pm(0.5\%+0.0005\Omega)$   | 70°C $\pm$ 3°C, Rated voltage 1.5h ON, 0.5h OFF, 1000h                             |
| <b>Moisture resistance</b>          | $\pm(0.5\%+0.0005\Omega)$   | 60°C $\pm$ 2°C, 90%~95% RH, Rated voltage 1.5h ON, 0.5h OFF, 1000h                 |
| <b>Rapid change of temperature</b>  | $\pm(0.5\%+0.0005\Omega)$   | -40°C (30min.)/+125°C (30min.), 5 cycles   |
| <b>Resistance to soldering heat</b> | $\pm(0.5\%+0.0005\Omega)$   | 260°C $\pm$ 5°C for 10s $\pm$ 1s   |
| <b>Substrate bending</b>            | $\pm(0.5\%+0.0005\Omega)$   | Bending width: 2mm for 10s $\pm$ 1s, Glass epoxy substrate with thickness of 1.6mm |
| <b>Solderability</b>                | 95% or more of the electrode surface shall be covered with new solder | 245°C $\pm$ 5°C for 3s $\pm$ 0.5s  |

### Reflow Temperature Profile

For lead free soldering (Sn-Ag-Cu solder)

Preheating: 130° ~ 180° 60s ~ 90s  
 Heating: Over 220° 30s ~ 90s  
 Peak: 240° ~ 260° Max. 10s

Ramp-up rate: max 3°C/sec.  
 Time above liquidous: 60 – 150 sec.  
 Ramp-down rate: max 6°C/sec.  
 Max. number of reflow: 2

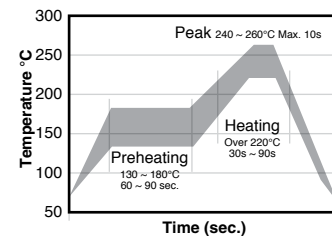

### DIMENSIONS

(mm)

LVK12, LVK20, LVK24 (0.5, 0.75 & 1 watt)

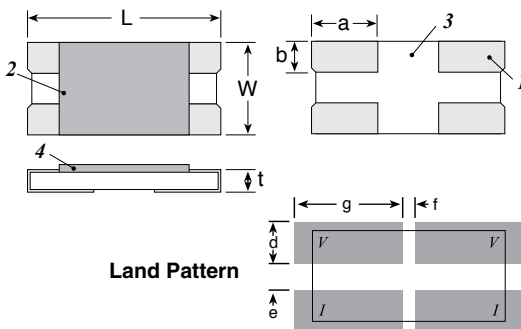

LVK25 (2 watt)

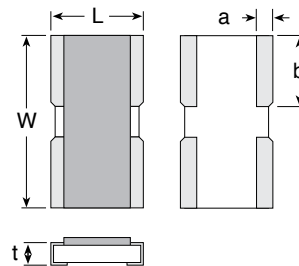

### Schematic

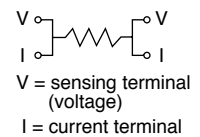

Layout for illustration only, part can be rotated 180° without effect to the circuit.

Note that LVK25 has a vertical orientation with the current flow along the short edge of the resistor.

| Size         | L             | W             | t              | a             | b              | d    | e    | f    | g    |
|--------------|---------------|---------------|----------------|---------------|----------------|------|------|------|------|
| LVK12 (1206) | 3.2 $\pm$ 0.2 | 1.6 $\pm$ 0.2 | 0.5 $\pm$ 0.15 | 1.0 $\pm$ 0.2 | 0.55 $\pm$ 0.2 | 1.10 | 0.30 | 1.00 | 1.75 |
| LVK20 (2010) | 5.0 $\pm$ 0.2 | 2.5 $\pm$ 0.2 | 0.5 $\pm$ 0.15 | 1.7 $\pm$ 0.2 | 0.9 $\pm$ 0.2  | 1.55 | 0.50 | 1.40 | 2.55 |
| LVK24 (2412) | 6.4 $\pm$ 0.2 | 3.2 $\pm$ 0.2 | 0.5 $\pm$ 0.15 | 2.1 $\pm$ 0.2 | 1.2 $\pm$ 0.2  | 1.90 | 0.60 | 2.00 | 3.25 |
| LVK25 (1224) | 3.2 $\pm$ 0.2 | 6.4 $\pm$ 0.2 | 0.5 $\pm$ 0.2  | 0.4 $\pm$ 0.2 | 2.7 $\pm$ 0.2  | 1.40 | 2.20 | 1.00 | 3.30 |

# LVK Series

## Four Terminal High Precision Current Sense

### TAPE AND REEL

(mm)

Tape

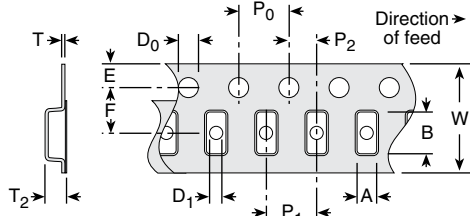

|    | LVK12        | LVK20       | LVK24       | LVK25       |
|----|--------------|-------------|-------------|-------------|
| A  | 1.90 ±0.10   | 2.90 ±0.1   | 3.43 ±0.2   | 3.43 ±0.2   |
| B  | 3.50 ±0.10   | 5.35 ±0.1   | 6.63 ±0.2   | 6.63 ±0.2   |
| W  | 8.0 ±0.2     | 12.0 ±0.2   | 12.0 ±0.3   | 12.0 ±0.3   |
| F  | 3.5 ±0.05    | 5.5 ±0.05   | 5.5 ±0.05   | 5.5 ±0.05   |
| E  | 1.75 ±0.1    | 1.75 ±0.1   | 1.75 ±0.1   | 1.75 ±0.1   |
| P0 | 4.0 ±0.1     | 4.0 ±0.1    | 4.0 ±0.1    | 4.0 ±0.1    |
| P1 | 4.0 ±0.1     | 4.0 ±0.1    | 4.0 ±0.1    | 4.0 ±0.1    |
| P2 | 2.0 ±0.05    | 2.0 ±0.05   | 2.0 ±0.05   | 2.0 ±0.05   |
| D0 | 1.5 +0.1/-0  | 1.5 +0.1/-0 | 1.5 +0.1/-0 | 1.5 +0.1/-0 |
| D1 | 1.0 +0.20/-0 | 1.5 +0.2/-0 | 1.5 +0.2/-0 | 1.5 +0.2/-0 |
| T  | 0.2 ±0.05    | 0.2 ±0.05   | 0.2 ±0.05   | 0.2 ±0.05   |
| T2 | 1.0 ±0.2     | 1.0 ±0.2    | 1.0 ±0.2    | 1.0 ±0.2    |

Reel

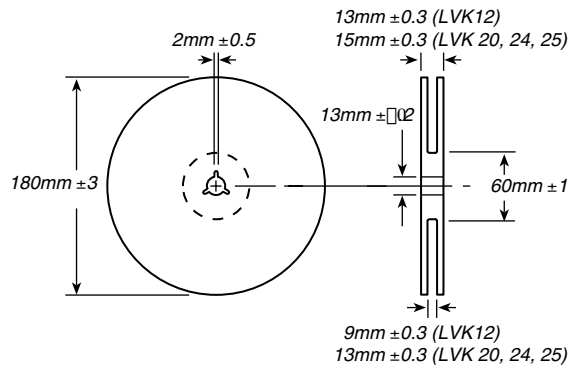

| Series | Qty/Reel |
|--------|----------|
| LVK12  | 5000     |
| LVK20  | 1000     |
| LVK24  | 1000     |
| LVK25  | 1000     |

### ORDERING INFORMATION

RoHS Compliant

**LVK25R005FER**

|        |  |              |                    |             |
|--------|--|--------------|--------------------|-------------|
| Series | Case Size  | Ohms         | Tolerance          | Tape & Reel |
|        | 12 = 1206<br>20 = 2010<br>24 = 2412<br>25 = 1224 | R005 = 0.005 | D = 0.5%<br>F = 1% |             |

#### Standard values

| LVK12 | LVK20 | LVK24 | LVK25 | LVK12          | LVK20 | LVK24 | LVK25 |
|-------|-------|-------|-------|----------------|-------|-------|-------|
| 0.01  | 0.01  | 0.01  | 0.001 | 0.5% Tolerance |       |       |       |
| 0.012 |       | 0.012 | 0.002 | 0.01           | 0.01  | 0.01  | 0.001 |
|       | 0.015 | 0.015 | 0.003 | 0.015          | 0.015 | 0.015 | 0.002 |
|       |       |       | 0.005 | 0.02           | 0.02  | 0.02  | 0.003 |
| 0.02  | 0.02  | 0.02  | 0.01  | 0.025          | 0.025 | 0.025 | 0.005 |
| 0.024 | 0.027 | 0.025 |       | 0.03           | 0.03  | 0.03  | 0.010 |
| 0.03  | 0.03  | 0.03  |       | 0.033          |       | 0.033 |       |
| 0.033 |       | 0.033 |       | 0.039          |       |       |       |
| 0.039 | 0.039 | 0.039 |       | 0.05           | 0.05  | 0.05  |       |
| 0.047 |       | 0.047 |       | 0.075          |       |       |       |
| 0.05  | 0.05  | 0.05  |       | 0.10           |       | 0.10  |       |
| 0.075 |       | 0.075 |       |                |       |       |       |
| 0.10  |       | 0.10  |       |                |       |       |       |

# Mouser Electronics

Authorized Distributor

Click to View Pricing, Inventory, Delivery & Lifecycle Information:

## Ohmite:

[LVK25R010FER](#) [LVK12R010DER](#) [LVK24R015FER](#) [LVK20R015FER](#) [LVK25R003FER](#) [LVK24R012FER](#)  
[LVK12R012FER](#) [LVK24R030FER](#) [LVK20R030FER](#) [LVK24R020DER](#) [LVK12R020FER](#) [LVK20R020DER](#)  
[LVK24R030DER](#) [LVK12R050DER](#) [LVK25R001FER](#) [LVK20R030DER](#) [LVK20R050FER](#) [LVK25R005FER](#)  
[LVK20R027FER](#) [LVK24R050FER](#) [LVK12R030FER](#) [LVK24R050DER](#) [LVK12R030DER](#) [LVK24R039FER](#)  
[LVK20R039FER](#) [LVK24R047FER](#) [LVK25R002FER](#) [LVK20R050DER](#) [LVK24R020FER](#) [LVK20R020FER](#)  
[LVK12R047FER](#) [LVK12R010FER](#) [LVK12R050FER](#) [LVK20R010DER](#) [LVK12R020DER](#) [LVK12R024FER](#)  
[LVK24R010DER](#) [LVK20R010FER](#) [LVK24R010FER](#) [LVK25R010DER](#) [LVK12R033FER](#) [LVK24R025FER](#)  
[LVK12R075DER](#) [LVK24R075FER](#) [LVK24R033FER](#) [LVK24R033DER](#) [LVK24R025DER](#) [LVK24R015DER](#)  
[LVK20R025DER](#) [LVK12R075FER](#) [LVK12R039FER](#) [LVK12R039DER](#) [LVK25R001DER](#) [LVK20R015DER](#)  
[LVK25R002DER](#) [LVK12R033DER](#) [LVK25R003DER](#) [LVK25R005DER](#) [LVK24R039DER](#) [LVK24R100FER](#)  
[LVK12R100FER](#) [LVK12R015DER](#) [LVK12R100DER](#) [LVK24R100DER](#)