

PCB terminal block - FK-MPT 0,5/ 6-3,5 - 1891108

Please be informed that the data shown in this PDF Document is generated from our Online Catalog. Please find the complete data in the user's documentation. Our General Terms of Use for Downloads are valid (<http://phoenixcontact.com/download>)

PCB terminal block, Nominal current: 4 A, Nom. voltage: 250 V, Pitch: 3.5 mm, Number of positions: 6, Connection method: Push-in spring connection, Mounting: Wave soldering, Conductor/PCB connection direction: 90 °, Color: green

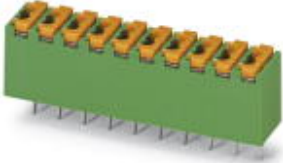

The figure shows a 10-position version of the product

Product Features

- Miniature connection terminal for solid conductors
- More user friendly thanks to direct plug-in technology with release button
- Potentials can be easily looped through thanks to the double connection

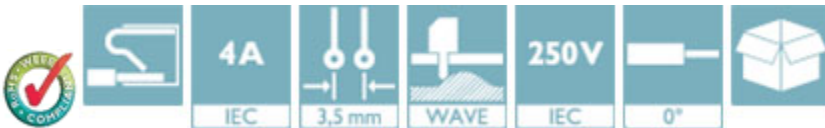

Key Commercial Data

Packing unit	1 pc
Minimum order quantity	50 pc
Weight per Piece (excluding packing)	2.44 g
Custom tariff number	85369010
Country of origin	Germany

Technical data

Dimensions

Length	7 mm
Pitch	3.50 mm
Dimension a	17.5 mm
Width	21.5 mm
Constructional height	12.4 mm
Height	15.9 mm
Length of the solder pin	3.5 mm
Pin dimensions	0,4 x 0,9 mm

PCB terminal block - FK-MPT 0,5/ 6-3,5 - 1891108

Technical data

Dimensions

Hole diameter	1 mm
---------------	------

General

Range of articles	FK-MPT 0,5/..-V
Insulating material group	IIIa
Rated surge voltage (III/3)	2.5 kV
Rated surge voltage (III/2)	2.5 kV
Rated surge voltage (II/2)	2.5 kV
Rated voltage (III/3)	160 V
Rated voltage (III/2)	250 V
Rated voltage (II/2)	250 V
Connection in acc. with standard	EN-VDE
Nominal current I_N	4 A
Nominal cross section	0.5 mm ²
Maximum load current	4 A (with 0.5 mm ² conductor cross section)
Insulating material	PBT
Solder pin surface	Sn
Flammability rating according to UL 94	V0
Stripping length	6.5 mm
Number of positions	6

Connection data

Conductor cross section solid min.	0.12 mm ²
Conductor cross section solid max.	0.5 mm ²
Conductor cross section AWG min.	26
Conductor cross section AWG max.	20

Standards and Regulations

Connection in acc. with standard	EN-VDE
	CUL
Flammability rating according to UL 94	V0

Classifications

eCl@ss

eCl@ss 4.0	272607xx
eCl@ss 4.1	27141109
eCl@ss 5.0	27141190
eCl@ss 5.1	27141190

PCB terminal block - FK-MPT 0,5/ 6-3,5 - 1891108

Classifications

eCl@ss

eCl@ss 6.0	27261101
eCl@ss 7.0	27440401
eCl@ss 8.0	27440401
eCl@ss 9.0	27440401

ETIM

ETIM 3.0	EC001121
ETIM 4.0	EC002643
ETIM 5.0	EC002643

UNSPSC

UNSPSC 6.01	30211801
UNSPSC 7.0901	39121432
UNSPSC 11	34131203
UNSPSC 12.01	39121432
UNSPSC 13.2	39121432

Approvals

Approvals

Approvals

UL Recognized / SEV / cUL Recognized / EAC / CCA / EAC / cULus Recognized

Ex Approvals

Approvals submitted

Approval details

UL Recognized 		
	B	D
mm ² /AWG/kcmil	28-20	28-20
Nominal current I _N	4 A	4 A

PCB terminal block - FK-MPT 0,5/ 6-3,5 - 1891108

Approvals

	B	D
Nominal voltage UN	300 V	300 V

SEV	
mm ² /AWG/kcmil	0.5
Nominal current IN	3 A
Nominal voltage UN	160 V

cUL Recognized 		
	B	D
mm ² /AWG/kcmil	28-20	28-20
Nominal current IN	4 A	4 A
Nominal voltage UN	300 V	300 V

EAC

CCA	
mm ² /AWG/kcmil	0.5
Nominal current IN	3 A
Nominal voltage UN	160 V

EAC

cULus Recognized 	

Accessories

Accessories

PCB headers

PCB terminal block - FK-MPT 0,5/ 6-3,5 - 1891108

Accessories

Base strip - FK-MPT 0,5/ 6-IC-3,5 - 1905382



Header, Nominal current: 3 A, Rated voltage (III/2): 250 V, Number of positions: 6, Pitch: 3.5 mm, Color: black, Contact surface: Tin, Mounting: THR soldering, The touch-protected basic strip, serves to accommodate the FK-MPT 0,5 PCB terminal block.

Base strip - FK-MPT 0,5/ 6-ICV-3,5 - 1905531



Header, Nominal current: 3 A, Rated voltage (III/2): 250 V, Number of positions: 6, Pitch: 3.5 mm, Color: black, Contact surface: Tin, Mounting: THR soldering, The touch-protected basic strip, serves to accommodate the FK-MPT 0,5 PCB terminal block.

Screwdriver tools

Screwdriver - SZF 0-0,4X2,5 - 1204504



Actuation tool, for ST terminal blocks, also suitable for use as a bladed screwdriver, size: 0.4 x 2.5 x 75 mm, 2-component grip, with non-slip grip

Additional products

Base strip - FK-MPT 0,5/ 6-IC-3,5 - 1905382



Header, Nominal current: 3 A, Rated voltage (III/2): 250 V, Number of positions: 6, Pitch: 3.5 mm, Color: black, Contact surface: Tin, Mounting: THR soldering, The touch-protected basic strip, serves to accommodate the FK-MPT 0,5 PCB terminal block.

Base strip - FK-MPT 0,5/ 6-ICV-3,5 - 1905531



Header, Nominal current: 3 A, Rated voltage (III/2): 250 V, Number of positions: 6, Pitch: 3.5 mm, Color: black, Contact surface: Tin, Mounting: THR soldering, The touch-protected basic strip, serves to accommodate the FK-MPT 0,5 PCB terminal block.

PCB terminal block - FK-MPT 0,5/ 6-3,5 - 1891108

Accessories

Drawings

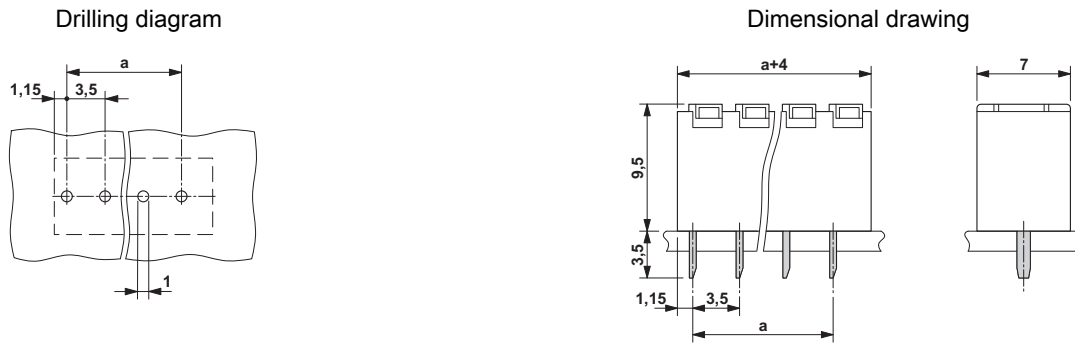

Diagram

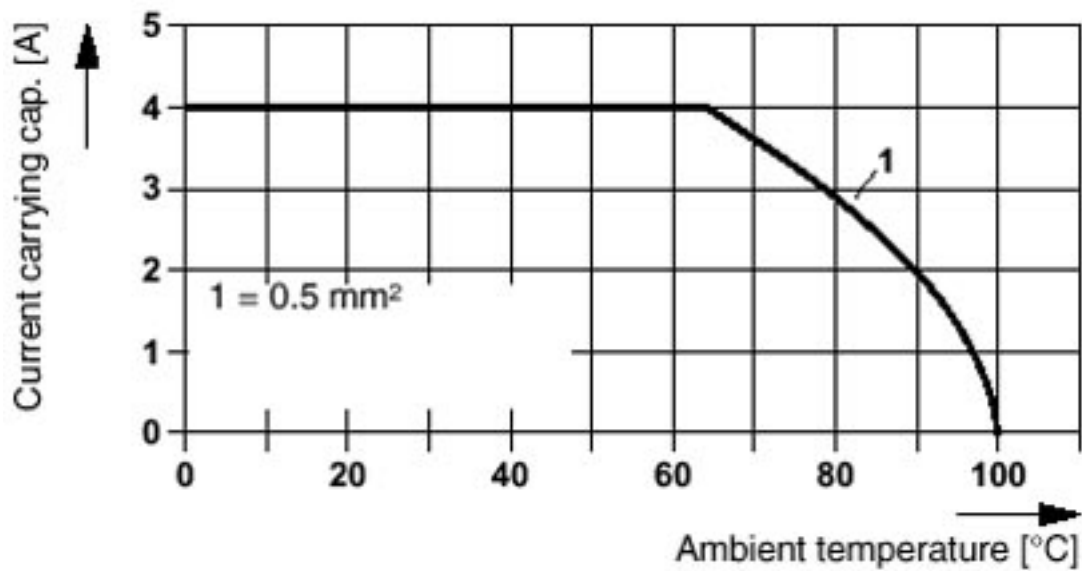

Mouser Electronics

Authorized Distributor

Click to View Pricing, Inventory, Delivery & Lifecycle Information:

[Phoenix Contact:](#)

[1891108](#)