

FEATURES

- Two 1.6 GHz, differential clock inputs
- 5 programmable dividers, 1 to 32, all integers
- 3 independent 1.2 GHz LVPECL outputs
- Additive output jitter 225 fs rms
- 2 independent 800 MHz/250 MHz LVDS/CMOS clock outputs
- Additive output jitter: 275 fs rms
- Serial control port
- Space-saving 48-lead LFCSP

ENHANCED PRODUCT FEATURES

- Supports defense and aerospace applications (AQEC standard)
- Military temperature range (-55°C to $+85^{\circ}\text{C}$)
- Controlled manufacturing baseline
- 1 assembly/test site
- 1 fabrication site
- Enhanced product change notification
- Qualification data available on request

APPLICATIONS

- Low jitter, low phase noise clock distribution
- Clocking high speed ADCs, DACs, DDSs, DDCs, DUCs, MxFEs
- Defense and aerospace applications

GENERAL DESCRIPTION

The [AD9512-EP](#) provides a multi-output clock distribution in a design that emphasizes low jitter and low phase noise to maximize data converter performance. Other applications with demanding phase noise and jitter requirements can also benefit from this device.

There are five independent clock outputs. Three outputs are LVPECL (1.2 GHz), and two are selectable as either LVDS (800 MHz) or CMOS (250 MHz) levels.

Each output has a programmable divider that can be bypassed or set to divide by any integer up to 32. The phase of one clock output relative to another clock output can be varied by means of a divider phase select function that serves as a coarse timing adjustment.

FUNCTIONAL BLOCK DIAGRAM

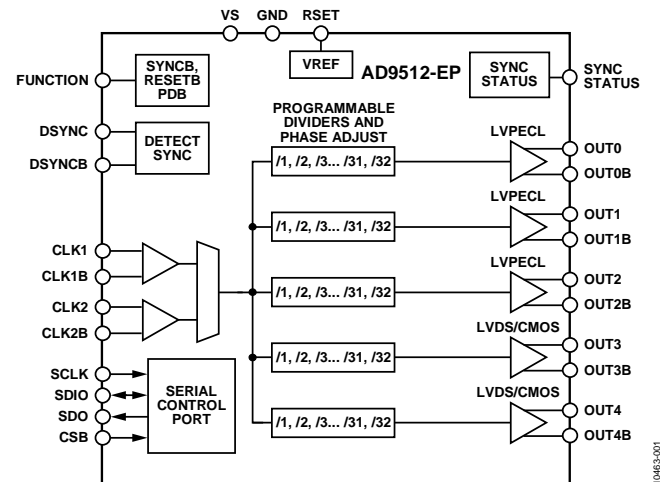

Figure 1.

The [AD9512-EP](#) is ideally suited for data converter clocking applications where maximum converter performance is achieved by encode signals with subpicosecond jitter.

The [AD9512-EP](#) is available in a 48-lead LFCSP and can be operated from a single 3.3 V supply. The temperature range is -55°C to $+85^{\circ}\text{C}$.

Additional application and technical information can be found in the [AD9512](#) data sheet.

Note that the delay block element that exists in Channel 4 of the [AD9512](#) standard product is not supported in this [AD9512-EP](#) version.

TABLE OF CONTENTS

Features	1	Clock Output Additive Time Jitter.....	8
Enhanced Product Features	1	Serial Control Port	10
Applications.....	1	FUNCTION Pin	10
Functional Block Diagram	1	SYNC STATUS Pin	11
General Description	1	Power.....	11
Revision History	2	Absolute Maximum Ratings	12
Specifications.....	3	Thermal Resistance.....	12
Clock Inputs	3	Pin Configuration and Function Descriptions.....	13
Clock Outputs.....	3	Typical Performance Characteristics	15
Timing Characteristics	4	Outline Dimensions	18
Clock Output Phase Noise	5	Ordering Guide	18

REVISION HISTORY

11/2018—Rev. 0 to Rev. A

Changes to Figure 2.....	13
Updated Outline Dimensions	18
Changes to Ordering Guide	18

3/2012—Revision 0: Initial Version

SPECIFICATIONS

The typical value is given for $V_S = 3.3 \text{ V} \pm 5\%$; $T_A = 25^\circ\text{C}$, $R_{SET} = 4.12 \text{ k}\Omega$, unless otherwise noted. Minimum and maximum values are given over full V_S and T_A (-55°C to $+85^\circ\text{C}$) variation.

CLOCK INPUTS

Table 1.

Parameter	Min	Typ	Max	Unit	Test Conditions/Comments
CLOCK INPUTS (CLK1, CLK2) ¹					
Input Frequency	0		1.6	GHz	
Input Sensitivity		150 ²		mV p-p	Jitter performance can be improved with higher slew rates (greater swing).
Input Level			2 ³	V p-p	Larger swings turn on the protection diodes and can degrade jitter performance.
Input Common-Mode Voltage, V_{CM}	1.45	1.6	1.7	V	Self-biased; enables ac coupling; at full temperature range.
	1.5	1.6	1.7	V	At -40°C to $+85^\circ\text{C}$.
Input Common-Mode Range, V_{CMR}	1.3		1.8	V	With 200 mV p-p signal applied; dc-coupled.
Input Sensitivity, Single-Ended		150		mV p-p	CLK2 ac-coupled; CLK2B ac bypassed to RF ground.
Input Resistance	4.0	4.8	5.6	k Ω	Self-biased.
Input Capacitance		2		pF	

¹ CLK1 and CLK2 are electrically identical; each can be used as either differential or single-ended input.

² With a 50 Ω termination, this is -12.5 dBm .

³ With a 50 Ω termination, this is $+10 \text{ dBm}$.

CLOCK OUTPUTS

Table 2.

Parameter	Min	Typ	Max	Unit	Test Conditions/Comments
LVPECL CLOCK OUTPUTS					
OUT0, OUT1, OUT2; Differential					Termination = 50 Ω to $V_S - 2 \text{ V}$
Output Frequency			1200	MHz	Output level 0x3D (0x3E) (0x3F)[3:2] = 10b
Output High Voltage (V_{OH})	$V_S - 1.22$	$V_S - 0.98$	$V_S - 0.93$	V	See Figure 10
Output Low Voltage (V_{OL})	$V_S - 2.10$	$V_S - 1.80$	$V_S - 1.67$	V	
Output Differential Voltage (V_{OD})	660	810	965	mV	
LVDS CLOCK OUTPUTS					
OUT3, OUT4; Differential					Termination = 100 Ω differential; default
Output Frequency			800	MHz	Output level 0x40 (0x41)[2:1] = 01b
Differential Output Voltage (V_{OD})	250	360	450	mV	3.5 mA termination current
Delta V_{OD}			25	mV	See Figure 11
Output Offset Voltage (V_{OS})	1.05	1.23	1.375	V	At full temperature range
	1.125	1.23	1.375	V	At -40°C to $+85^\circ\text{C}$
Delta V_{OS}			25	mV	
Short-Circuit Current (I_{SA} , I_{SB})		14	24	mA	Output shorted to GND
CMOS CLOCK OUTPUTS					
OUT3, OUT4					Single-ended measurements;
Output Frequency			250	MHz	B outputs: inverted, termination open
Output Voltage High (V_{OH})	$V_S - 0.1$			V	With 5 pF load each output; see Figure 12
Output Voltage Low (V_{OL})			0.1	V	At 1 mA load
				V	At 1 mA load

TIMING CHARACTERISTICS

Table 3.

Parameter	Min	Typ	Max	Unit	Test Conditions/Comments
LVPECL					Termination = 50 Ω to $V_S - 2V$ Output level 0x3D (0x3E) (0x3F)[3:2] = 10b
Output Rise Time, t_{RP}		130	180	ps	20% to 80%, measured differentially
Output Fall Time, t_{FP}		130	180	ps	80% to 20%, measured differentially
PROPAGATION DELAY, t_{PECL} , CLK-TO-LVPECL OUT ¹					
Divide = Bypass	320	490	635	ps	At full temperature range
	335	490	635	ps	At -40°C to +85°C
Divide = 2 to 32	360	545	695	ps	At full temperature range
	375	545	695	ps	At -40°C to +85°C
Variation with Temperature		0.5		ps/°C	
OUTPUT SKEW, LVPECL OUTPUTS					
OUT1 to OUT0 on Same Device, t_{SKP}^2	70	100	140	ps	
OUT1 to OUT2 on Same Device, t_{SKP}^2	15	45	80	ps	
OUT0 to OUT2 on Same Device, t_{SKP}^2	45	65	90	ps	
All LVPECL OUT Across Multiple Devices, $t_{SKP_AB}^3$			275	ps	
Same LVPECL OUT Across Multiple Devices, $t_{SKP_AB}^3$			130	ps	
LVDS					Termination = 100 Ω differential Output level 0x40 (0x41) [2:1] = 01b 3.5 mA termination current
Output Rise Time, t_{RL}		200	350	ps	20% to 80%, measured differentially
Output Fall Time, t_{FL}		210	350	ps	80% to 20%, measured differentially
PROPAGATION DELAY, t_{LVDS} , CLK-TO-LVDS OUT ¹					
OUT3 to OUT4					
Divide = Bypass	0.97	1.33	1.59	ns	At full temperature range
	0.99	1.33	1.59	ns	At -40°C to +85°C
Divide = 2 to 32	1.02	1.38	1.64	ns	At full temperature range
	1.04	1.38	1.64	ns	At -40°C to +85°C
Variation with Temperature		0.9		ps/°C	
OUTPUT SKEW, LVDS OUTPUTS					
OUT3 to OUT4 on Same Device, t_{SKV}^2	-85		+270	ps	
All LVDS OUTs Across Multiple Devices, $t_{SKV_AB}^3$			450	ps	
Same LVDS OUT Across Multiple Devices, $t_{SKV_AB}^3$			325	ps	
CMOS					B outputs are inverted; termination = open
Output Rise Time, t_{RC}		681	865	ps	20% to 80%; $C_{LOAD} = 3$ pF
Output Fall Time, t_{FC}		646	992	ps	80% to 20%; $C_{LOAD} = 3$ pF
PROPAGATION DELAY, t_{CMOS} , CLK-TO-CMOS OUT ¹					
Divide = Bypass	1.0	1.39	1.71	ns	At full temperature range
	1.02	1.39	1.71	ns	At -40°C to +85°C
Divide = 2 to 32	1.05	1.44	1.76	ns	At full temperature range
	1.07	1.44	1.76	ns	At -40°C to +85°C
Variation with Temperature		1		ps/°C	
OUTPUT SKEW, CMOS OUTPUTS					
OUT3 to OUT4 on Same Device, t_{SKC}^2	-140	+145	+300	ps	
All CMOS OUT Across Multiple Devices, $t_{SKC_AB}^3$			650	ps	
Same CMOS OUT Across Multiple Devices, $t_{SKC_AB}^3$			500	ps	
LVPECL-TO-LVDS OUT					Everything the same; different logic type
Output Skew, t_{SKP_V}	0.73	0.92	1.14	ns	LVPECL to LVDS on same device
LVPECL-TO-CMOS OUT					Everything the same; different logic type
Output Skew, t_{SKP_C}	0.87	1.14	1.43	ns	LVPECL to CMOS on same device

Parameter	Min	Typ	Max	Unit	Test Conditions/Comments
LVDS-TO-CMOS OUT Output Skew, t_{skv_c}	158	353	506	ps	Everything the same; different logic type LVDS to CMOS on same device

¹ The measurements are for CLK1. For CLK2, add approximately 25 ps.

² This is the difference between any two similar delay paths within a single device operating at the same voltage and temperature.

³ This is the difference between any two similar delay paths across multiple devices operating at the same voltage and temperature.

CLOCK OUTPUT PHASE NOISE

Table 4.

Parameter	Min	Typ	Max	Unit	Test Conditions/Comments
CLK1-TO-LVPECL ADDITIVE PHASE NOISE					Input slew rate > 1 V/ns
CLK1 = 622.08 MHz, OUT = 622.08 MHz					
Divide Ratio = 1					
at 10 Hz Offset		-125		dBc/Hz	
at 100 Hz Offset		-132		dBc/Hz	
at 1 kHz Offset		-140		dBc/Hz	
at 10 kHz Offset		-148		dBc/Hz	
at 100 kHz Offset		-153		dBc/Hz	
>1 MHz Offset		-154		dBc/Hz	
CLK1 = 622.08 MHz, OUT = 155.52 MHz					
Divide Ratio = 4					
at 10 Hz Offset		-128		dBc/Hz	
at 100 Hz Offset		-140		dBc/Hz	
at 1 kHz Offset		-148		dBc/Hz	
at 10 kHz Offset		-155		dBc/Hz	
at 100 kHz Offset		-161		dBc/Hz	
>1 MHz Offset		-161		dBc/Hz	
CLK1 = 622.08 MHz, OUT = 38.88 MHz					
Divide Ratio = 16					
at 10 Hz Offset		-135		dBc/Hz	
at 100 Hz Offset		-145		dBc/Hz	
at 1 kHz Offset		-158		dBc/Hz	
at 10 kHz Offset		-165		dBc/Hz	
at 100 kHz Offset		-165		dBc/Hz	
>1 MHz Offset		-166		dBc/Hz	
CLK1 = 491.52 MHz, OUT = 61.44 MHz					
Divide Ratio = 8					
at 10 Hz Offset		-131		dBc/Hz	
at 100 Hz Offset		-142		dBc/Hz	
at 1 kHz Offset		-153		dBc/Hz	
at 10 kHz Offset		-160		dBc/Hz	
at 100 kHz Offset		-165		dBc/Hz	
>1 MHz Offset		-165		dBc/Hz	
CLK1 = 491.52 MHz, OUT = 245.76 MHz					
Divide Ratio = 2					
at 10 Hz Offset		-125		dBc/Hz	
at 100 Hz Offset		-132		dBc/Hz	
at 1 kHz Offset		-140		dBc/Hz	
at 10 kHz Offset		-151		dBc/Hz	
at 100 kHz Offset		-157		dBc/Hz	
>1 MHz Offset		-158		dBc/Hz	

Parameter	Min	Typ	Max	Unit	Test Conditions/Comments
CLK1 = 245.76 MHz, OUT = 61.44 MHz Divide Ratio = 4					
at 10 Hz Offset		-138		dBc/Hz	
at 100 Hz Offset		-144		dBc/Hz	
at 1 kHz Offset		-154		dBc/Hz	
at 10 kHz Offset		-163		dBc/Hz	
at 100 kHz Offset		-164		dBc/Hz	
>1 MHz Offset		-165		dBc/Hz	
CLK1-TO-LVDS ADDITIVE PHASE NOISE					
CLK1 = 622.08 MHz, OUT = 622.08 MHz Divide Ratio = 1					
at 10 Hz Offset		-100		dBc/Hz	
at 100 Hz Offset		-110		dBc/Hz	
at 1 kHz Offset		-118		dBc/Hz	
at 10 kHz Offset		-129		dBc/Hz	
at 100 kHz Offset		-135		dBc/Hz	
at 1 MHz Offset		-140		dBc/Hz	
>10 MHz Offset		-148		dBc/Hz	
CLK1 = 622.08 MHz, OUT = 155.52 MHz Divide Ratio = 4					
at 10 Hz Offset		-112		dBc/Hz	
at 100 Hz Offset		-122		dBc/Hz	
at 1 kHz Offset		-132		dBc/Hz	
at 10 kHz Offset		-142		dBc/Hz	
at 100 kHz Offset		-148		dBc/Hz	
at 1 MHz Offset		-152		dBc/Hz	
>10 MHz Offset		-155		dBc/Hz	
CLK1 = 491.52 MHz, OUT = 245.76 MHz Divide Ratio = 2					
at 10 Hz Offset		-108		dBc/Hz	
at 100 Hz Offset		-118		dBc/Hz	
at 1 kHz Offset		-128		dBc/Hz	
at 10 kHz Offset		-138		dBc/Hz	
at 100 kHz Offset		-145		dBc/Hz	
at 1 MHz Offset		-148		dBc/Hz	
>10 MHz Offset		-154		dBc/Hz	
CLK1 = 491.52 MHz, OUT = 122.88 MHz Divide Ratio = 4					
at 10 Hz Offset		-118		dBc/Hz	
at 100 Hz Offset		-129		dBc/Hz	
at 1 kHz Offset		-136		dBc/Hz	
at 10 kHz Offset		-147		dBc/Hz	
at 100 kHz Offset		-153		dBc/Hz	
t 1 MHz Offset		-156		dBc/Hz	
>10 MHz Offset		-158		dBc/Hz	
CLK1 = 245.76 MHz, OUT = 245.76 MHz Divide Ratio = 1					
at 10 Hz Offset		-108		dBc/Hz	
at 100 Hz Offset		-118		dBc/Hz	
at 1 kHz Offset		-128		dBc/Hz	
at 10 kHz Offset		-138		dBc/Hz	
at 100 kHz Offset		-145		dBc/Hz	
at 1 MHz Offset		-148		dBc/Hz	
>10 MHz Offset		-155		dBc/Hz	

Parameter	Min	Typ	Max	Unit	Test Conditions/Comments
CLK1 = 245.76 MHz, OUT = 122.88 MHz Divide Ratio = 2					
at 10 Hz Offset		-118		dBc/Hz	
at 100 Hz Offset		-127		dBc/Hz	
at 1 kHz Offset		-137		dBc/Hz	
at 10 kHz Offset		-147		dBc/Hz	
at 100 kHz Offset		-154		dBc/Hz	
at 1 MHz Offset		-156		dBc/Hz	
>10 MHz Offset		-158		dBc/Hz	
CLK1-TO-CMOS ADDITIVE PHASE NOISE					
CLK1 = 245.76 MHz, OUT = 245.76 MHz					
Divide Ratio = 1					
at 10 Hz Offset		-110		dBc/Hz	
at 100 Hz Offset		-121		dBc/Hz	
at 1 kHz Offset		-130		dBc/Hz	
at 10 kHz Offset		-140		dBc/Hz	
at 100 kHz Offset		-145		dBc/Hz	
at 1 MHz Offset		-149		dBc/Hz	
> 10 MHz Offset		-156		dBc/Hz	
CLK1 = 245.76 MHz, OUT = 61.44 MHz					
Divide Ratio = 4					
at 10 Hz Offset		-122		dBc/Hz	
at 100 Hz Offset		-132		dBc/Hz	
at 1 kHz Offset		-143		dBc/Hz	
at 10 kHz Offset		-152		dBc/Hz	
at 100 kHz Offset		-158		dBc/Hz	
at 1 MHz Offset		-160		dBc/Hz	
>10 MHz Offset		-162		dBc/Hz	
CLK1 = 78.6432 MHz, OUT = 78.6432 MHz					
Divide Ratio = 1					
at 10 Hz Offset		-122		dBc/Hz	
at 100 Hz Offset		-132		dBc/Hz	
at 1 kHz Offset		-140		dBc/Hz	
at 10 kHz Offset		-150		dBc/Hz	
at 100 kHz Offset		-155		dBc/Hz	
at 1 MHz Offset		-158		dBc/Hz	
>10 MHz Offset		-160		dBc/Hz	
CLK1 = 78.6432 MHz, OUT = 39.3216 MHz					
Divide Ratio = 2					
at 10 Hz Offset		-128		dBc/Hz	
at 100 Hz Offset		-136		dBc/Hz	
at 1 kHz Offset		-146		dBc/Hz	
at 10 kHz Offset		-155		dBc/Hz	
at 100 kHz Offset		-161		dBc/Hz	
>1 MHz Offset		-162		dBc/Hz	

CLOCK OUTPUT ADDITIVE TIME JITTER

Table 5.

Parameter	Min	Typ	Max	Unit	Test Conditions/Comments
LVPECL OUTPUT ADDITIVE TIME JITTER					
CLK1 = 622.08 MHz Any LVPECL (OUT0 to OUT2) = 622.08 MHz Divide Ratio = 1		40		fs rms	BW = 12 kHz to 20 MHz (OC-12)
CLK1 = 622.08 MHz Any LVPECL (OUT0 to OUT2) = 155.52 MHz Divide Ratio = 4		55		fs rms	BW = 12 kHz to 20 MHz (OC-3)
CLK1 = 400 MHz Any LVPECL (OUT0 to OUT2) = 100 MHz Divide Ratio = 4		215		fs rms	Calculated from SNR of ADC method; $f_c = 100$ MHz with $A_{IN} = 170$ MHz
CLK1 = 400 MHz Any LVPECL (OUT0 to OUT2) = 100 MHz Divide Ratio = 4 Other LVPECL = 100 MHz Both LVDS (OUT3, OUT4) = 100 MHz		215		fs rms	Calculated from SNR of ADC method; $f_c = 100$ MHz with $A_{IN} = 170$ MHz Interferer(s) Interferer(s)
CLK1 = 400 MHz Any LVPECL (OUT0 to OUT2) = 100 MHz Divide Ratio = 4 Other LVPECL = 100 MHz Both LVDS (OUT3, OUT4) = 100 MHz		222		fs rms	Calculated from SNR of ADC method; $f_c = 100$ MHz with $A_{IN} = 170$ MHz Interferer(s) Interferer(s)
CLK1 = 400 MHz Any LVPECL (OUT0 to OUT2) = 100 MHz Divide Ratio = 4 Other LVPECL = 50 MHz Both LVDS (OUT3, OUT4) = 50 MHz		225		fs rms	Calculated from SNR of ADC method; $f_c = 100$ MHz with $A_{IN} = 170$ MHz Interferer(s) Interferer(s)
CLK1 = 400 MHz Any LVPECL (OUT0 to OUT2) = 100 MHz Divide Ratio = 4 Other LVPECL = 50 MHz Both CMOS (OUT3, OUT4) = 50 MHz (B Outputs Off)		225		fs rms	Calculated from SNR of ADC method; $f_c = 100$ MHz with $A_{IN} = 170$ MHz Interferer(s) Interferer(s)
CLK1 = 400 MHz Any LVPECL (OUT0 to OUT2) = 100 MHz Divide Ratio = 4 Other LVPECL = 50 MHz Both CMOS (OUT3, OUT4) = 50 MHz (B Outputs On)		225		fs rms	Calculated from SNR of ADC method; $f_c = 100$ MHz with $A_{IN} = 170$ MHz Interferer(s) Interferer(s)
LVDS OUTPUT ADDITIVE TIME JITTER					
CLK1 = 400 MHz LVDS (OUT3) = 100 MHz Divide Ratio = 4		264		fs rms	Calculated from SNR of ADC method; $f_c = 100$ MHz with $A_{IN} = 170$ MHz
CLK1 = 400 MHz LVDS (OUT4) = 100 MHz Divide Ratio = 4		319		fs rms	Calculated from SNR of ADC method; $f_c = 100$ MHz with $A_{IN} = 170$ MHz
CLK1 = 400 MHz LVDS (OUT3) = 100 MHz Divide Ratio = 4 LVDS (OUT4) = 50 MHz All LVPECL = 50 MHz		395		fs rms	Calculated from SNR of ADC method; $f_c = 100$ MHz with $A_{IN} = 170$ MHz Interferer(s) Interferer(s)

Parameter	Min	Typ	Max	Unit	Test Conditions/Comments
CLK1 = 400 MHz		395		fs rms	Calculated from SNR of ADC method; $f_c = 100$ MHz with $A_{IN} = 170$ MHz
LVDS (OUT4) = 100 MHz Divide Ratio = 4 LVDS (OUT3) = 50 MHz All LVPECL = 50 MHz					Interferer(s) Interferer(s)
CLK1 = 400 MHz		367		fs rms	Calculated from SNR of ADC method; $f_c = 100$ MHz with $A_{IN} = 170$ MHz
LVDS (OUT3) = 100 MHz Divide Ratio = 4 CMOS (OUT4) = 50 MHz (B Outputs Off) All LVPECL = 50 MHz					Interferer(s) Interferer(s)
CLK1 = 400 MHz		367		fs rms	Calculated from SNR of ADC method; $f_c = 100$ MHz with $A_{IN} = 170$ MHz
LVDS (OUT4) = 100 MHz Divide Ratio = 4 CMOS (OUT3) = 50 MHz (B Outputs Off) All LVPECL = 50 MHz					Interferer(s) Interferer(s)
CLK1 = 400 MHz		548		fs rms	Calculated from SNR of ADC method; $f_c = 100$ MHz with $A_{IN} = 170$ MHz
LVDS (OUT3) = 100 MHz Divide Ratio = 4 CMOS (OUT4) = 50 MHz (B Outputs On) All LVPECL = 50 MHz					Interferer(s) Interferer(s)
CLK1 = 400 MHz		548		fs rms	Calculated from SNR of ADC method; $f_c = 100$ MHz with $A_{IN} = 170$ MHz
LVDS (OUT4) = 100 MHz Divide Ratio = 4 CMOS (OUT3) = 50 MHz (B Outputs On) All LVPECL = 50 MHz					Interferer(s) Interferer(s)
CMOS OUTPUT ADDITIVE TIME JITTER					
CLK1 = 400 MHz		275		fs rms	Calculated from SNR of ADC method; $f_c = 100$ MHz with $A_{IN} = 170$ MHz
Both CMOS (OUT3, OUT4) = 100 MHz (B Output On) Divide Ratio = 4					
CLK1 = 400 MHz		400		fs rms	Calculated from SNR of ADC method; $f_c = 100$ MHz with $A_{IN} = 170$ MHz
CMOS (OUT3) = 100 MHz (B Output On) Divide Ratio = 4 All LVPECL = 50 MHz LVDS (OUT4) = 50 MHz					Interferer(s) Interferer(s)
CLK1 = 400 MHz		374		fs rms	Calculated from SNR of ADC method; $f_c = 100$ MHz with $A_{IN} = 170$ MHz
CMOS (OUT3) = 100 MHz (B Output On) Divide Ratio = 4 All LVPECL = 50 MHz CMOS (OUT4) = 50 MHz (B Output Off)					Interferer(s) Interferer(s)
CLK1 = 400 MHz		555		fs rms	Calculated from SNR of ADC method; $f_c = 100$ MHz with $A_{IN} = 170$ MHz
CMOS (OUT3) = 100 MHz (B Output On) Divide Ratio = 4 All LVPECL = 50 MHz CMOS (OUT4) = 50 MHz (B Output On)					Interferer(s) Interferer(s)

SERIAL CONTROL PORT

Table 6.

Parameter	Min	Typ	Max	Unit	Test Conditions/Comments
CSB, SCLK (INPUTS)					CSB and SCLK have 30 k Ω internal pull-down resistors
Input Logic 1 Voltage	2.0			V	
Input Logic 0 Voltage			0.8	V	
Input Logic 1 Current		110		μ A	
Input Logic 0 Current			1	μ A	
Input Capacitance		2		pF	
SDIO (WHEN INPUT)					
Input Logic 1 Voltage	2.0			V	
Input Logic 0 Voltage			0.8	V	
Input Logic 1 Current		10		nA	
Input Logic 0 Current		10		nA	
Input Capacitance		2		pF	
SDIO, SDO (OUTPUTS)					
Output Logic 1 Voltage	2.7			V	
Output Logic 0 Voltage			0.4	V	
TIMING					
Clock Rate (SCLK, 1/t _{SCLK})			25	MHz	
Pulse Width High, t _{PWH}	16			ns	
Pulse Width Low, t _{PWL}	16			ns	
SDIO to SCLK Setup, t _{DS}	2			ns	
SCLK to SDIO Hold, t _{DH}	1			ns	
SCLK to Valid SDIO and SDO, t _{DV}	6			ns	
CSB to SCLK Setup and Hold, t _S , t _H	2			ns	
CSB Minimum Pulse Width High, t _{PWH}	3			ns	

FUNCTION PIN

Table 7.

Parameter	Min	Typ	Max	Unit	Test Conditions/Comments
INPUT CHARACTERISTICS					The FUNCTION pin has a 30 k Ω internal pull-down resistor. This pin is normally held high. Do not let input float.
Logic 1 Voltage	2.0			V	
Logic 0 Voltage			0.8	V	
Logic 1 Current		110		μ A	
Logic 0 Current			1	μ A	
Capacitance		2		pF	
RESET TIMING					
Pulse Width Low	50			ns	
SYNC TIMING					
Pulse Width Low	1.5			High speed clock cycles	High speed clock is CLK1 or CLK2, whichever is being used for distribution.

SYNC STATUS PIN

Table 8.

Parameter	Min	Typ	Max	Unit	Test Conditions/Comments
OUTPUT CHARACTERISTICS					
Output Voltage High (V_{OH})	2.7			V	
Output Voltage Low (V_{OL})			0.4	V	

POWER

Table 9.

Parameter	Min	Typ	Max	Unit	Test Conditions/Comments
POWER-UP DEFAULT MODE POWER DISSIPATION		550	600	mW	Power-up default state; does not include power dissipated in output load resistors. No clock.
POWER DISSIPATION			800	mW	All outputs on. Three LVPECL outputs at 800 MHz, two CMOS out at 62 MHz (5 pF load). Does not include power dissipated in external resistors.
			850	mW	All outputs on. Three LVPECL outputs at 800 MHz, two CMOS out at 125 MHz (5 pF load). Does not include power dissipated in external resistors.
Full Sleep Power-Down		35	60	mW	Maximum sleep is entered by setting 0x0A[1:0] = 01b and 0x58[4] = 1b. This powers off all band gap references. Does not include power dissipated in terminations.
Power-Down (PDB)		60	80	mW	Set FUNCTION pin for PDB operation by setting 0x58[6:5] = 11b. Pull PDB low. Does not include power dissipated in terminations.
POWER DELTA					
CLK1, CLK2 Power-Down	10	15	25	mW	
Divider, DIV 2 to 32 to Bypass	23	27	33	mW	For each divider.
LVPECL Output Power-Down (PD2, PD3)	50	65	75	mW	For each output. Does not include dissipation in termination (PD2 only).
LVDS Output Power-Down	80	92	110	mW	For each output.
CMOS Output Power-Down (Static)	56	70	85	mW	For each output. Static (no clock).
CMOS Output Power-Down (Dynamic)	115	150	190	mW	For each CMOS output, single-ended. Clocking at 62 MHz with 5 pF load.
CMOS Output Power-Down (Dynamic)	125	165	210	mW	For each CMOS output, single-ended. Clocking at 125 MHz with 5 pF load.

ABSOLUTE MAXIMUM RATINGS

Table 10.

Parameter	With Respect to	Rating
VS	GND	−0.3 V to +3.6 V
DSYNC/DSYNCB	GND	−0.3 V to $V_S + 0.3$ V
RSET	GND	−0.3 V to $V_S + 0.3$ V
CLK1, CLK1B, CLK2, CLK2B	GND	−0.3 V to $V_S + 0.3$ V
CLK1	CLK1B	−1.2 V to +1.2 V
CLK2	CLK2B	−1.2 V to +1.2 V
SCLK, SDIO, SDO, CSB	GND	−0.3 V to $V_S + 0.3$ V
OUT0, OUT1, OUT2, OUT3, OUT4	GND	−0.3 V to $V_S + 0.3$ V
FUNCTION	GND	−0.3 V to $V_S + 0.3$ V
SYNC STATUS	GND	−0.3 V to $V_S + 0.3$ V
Junction Temperature		150°C
Storage Temperature Range		−65°C to +150°C
Lead Temperature (10 sec)		300°C

Stresses at or above those listed under Absolute Maximum Ratings may cause permanent damage to the product. This is a stress rating only; functional operation of the product at these or any other conditions above those indicated in the operational section of this specification is not implied. Operation beyond the maximum operating conditions for extended periods may affect product reliability.

THERMAL RESISTANCE

Table 11. Thermal Resistance¹

Package Type	θ_{JA}	Unit
CP-48-13	28.5	°C/W

¹ Thermal impedance measurements were taken on a 4-layer board in still air, in accordance with EIA/JESD51-7.

ESD CAUTION



ESD (electrostatic discharge) sensitive device. Charged devices and circuit boards can discharge without detection. Although this product features patented or proprietary protection circuitry, damage may occur on devices subjected to high energy ESD. Therefore, proper ESD precautions should be taken to avoid performance degradation or loss of functionality.

PIN CONFIGURATION AND FUNCTION DESCRIPTIONS

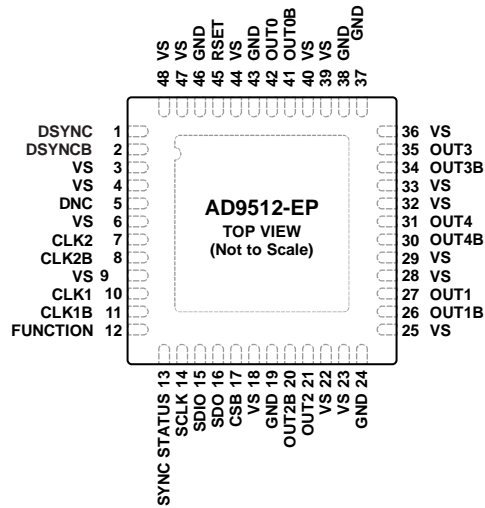

NOTES

1. DNC = DO NOT CONNECT TO THIS PIN.
2. THE EXPOSED PADDLE ON THIS PACKAGE IS AN ELECTRICAL CONNECTION AS WELL AS A THERMAL ENHANCEMENT. FOR THE DEVICE TO FUNCTION PROPERLY, THE PADDLE MUST BE ATTACHED TO GROUND, GND.

10463-002

Figure 2. Pin Configuration

Table 12. Pin Function Descriptions

Pin No.	Mnemonic	Description
1	DSYNC	Detect Sync. Used for multichip synchronization.
2	DSYNCB	Detect Sync Complement. Used for multichip synchronization.
3, 4, 6, 9, 18, 22, 23, 25, 28, 29, 32, 33, 36, 39, 40, 44, 47, 48	VS	Power Supply (3.3 V).
5	DNC	Do Not Connect. Do not connect to this pin.
7	CLK2	Clock Input.
8	CLK2B	Complementary Clock Input. Used in conjunction with CLK2.
10	CLK1	Clock Input.
11	CLK1B	Complementary Clock Input. Used in conjunction with CLK1.
12	FUNCTION	Multipurpose Input. Can be programmed as a reset (RESETB), sync (SYNCB), or power-down (PDB) pin.
13	SYNC STATUS	Output Used to Monitor the Status of Multichip Synchronization.
14	SCLK	Serial Data Clock.
15	SDIO	Serial Data I/O.
16	SDO	Serial Data Output.
17	CSB	Serial Port Chip Select.
19, 24, 37, 38, 43, 46	GND	Ground.
20	OUT2B	Complementary LVPECL Output.
21	OUT2	LVPECL Output.
26	OUT1B	Complementary LVPECL Output.
27	OUT1	LVPECL Output.
30	OUT4B	Complementary LVDS/Inverted CMOS Output.
31	OUT4	LVDS/CMOS Output.
34	OUT3B	Complementary LVDS/Inverted CMOS Output.

Pin No.	Mnemonic	Description
35	OUT3	LVDS/CMOS Output.
41	OUT0B	Complementary LVPECL Output.
42	OUT0	LVPECL Output.
45	RSET	Current Set Resistor to Ground. Nominal value = 4.12 k Ω .
	EPAD	Exposed paddle. The exposed paddle on this package is an electrical connection as well as a thermal enhancement. For the device to function properly, the paddle must be attached to ground, GND.

TYPICAL PERFORMANCE CHARACTERISTICS

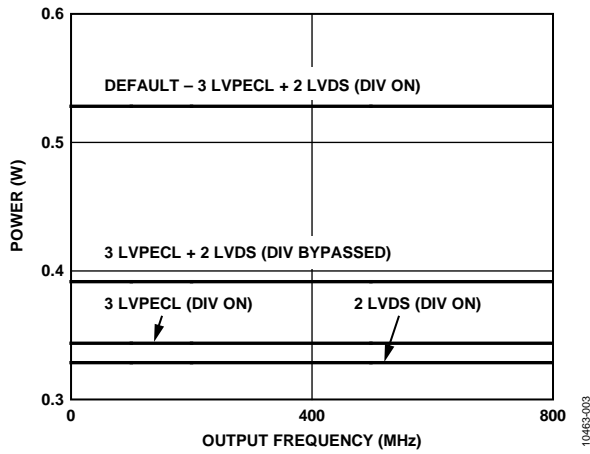

Figure 3. Power vs. Frequency—LVPECL, LVDS

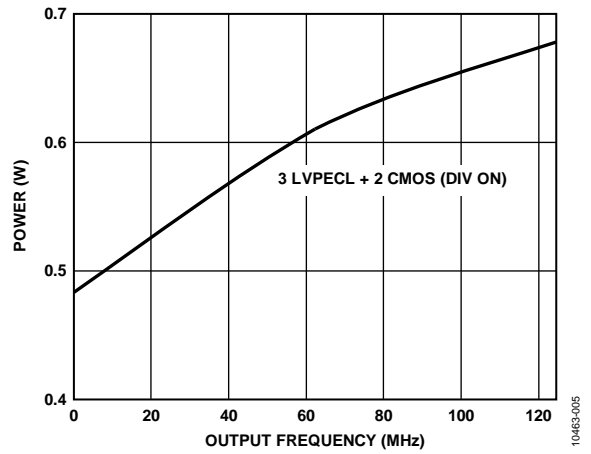

Figure 5. Power vs. Frequency—LVPECL, CMOS

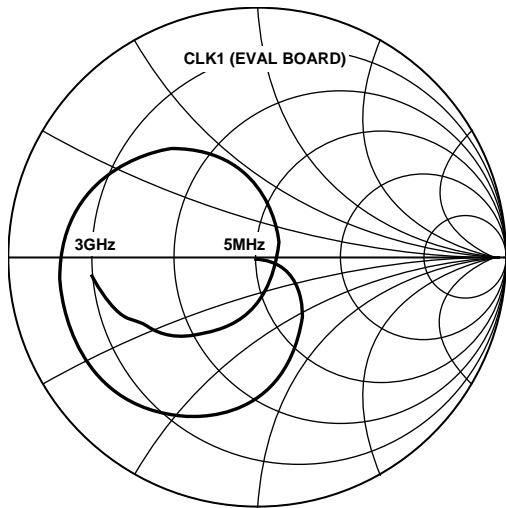

Figure 4. CLK1 Smith Chart (Evaluation Board)

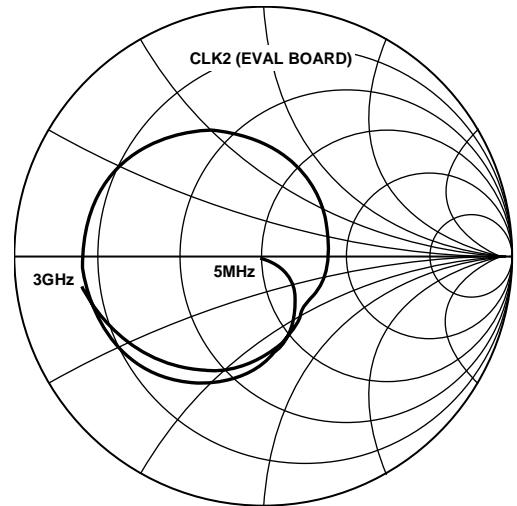

Figure 6. CLK2 Smith Chart (Evaluation Board)

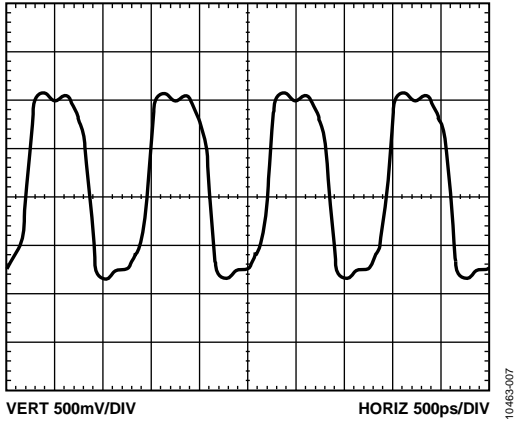

Figure 7. LVPECL Differential Output at 800 MHz

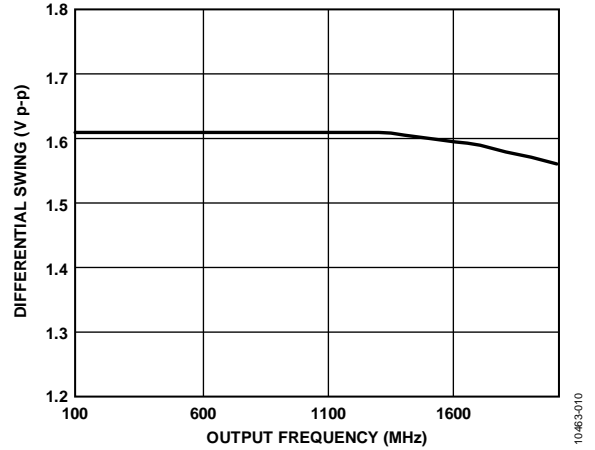

Figure 10. LVPECL Differential Output Swing vs. Frequency

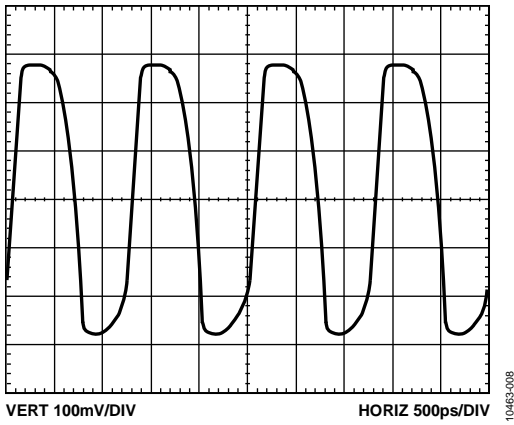

Figure 8. LVDS Differential Output at 800 MHz

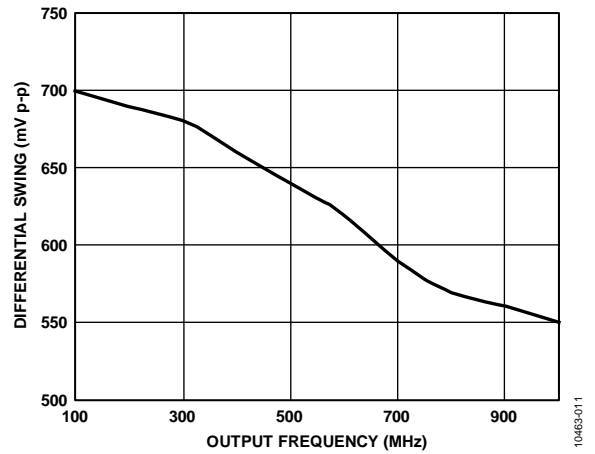

Figure 11. LVDS Differential Output Swing vs. Frequency

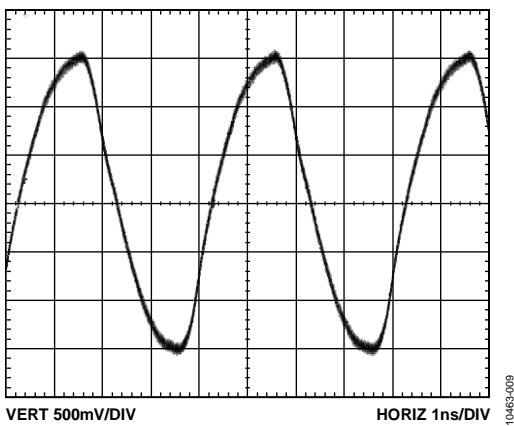

Figure 9. CMOS Single-Ended Output at 250 MHz with 10 pF Load

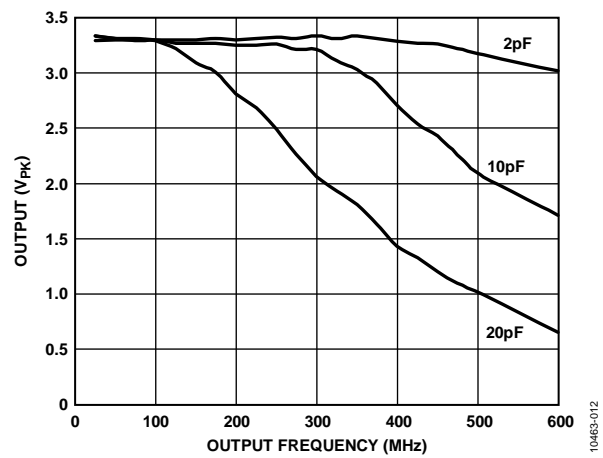

Figure 12. CMOS Single-Ended Output Swing vs. Frequency and Load

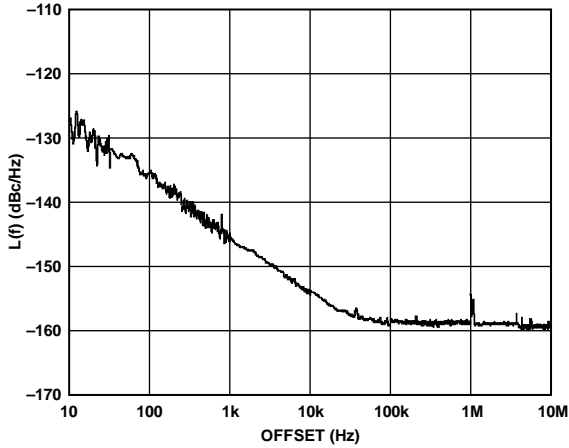

Figure 13. Additive Phase Noise—LVPECL DIV1, 245.76 MHz Distribution Section Only

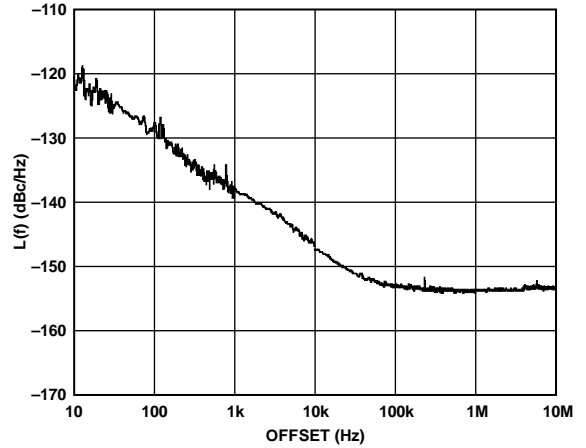

Figure 16. Additive Phase Noise—LVPECL DIV1, 622.08 MHz

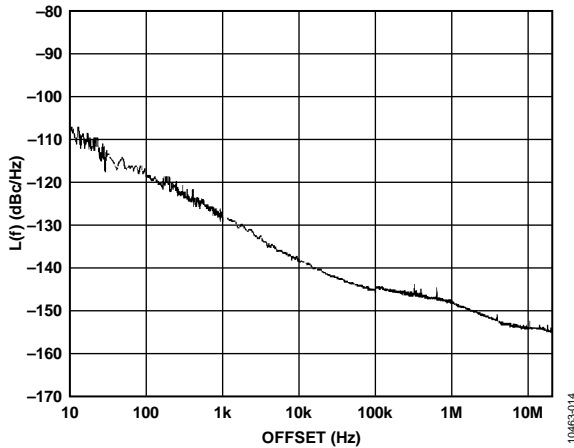

Figure 14. Additive Phase Noise—LVDS DIV1, 245.76 MHz

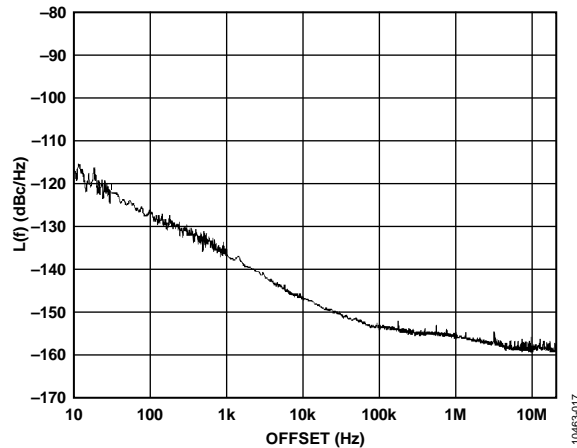

Figure 17. Additive Phase Noise—LVDS DIV2, 122.88 MHz

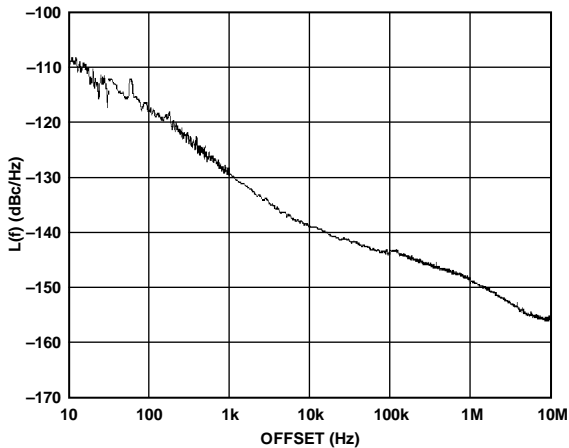

Figure 15. Additive Phase Noise—CMOS DIV1, 245.76 MHz

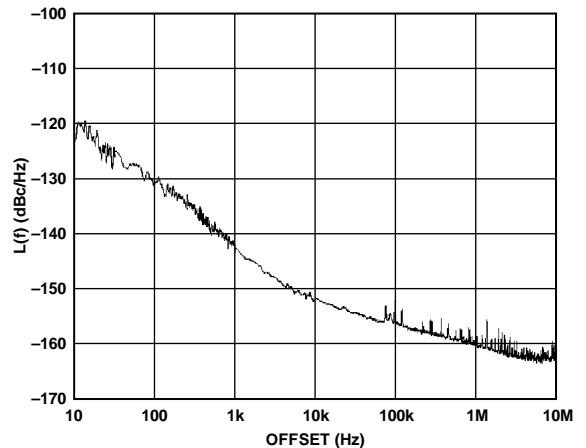

Figure 18. Additive Phase Noise—CMOS DIV4, 61.44 MHz

OUTLINE DIMENSIONS

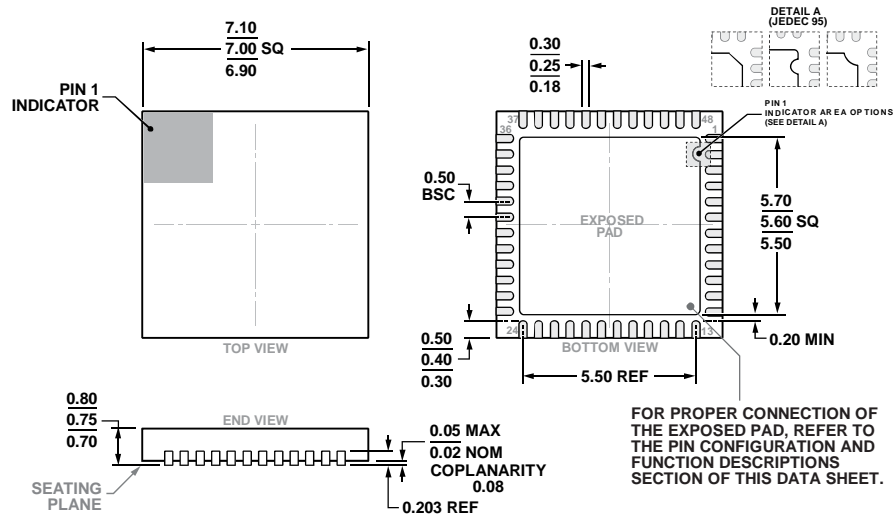

Figure 19. 48-Lead Lead Frame Chip Scale Package [LFCSP]
7 mm x 7 mm Body and 0.75 mm Package Height
(CP-48-13)
Dimensions shown in millimeters

ORDERING GUIDE

Model ¹	Temperature Range	Package Description	Package Option
AD9512UCPZ-EP	-55°C to +85°C	48-Lead Lead Frame Chip Scale Package [LFCSP]	CP-48-13
AD9512UCPZ-EP-R7	-55°C to +85°C	48-Lead Lead Frame Chip Scale Package [LFCSP]	CP-48-13

¹ Z = RoHS Compliant Part.