

Surface Mount Trench MOS Barrier Schottky Rectifier


DO-214AB (SMC)

PRIMARY CHARACTERISTICS	
$I_{F(AV)}$	5.0 A
V_{RRM}	200 V
I_{FSM}	100 A
V_F at $I_F = 5.0$ A	0.67 V
T_J max.	150 °C
Package	DO-214AB (SMC)
Diode variation	Single die

FEATURES

- Low profile package
- Ideal for automated placement
- Trench MOS Schottky technology
- Low power losses, high efficiency
- Low forward voltage drop
- Meets MSL level 1, per J-STD-020, LF maximum peak of 260 °C
- Material categorization: For definitions of compliance please see www.vishay.com/doc?99912



RoHS
COMPLIANT
HALOGEN
FREE

TYPICAL APPLICATIONS

For use in high frequency converters, freewheeling diodes, DC/DC converters and polarity protection applications.

MECHANICAL DATA

Case: DO-214AB (SMC)

Molding compound meets UL 94 V-0 flammability rating Base P/N-M3 - halogen-free and RoHS-compliant, commercial grade

Terminals: Matte tin plated leads, solderable per J-STD-002 and JESD 22-B102

M3 suffix meets JESD 201 class 2 whisker test

Polarity: Color band denotes the cathode end

MAXIMUM RATINGS ($T_A = 25$ °C unless otherwise noted)			
PARAMETER	SYMBOL	VSSC520S	UNIT
Device marking code		V5D	
Maximum repetitive peak reverse voltage	V_{RRM}	200	V
Maximum DC forward current	$I_F^{(1)}$	5.0	A
	$I_F^{(2)}$	2.2	
Peak forward surge current 10 ms single half sine-wave superimposed on rated load	I_{FSM}	100	A
Voltage rate of change (rated V_R)	dV/dt	10 000	V/ μ s
Operating junction and storage temperature range	T_J, T_{STG}	-40 to +150	°C

Notes

(1) Units mounted on PCB with 25 mm x 25 mm copper pad areas, 1 oz. FR4 PCB

(2) Free air, mounted on recommended PCB 1 oz. pad area

ELECTRICAL CHARACTERISTICS ($T_A = 25\text{ }^\circ\text{C}$ unless otherwise noted)						
PARAMETER	TEST CONDITIONS		SYMBOL	TYP.	MAX.	UNIT
Instantaneous forward voltage	$I_F = 5.0\text{ A}$	$T_A = 25\text{ }^\circ\text{C}$	$V_F^{(1)}$	1.19	1.70	V
		$T_A = 125\text{ }^\circ\text{C}$		0.67	0.75	
Reverse current per diode	$V_R = 180\text{ V}$	$T_A = 25\text{ }^\circ\text{C}$	$I_R^{(2)}$	2.0	-	μA
		$T_A = 125\text{ }^\circ\text{C}$		2.0	-	mA
	$V_R = 200\text{ V}$	$T_A = 25\text{ }^\circ\text{C}$		4	200	μA
		$T_A = 125\text{ }^\circ\text{C}$		3.2	25	mA
Typical junction capacitance	4.0 V, 1 MHz		C_J	280	-	pF

Notes

- (1) Pulse test: 300 μs pulse width, 1 % duty cycle
 (2) Pulse test: Pulse width $\leq 40\text{ ms}$

THERMAL CHARACTERISTICS ($T_A = 25\text{ }^\circ\text{C}$ unless otherwise noted)			
PARAMETER	SYMBOL	VSSC520S	UNIT
Typical thermal resistance	$R_{\theta JA}^{(1)}$	95	$^\circ\text{C/W}$
	$R_{\theta JM}^{(2)}$	9	

Notes

- (1) Free air, mounted on recommended PCB 1 oz. pad area; thermal resistance $R_{\theta JA}$ - junction to ambient
 (2) Units mounted on PCB with 25 mm x 25 mm copper pad areas; thermal resistance $R_{\theta JM}$ - junction to mount

ORDERING INFORMATION (Example)				
PREFERRED P/N	UNIT WEIGHT (g)	PREFERRED PACKAGE CODE	BASE QUANTITY	DELIVERY MODE
VSSC520S-M3/57T	0.235	57T	850	7" diameter plastic tape and reel
VSSC520S-M3/9AT	0.235	9AT	3500	13" diameter plastic tape and reel

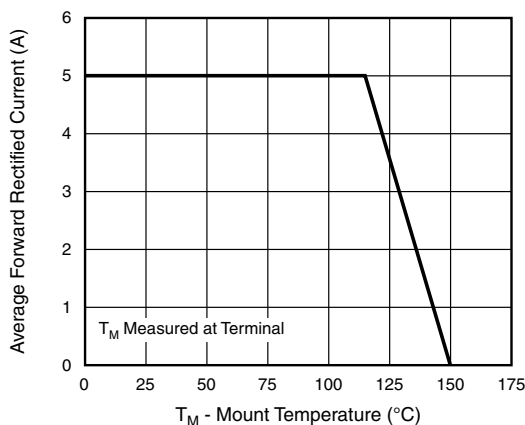
RATINGS AND CHARACTERISTICS CURVES ($T_A = 25\text{ }^\circ\text{C}$ unless otherwise noted)


Fig. 1 - Maximum Forward Current Derating Curve

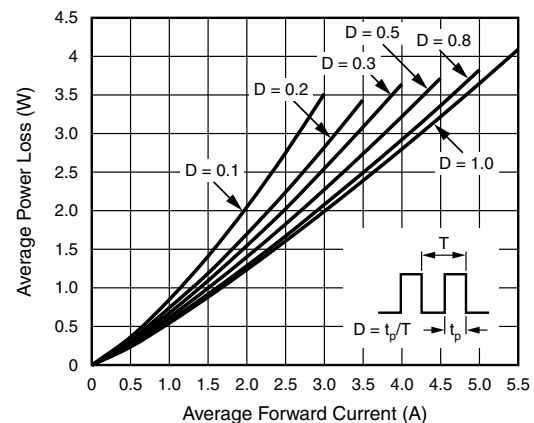


Fig. 2 - Forward Power Loss Characteristics

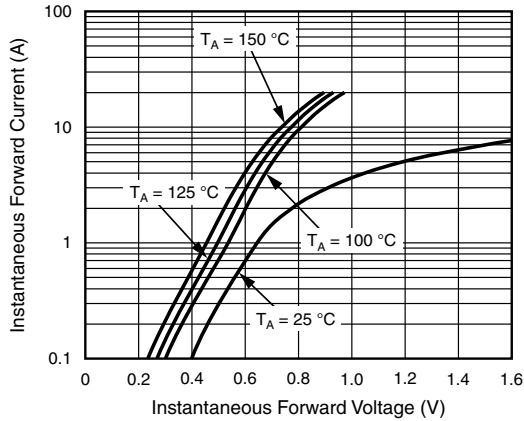


Fig. 3 - Typical Instantaneous Forward Characteristics

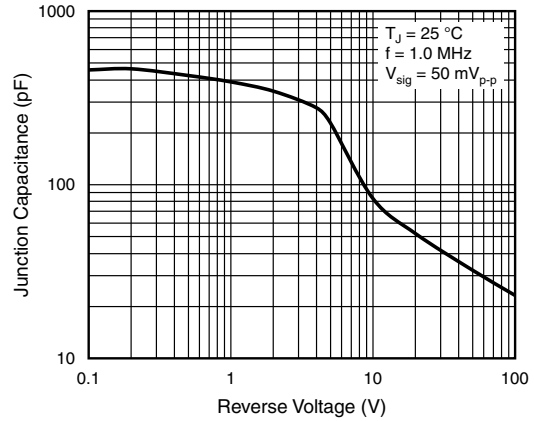


Fig. 5 - Typical Junction Capacitance

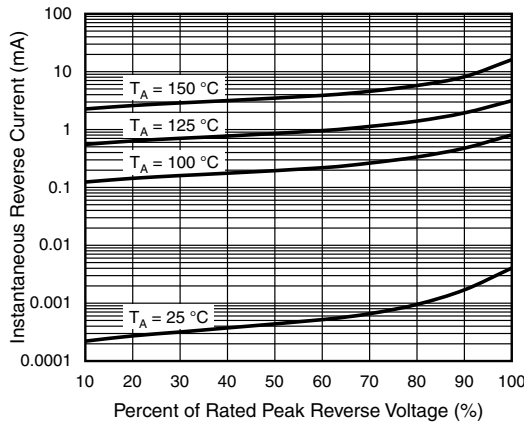


Fig. 4 - Typical Reverse Characteristics

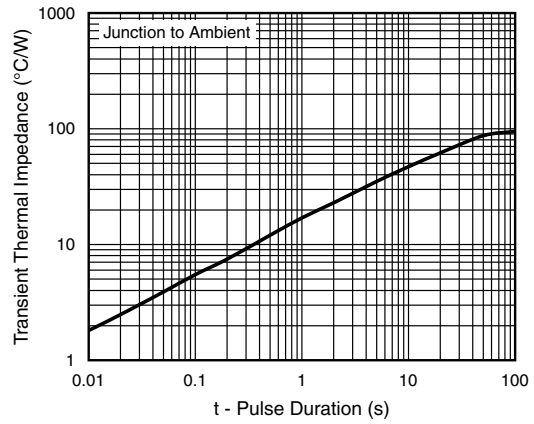
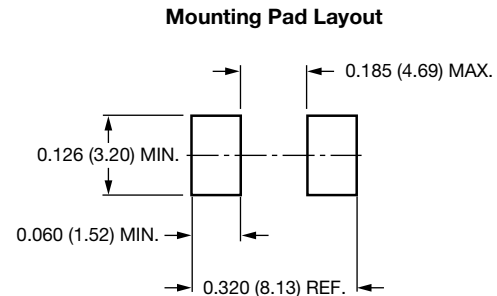
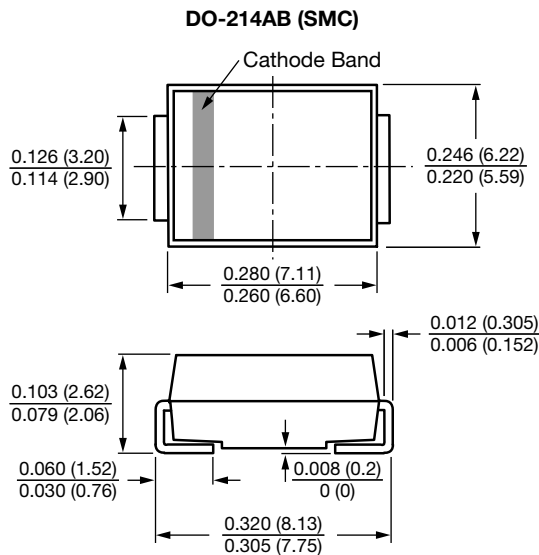


Fig. 6 - Typical Transient Thermal Impedance

PACKAGE OUTLINE DIMENSIONS in inches (millimeters)





Disclaimer

ALL PRODUCT, PRODUCT SPECIFICATIONS AND DATA ARE SUBJECT TO CHANGE WITHOUT NOTICE TO IMPROVE RELIABILITY, FUNCTION OR DESIGN OR OTHERWISE.

Vishay Intertechnology, Inc., its affiliates, agents, and employees, and all persons acting on its or their behalf (collectively, "Vishay"), disclaim any and all liability for any errors, inaccuracies or incompleteness contained in any datasheet or in any other disclosure relating to any product.

Vishay makes no warranty, representation or guarantee regarding the suitability of the products for any particular purpose or the continuing production of any product. To the maximum extent permitted by applicable law, Vishay disclaims (i) any and all liability arising out of the application or use of any product, (ii) any and all liability, including without limitation special, consequential or incidental damages, and (iii) any and all implied warranties, including warranties of fitness for particular purpose, non-infringement and merchantability.

Statements regarding the suitability of products for certain types of applications are based on Vishay's knowledge of typical requirements that are often placed on Vishay products in generic applications. Such statements are not binding statements about the suitability of products for a particular application. It is the customer's responsibility to validate that a particular product with the properties described in the product specification is suitable for use in a particular application. Parameters provided in datasheets and / or specifications may vary in different applications and performance may vary over time. All operating parameters, including typical parameters, must be validated for each customer application by the customer's technical experts. Product specifications do not expand or otherwise modify Vishay's terms and conditions of purchase, including but not limited to the warranty expressed therein.

Except as expressly indicated in writing, Vishay products are not designed for use in medical, life-saving, or life-sustaining applications or for any other application in which the failure of the Vishay product could result in personal injury or death. Customers using or selling Vishay products not expressly indicated for use in such applications do so at their own risk. Please contact authorized Vishay personnel to obtain written terms and conditions regarding products designed for such applications.

No license, express or implied, by estoppel or otherwise, to any intellectual property rights is granted by this document or by any conduct of Vishay. Product names and markings noted herein may be trademarks of their respective owners.

Mouser Electronics

Authorized Distributor

Click to View Pricing, Inventory, Delivery & Lifecycle Information:

Vishay:

[VSSC520S-M3/57T](#) [VSSC520S-M3/9AT](#)