

120×120×38 mm

San Ace 120 9G type   



General Specifications

- Material Frame: Plastic (Flammability: UL 94V-0), Impeller: Plastic (Flammability: UL 94V-1)
- Expected life See the table below. (L10 life: 90% survival rate for continuous operation in free air at 60°C, rated voltage)
- Motor protection function Locked rotor burnout protection, Reverse polarity protection
For details, please refer to p. 529.
- Dielectric strength 50/60 Hz, 500 VAC, for 1 minute (between lead wire conductors and frame)
- Insulation resistance 10 MΩ or more with a 500 VDC megger (between lead wire conductors and frame)
- Sound pressure level (SPL) At 1 m away from the air inlet
- Storage temperature -30 to +70°C (Non-condensing)
- Lead wire ⊕Red ⊖Black or Blue (Sensor) Yellow
- Mass 330 g

Specifications

The models listed below **have ribs and pulse sensors**. For models without ribs, append "1" to the end of model numbers.

Model no.	Rated voltage [V]	Operating voltage range [V]	Rated current [A]	Rated input [W]	Rated speed [min ⁻¹]	Max. airflow [m ³ /min] [CFM]	Max. static pressure [Pa] [inchH ₂ O]	SPL [dB (A)]	Operating temperature [°C]	Expected life [h]
9G1212G101	12	10.2 to 13.8	0.98	11.76	3600	3.88 137	135 0.542	49	-20 to +70	40000/60°C
9G1212E101			0.61	7.32	3100	3.34 118	100 0.402	46		
9G1212H101		7 to 13.8	0.38	4.56	2600	2.8 99	70.4 0.283	39		
9G1212F101			0.28	3.36	2280	2.45 87	54.2 0.218	36		
9G1212M101			0.21	2.52	1950	2.1 74	39.6 0.159	32		
9G1224G101	24	20.4 to 27.6	0.5	12	3600	3.88 137	135 0.542	49		
9G1224E101			0.34	8.16	3100	3.34 118	100 0.402	46		
9G1224H101		14 to 27.6	0.22	5.28	2600	2.8 99	70.4 0.283	39		
9G1224F101			0.16	3.84	2280	2.45 87	54.2 0.218	36		
9G1224M101			0.11	2.64	1950	2.1 74	39.6 0.159	32		
9G1248G101	48	40.8 to 55.2	0.25	12	3600	3.88 137	135 0.542	49		
9G1248E101			0.17	8.16	3100	3.34 118	100 0.402	46		
9G1248H101			0.11	5.28	2600	2.8 99	70.4 0.283	39		
9G1248F101			0.09	4.32	2280	2.45 87	54.2 0.218	36		
9G1248M101			0.07	3.36	1950	2.1 74	39.6 0.159	32		

Other sensor specifications are available as options. Refer to the index (pp. 549 to 550).

Airflow - Static Pressure Characteristics

9G1212G101 With pulse sensor

Operating voltage range

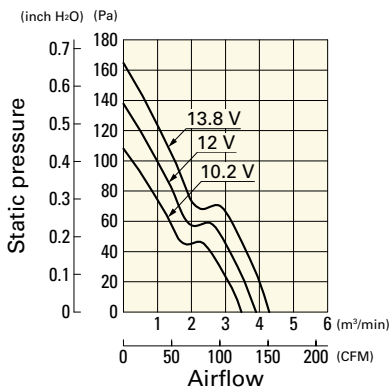

9G1212E101 With pulse sensor

Operating voltage range

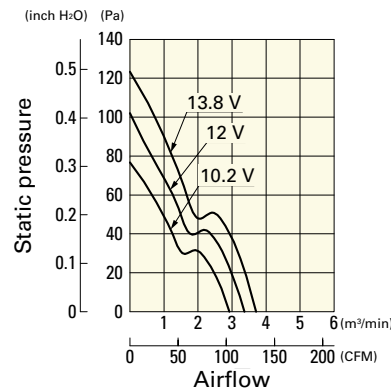

9G1212H101 With pulse sensor

Operating voltage range

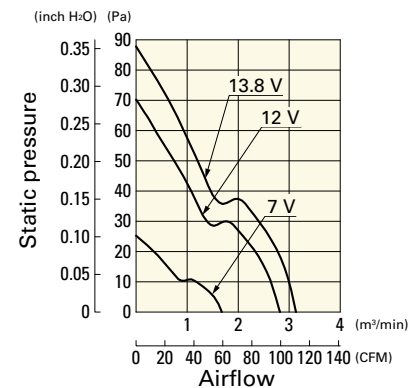

Airflow - Static Pressure Characteristics

9G1212F101 With pulse sensor

Operating voltage range

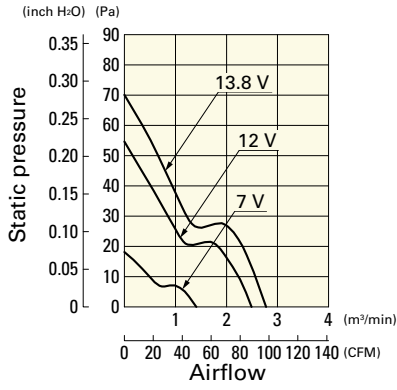

9G1212M101 With pulse sensor

Operating voltage range

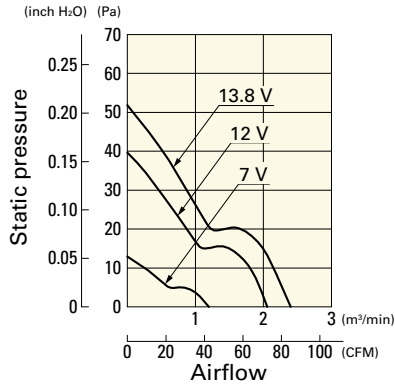

9G1224G101 With pulse sensor

Operating voltage range

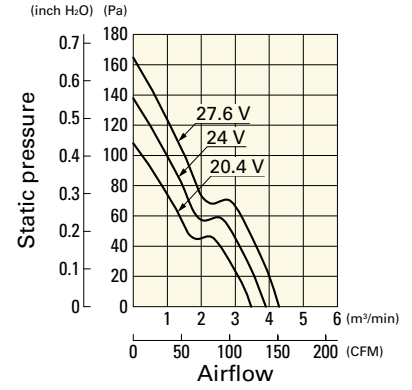

9G1224E101 With pulse sensor

Operating voltage range

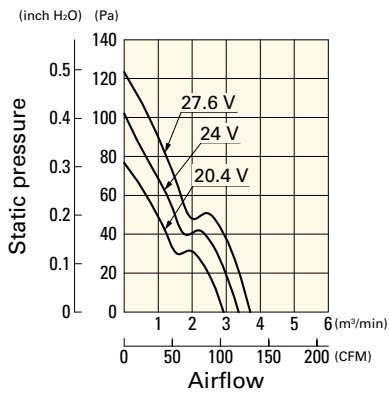

9G1224H101 With pulse sensor

Operating voltage range

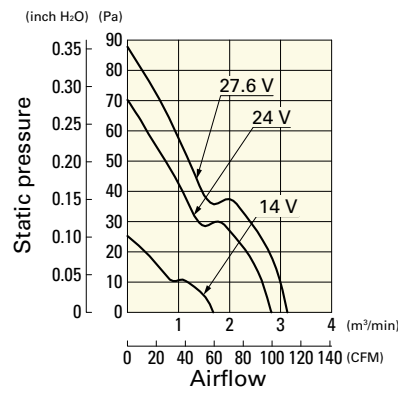

9G1224F101 With pulse sensor

Operating voltage range

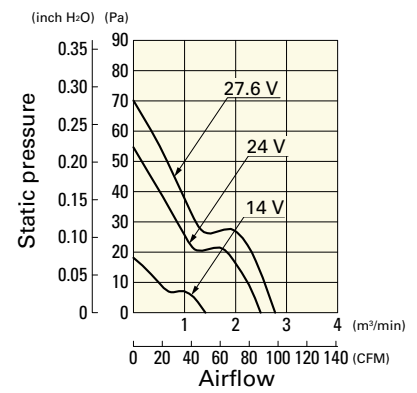

9G1224M101 With pulse sensor

Operating voltage range

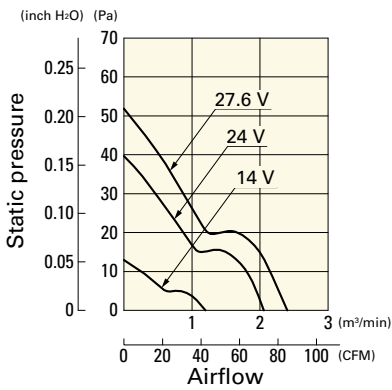

9G1248G101 With pulse sensor

Operating voltage range

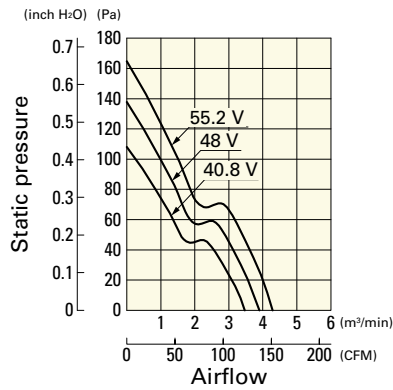

9G1248E101 With pulse sensor

Operating voltage range

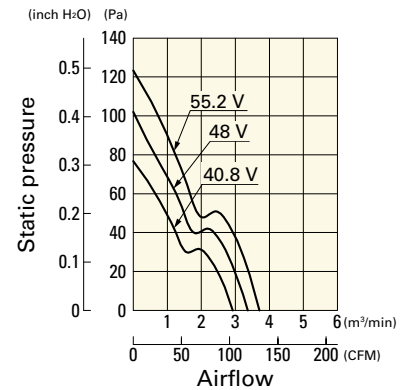

9G1248H101 With pulse sensor

Operating voltage range

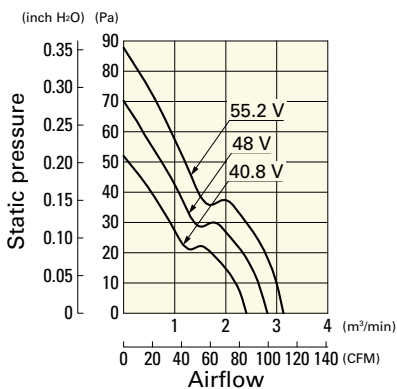

9G1248F101 With pulse sensor

Operating voltage range

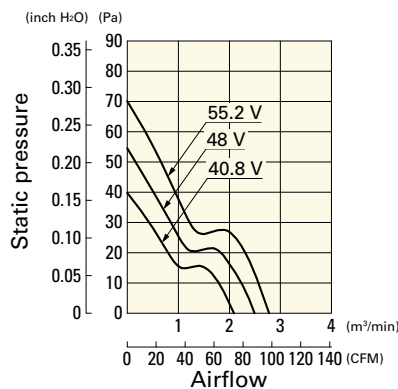

9G1248M101 With pulse sensor

Operating voltage range

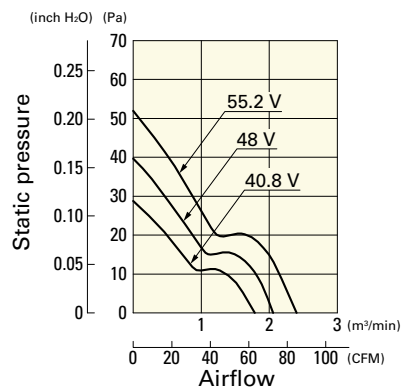

Dimensions (unit: mm) (With ribs)

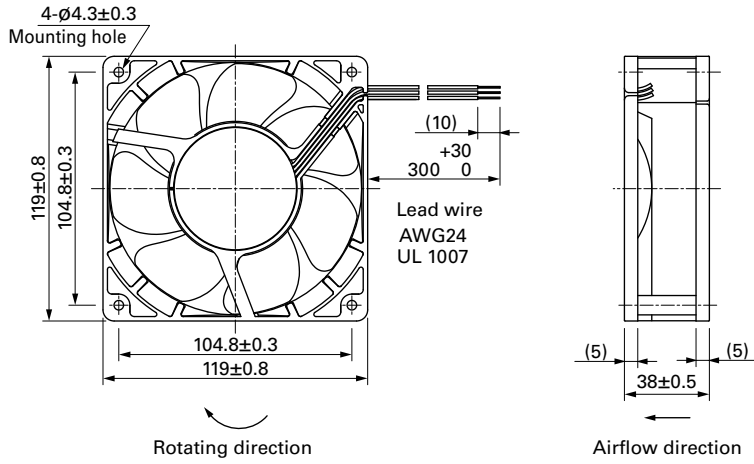

Reference Dimensions of Mounting Holes and Vent Opening (unit: mm)

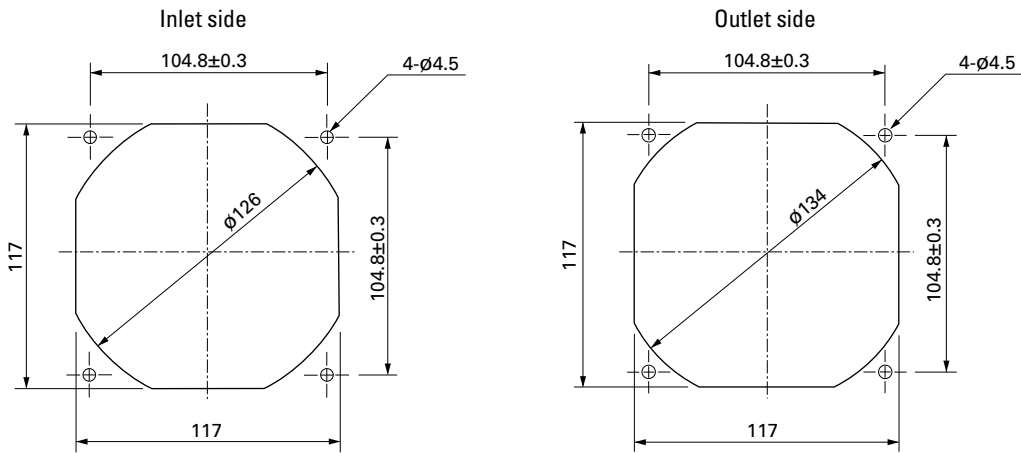

Options

Finger guards

page: p. 514

Model no.: 109-019C, 109-019H, 109-019E, 109-019K

Resin finger guards

page: p. 520

Model no.: 109-1000G

Resin filter kits

page: p. 521

Model no.: 109-1000F13 (13PPI), 109-1000F20 (20PPI),
109-1000F30 (30PPI), 109-1000F40 (40PPI)

Mouser Electronics

Authorized Distributor

Click to View Pricing, Inventory, Delivery & Lifecycle Information:

Sanyo Denki:

[9G1212M101](#) [9G1212M1011](#) [9G1224G1011](#) [9G1224H101](#) [9G1248H101](#) [9G1212F102](#) [9G1212H102](#)
[9G1224E102](#) [9G1224E1021](#) [9G1224H102](#) [9G1224M1021](#) [9G1212H1011](#) [9G1224G101](#) [9G1224M1011](#)
[9G1248H1011](#) [9G1212M1021](#) [9G1212F101](#) [9G1248E1011](#) [9G1248E102](#) [9G1212G101](#) [9G1248F101](#) [9G1212E102](#)
[9G1212E101](#) [9G1212E1011](#) [9G1224E101](#) [9G1212E1021](#) [9G1224F102](#) [9G1212M102](#) [9G1248E101](#) [9G1224M101](#)
[9G1224M102](#) [9G1248E1021](#) [9G1224E1011](#) [9G1224G1021](#) [9G1224F101](#) [9G1224G102](#) [9G1248G101](#)
[9G1212G1021](#) [9G1248G1011](#) [9G1212H101](#) [9G1224H1D01](#) [9G1212G1011](#) [9G1224F1011](#) [9G1248F1011](#)
[9G1248M1011](#) [9G1212F1011](#) [9G1248M101](#) [9G1224H1011](#) [9G1212E1D011](#) [9G1212E1D01](#) [9G1212H1021](#)
[9G1224M1D01](#) [9G1248F1021](#) [9G1248F1D01](#) [9G1224E1D011](#) [9G1248H1D01](#) [9G1248G102](#) [9G1248M1021](#)
[9G1248G1021](#) [9G1248M1D01](#) [9G1212G1D01](#) [9G1248H1D011](#) [9G1224H1021](#) [9G1248M102](#) [9G1212M1D011](#)
[9G1248G1D011](#) [9G1224G1D01](#) [9G1224G1D011](#) [9G1248H1021](#) [9G1212G102](#) [9G1212H1D01](#) [9G1224E1D01](#)
[9G1248E1D01](#) [9G1248F102](#) [9G1248G1D01](#) [9G1212F1021](#) [9G1224F1021](#) [9G1224F1D01](#) [9G1212M1D01](#)
[9G1224M1D011](#) [9G1212G1D011](#) [9G1212H1D011](#) [9G1248H102](#) [9G1248E1D011](#) [9G1224P1G01](#) [9G1248P1G041](#)
[9G1224EG101](#) [9G1212P1G04](#) [9G1212P1G081](#) [9G1248P1G04](#)