

**Polar™ HiPerFET™**  
**Power MOSFETs**

**IXFK26N120P**  
**IXFX26N120P**

**V<sub>DSS</sub> = 1200V**  
**I<sub>D25</sub> = 26A**  
**R<sub>DS(on)</sub> ≤ 500mΩ**  
**t<sub>rr</sub> ≤ 300ns**

N-Channel Enhancement Mode  
Avalanche Rated  
Fast Intrinsic Diode

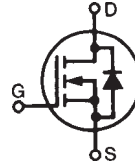

Symbol	Test Conditions	Maximum Ratings	
V <sub>DSS</sub>	T <sub>J</sub> = 25°C to 150°C	1200	V
V <sub>DGR</sub>	T <sub>J</sub> = 25°C to 150°C, R <sub>GS</sub> = 1MΩ	1200	V
V <sub>GSS</sub>	Continuous	± 30	V
V <sub>GSM</sub>	Transient	± 40	V
I <sub>D25</sub>	T <sub>C</sub> = 25°C	26	A
I <sub>DM</sub>	T <sub>C</sub> = 25°C, Pulse Width Limited by T <sub>JM</sub>	60	A
I <sub>A</sub>	T <sub>C</sub> = 25°C	13	A
E <sub>AS</sub>	T <sub>C</sub> = 25°C	1.5	J
P <sub>D</sub>	T <sub>C</sub> = 25°C	960	W
dv/dt	I <sub>S</sub> ≤ I <sub>DM</sub> , V <sub>DD</sub> ≤ V <sub>DSS</sub> , T <sub>J</sub> ≤ 150°C	20	V/ns
T <sub>J</sub>		-55 ... +150	°C
T <sub>JM</sub>		150	°C
T <sub>stg</sub>		-55 ... +150	°C
T <sub>L</sub>	1.6mm (0.062 in.) from Case for 10s	300	°C
T <sub>SOLD</sub>	Plastic Body for 10s	260	°C
M <sub>d</sub>	Mounting Torque (TO-264)	1.13/10	Nm/lb.in.
F <sub>c</sub>	Mounting Force (PLUS247)	20..120 / 4.5..27	N/lb.
Weight	TO-264	10	g
	PLUS247	6	g

TO-264 (IXFK)

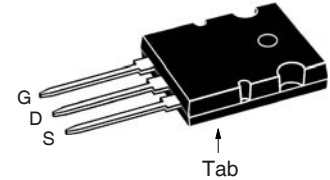

PLUS247 (IXFX)

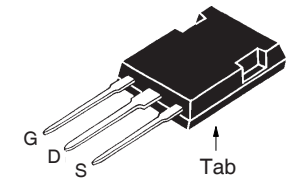

G = Gate      D = Drain  
S = Source      Tab = Drain

**Features**

- Fast Intrinsic Diode
- Dynamic dv/dt Rating
- Avalanche Rated
- Low R<sub>DS(ON)</sub> and Q<sub>G</sub>
- Low Package Inductance

**Advantages**

- High Power Density
- Easy to Mount
- Space Savings

**Applications**

- Switch-Mode and Resonant-Mode Power Supplies
- DC-DC Converters
- Discharger Circuits in Lesers Pulsers, Spark Igniters, RF Generators
- High Voltage Pulse Power Supplies
- AC and DC Motor Drives
- High Speed Power Switching Application

Symbol	Test Conditions (T <sub>J</sub> = 25°C Unless Otherwise Specified)	Characteristic Values		
		Min.	Typ.	Max.
BV <sub>DSS</sub>	V <sub>GS</sub> = 0V, I <sub>D</sub> = 3mA	1200		V
V <sub>GS(th)</sub>	V <sub>DS</sub> = V <sub>GS</sub> , I <sub>D</sub> = 1mA	3.5		6.5 V
I <sub>GSS</sub>	V <sub>GS</sub> = ± 30V, V <sub>DS</sub> = 0V			± 200 nA
I <sub>DSS</sub>	V <sub>DS</sub> = V <sub>DSS</sub> , V <sub>GS</sub> = 0V T <sub>J</sub> = 125°C			50 μA 5 mA
R <sub>DS(on)</sub>	V <sub>GS</sub> = 10V, I <sub>D</sub> = 0.5 • I <sub>D25</sub> , Note 1			500 mΩ

Symbol	Test Conditions ( $T_J = 25^\circ\text{C}$ Unless Otherwise Specified)	Characteristic Values		
		Min.	Typ.	Max.
$g_{fs}$	$V_{DS} = 20\text{V}$ , $I_D = 0.5 \cdot I_{D25}$ , Note 1	13	21	S
$C_{iss}$	$V_{GS} = 0\text{V}$ , $V_{DS} = 25\text{V}$ , $f = 1\text{MHz}$		14	nF
$C_{oss}$			725	pF
$C_{rss}$			50	pF
$R_{Gi}$	Gate Input Resistance		1.5	$\Omega$
$t_{d(on)}$	<b>Resistive Switching Times</b> $V_{GS} = 10\text{V}$ , $V_{DS} = 0.5 \cdot V_{DSS}$ , $I_D = 0.5 \cdot I_{D25}$ $R_G = 1\Omega$ (External)		56	ns
$t_r$			55	ns
$t_{d(off)}$			76	ns
$t_f$			58	ns
$Q_{g(on)}$	$V_{GS} = 10\text{V}$ , $V_{DS} = 0.5 \cdot V_{DSS}$ , $I_D = 0.5 \cdot I_{D25}$		255	nC
$Q_{gs}$			87	nC
$Q_{gd}$			98	nC
$R_{thJC}$			0.13	$^\circ\text{C/W}$
$R_{thCS}$		0.15		$^\circ\text{C/W}$

### Source-Drain Diode

Symbol	Test Conditions ( $T_J = 25^\circ\text{C}$ , Unless Otherwise Specified)	Characteristic Values		
		Min.	Typ.	Max.
$I_S$	$V_{GS} = 0\text{V}$			26 A
$I_{SM}$	Repetitive, Pulse Width Limited by $T_{JM}$			104 A
$V_{SD}$	$I_F = I_S$ , $V_{GS} = 0\text{V}$ , Note 1			1.5 V
$t_{rr}$	$I_F = 13\text{A}$ , $-di/dt = 100\text{A}/\mu\text{s}$ $V_R = 100\text{V}$ , $V_{GS} = 0\text{V}$			300 ns
$Q_{RM}$			1.3	
$I_{RM}$			12.0	A

Note 1. Pulse test,  $t \leq 300\mu\text{s}$ , duty cycle,  $d \leq 2\%$ .

IXYS Reserves the Right to Change Limits, Test Conditions, and Dimensions.

IXYS MOSFETs and IGBTs are covered by one or more of the following U.S. patents:

4,835,592	4,931,844	5,049,961	5,237,481	6,162,665	6,404,065 B1	6,683,344	6,727,585	7,005,734 B2	7,157,338B2
4,850,072	5,017,508	5,063,307	5,381,025	6,259,123 B1	6,534,343	6,710,405 B2	6,759,692	7,063,975 B2	
4,881,106	5,034,796	5,187,117	5,486,715	6,306,728 B1	6,583,505	6,710,463	6,771,478 B2	7,071,537	

### TO-264 Outline

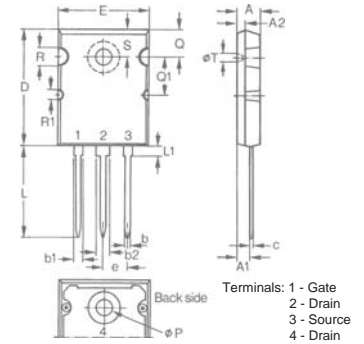

Dim.	Millimeter		Inches	
	Min.	Max.	Min.	Max.
A	4.82	5.13	.190	.202
A1	2.54	2.89	.100	.114
A2	2.00	2.10	.079	.083
b	1.12	1.42	.044	.056
b1	2.39	2.69	.094	.106
b2	2.90	3.09	.114	.122
c	0.53	0.83	.021	.033
D	25.91	26.16	1.020	1.030
E	19.81	19.96	.780	.786
e	5.46 BSC		.215 BSC	
J	0.00	0.25	.000	.010
K	0.00	0.25	.000	.010
L	20.32	20.83	.800	.820
L1	2.29	2.59	.090	.102
P	3.17	3.66	.125	.144
Q	6.07	6.27	.239	.247
Q1	8.38	8.69	.330	.342
R	3.81	4.32	.150	.170
R1	1.78	2.29	.070	.090
S	6.04	6.30	.238	.248
T	1.57	1.83	.062	.072

### PLUS247™ Outline

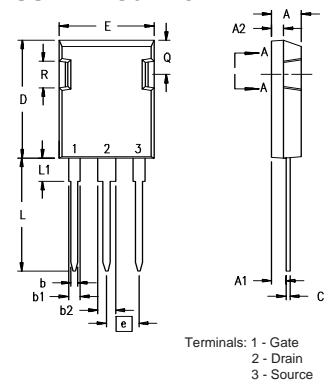

Dim.	Millimeter		Inches	
	Min.	Max.	Min.	Max.
A	4.83	5.21	.190	.205
A1	2.29	2.54	.090	.100
A2	1.91	2.16	.075	.085
b	1.14	1.40	.045	.055
b1	1.91	2.13	.075	.084
b2	2.92	3.12	.115	.123
C	0.61	0.80	.024	.031
D	20.80	21.34	.819	.840
E	15.75	16.13	.620	.635
e	5.45 BSC		.215 BSC	
L	19.81	20.32	.780	.800
L1	3.81	4.32	.150	.170
Q	5.59	6.20	.220	0.244
R	4.32	4.83	.170	.190

**Fig. 1. Output Characteristics @  $T_J = 25^\circ\text{C}$**

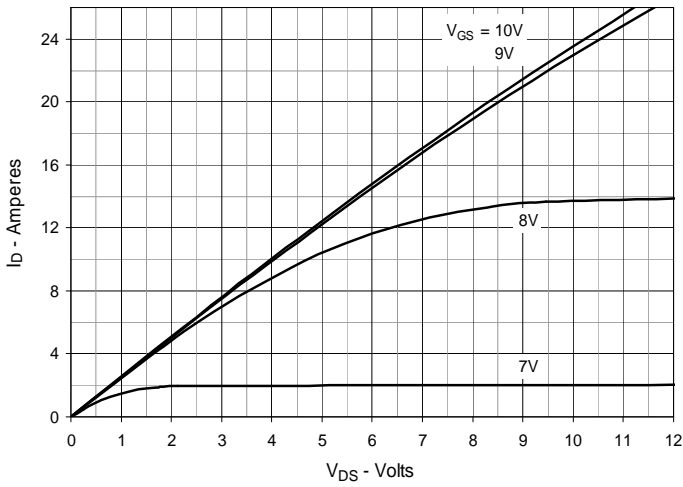

**Fig. 2. Extended Output Characteristics @  $T_J = 25^\circ\text{C}$**

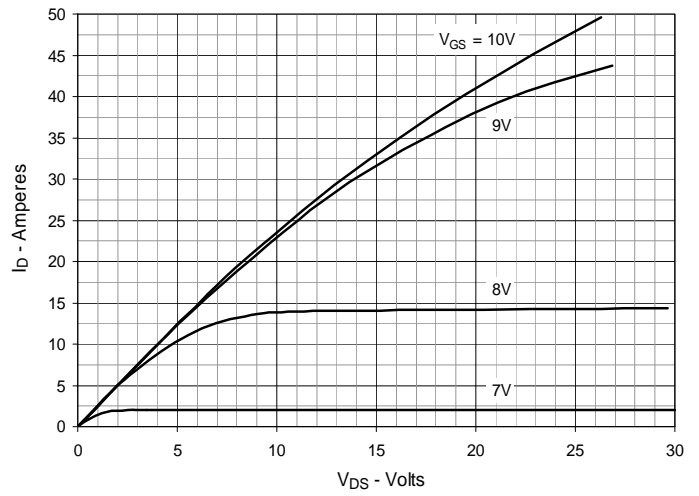

**Fig. 3. Output Characteristics @  $T_J = 125^\circ\text{C}$**

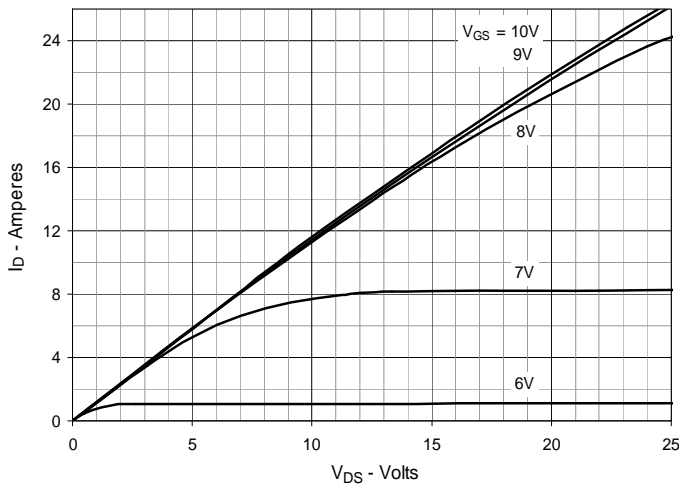

**Fig. 4.  $R_{DS(on)}$  Normalized to  $I_D = 13\text{A}$  Value vs. Junction Temperature**

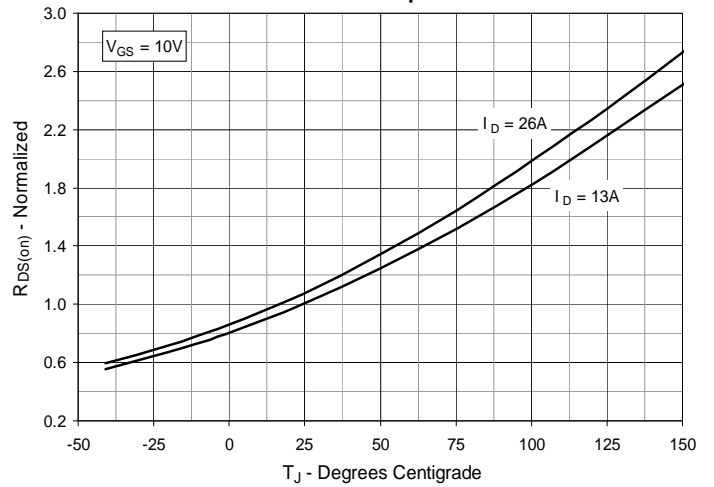

**Fig. 5.  $R_{DS(on)}$  Normalized to  $I_D = 13\text{A}$  Value vs. Drain Current**

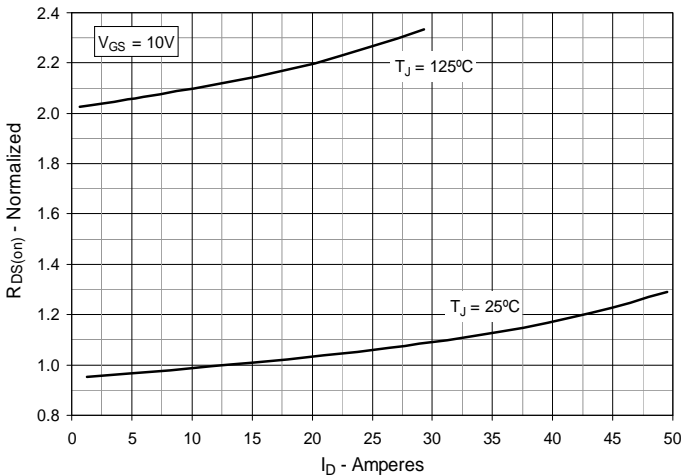

**Fig. 6. Maximum Drain Current vs. Case Temperature**

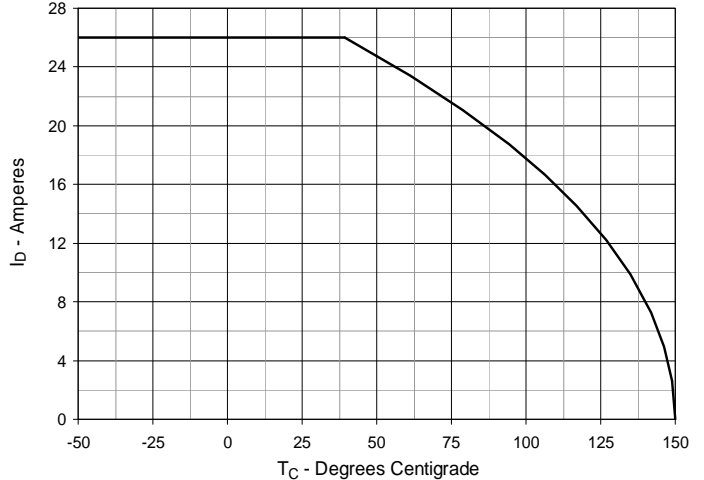

**Fig. 7. Input Admittance**

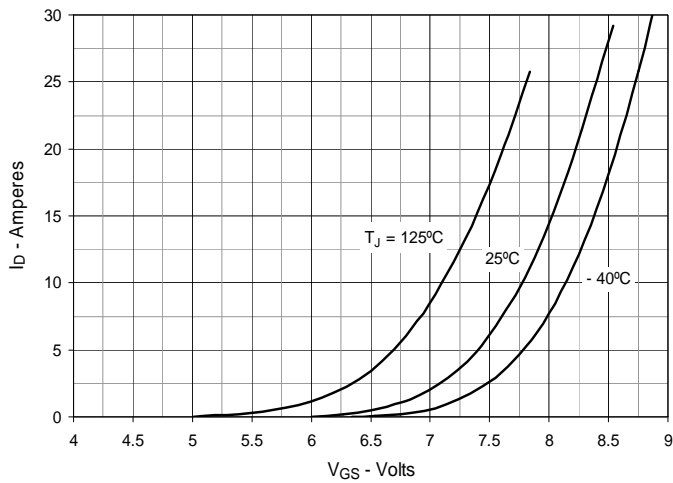

**Fig. 8. Transconductance**

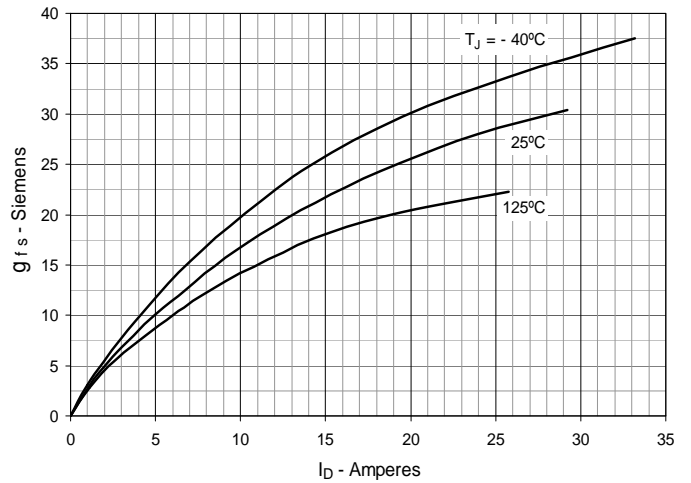

**Fig. 9. Forward Voltage Drop of Intrinsic Diode**

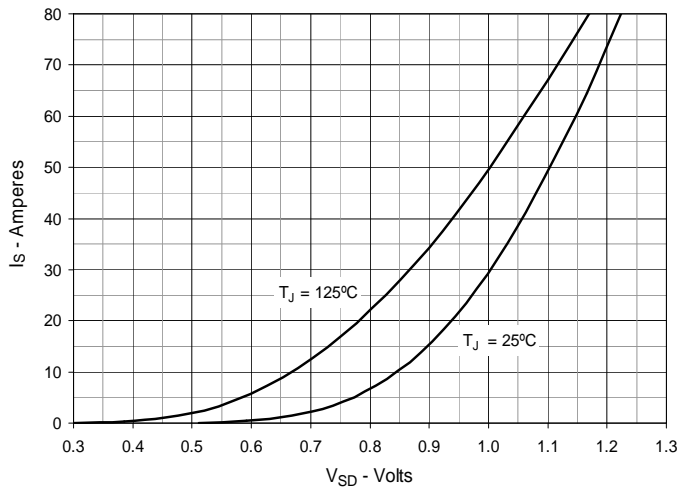

**Fig. 10. Gate Charge**

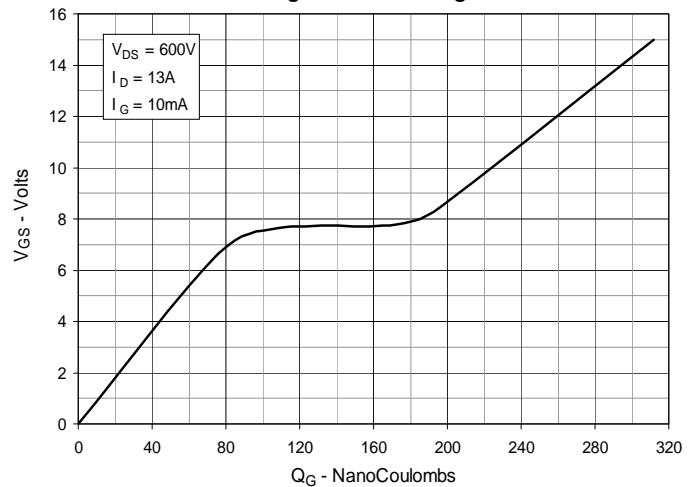

**Fig. 11. Capacitance**

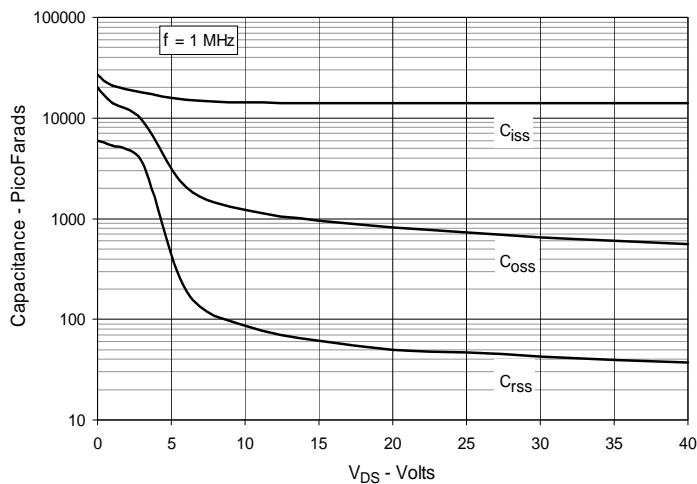

**Fig. 12 Maximum Transient Thermal Impedance**

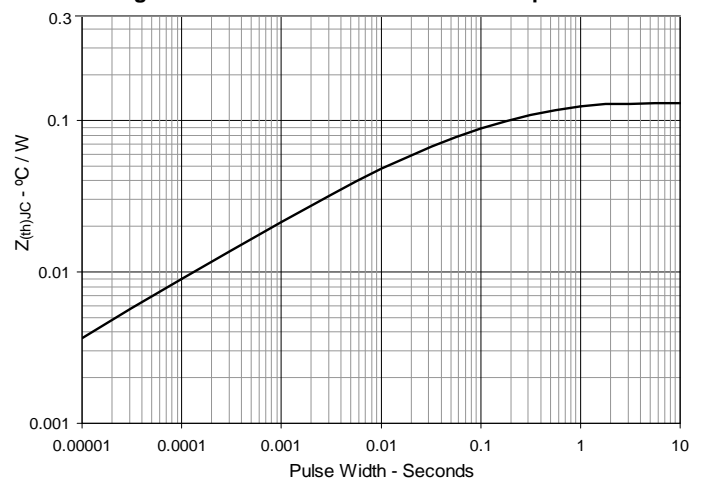

# Mouser Electronics

Authorized Distributor

Click to View Pricing, Inventory, Delivery & Lifecycle Information:

[IXYS:](#)

[IXFX26N120P](#) [IXFK26N120P](#)