

HPR12K-00

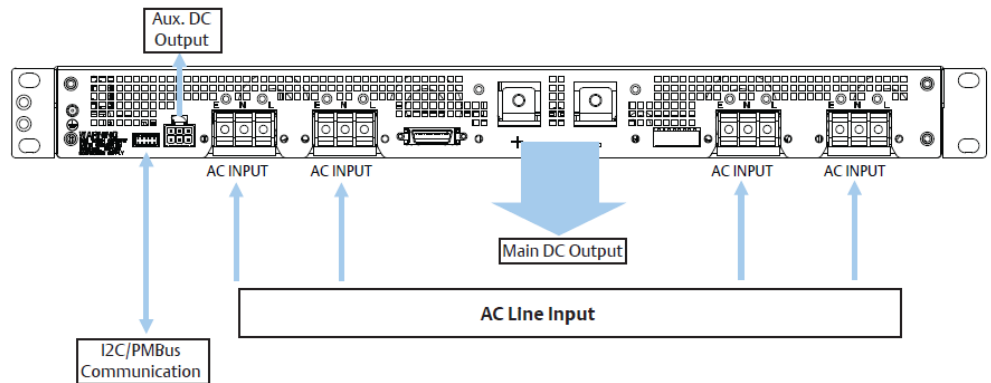

1. General Install

Connecting the input power cable, output load cable and communication wire according to the below figure.



2. General Settings

Unless otherwise specified, when the PSON# switch is de-asserted (48V o/p is disabled). It means Manual ON/OFF DIP switch SW1 should be default according to below table. And It must be checked before shipping.

DIP switch SW1 setting as a default

Power Supplies Status	PSU 1#		PSU 2#		PSU 3#		PSU 4#	
	CH 1	CH2	CH 3	CH 4	CH 5	CH 6	CH 7	CH8
OFF	Up	Down	Up	Down	Up	Down	Up	Down

Note 1. The status Down means set to ON position. The status UP means set to OFF position.

Note 2. Programming Switch SW1 default settings: PSON switches : OFF PSKILL switches : ON

3. ON/OFF Operation (PSON#)

3.1 Manual ON/OFF Operation

The DIP switch SW1 used turn on or off the PSU by manually. The PSU in SLOT1 is turn on when the CH1 of DIP switch SW1 turn on. The other PSU see Table 1.

Note : DIP switch CH2 should be set to ON as a default. Incase if CH2 is set to off, Power supply is slot 1 will not turn on even if CH1 is set to ON position.

Table 1 PSON# Switch Characteristics

Power Supplies Status	PSU 1#		PSU 2#		PSU 3#		PSU 4#	
ON	Down	Down	Down	Down	Down	Down	Down	Down
OFF	Up	Down	Up	Down	Up	Down	Up	Down

Note. The status Down means set to ON position. The status UP means set to OFF position.

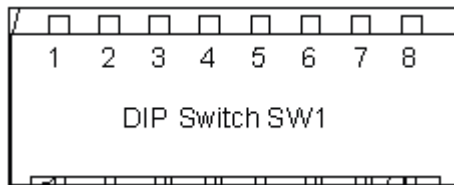

Figure 1: DIP Switch for ON/OFF Operation

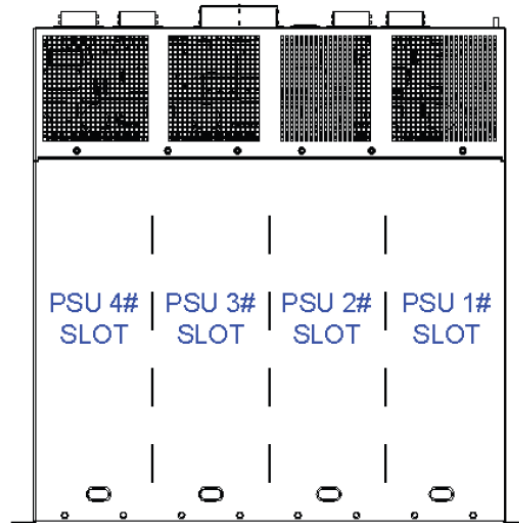

Figure 2: The SLOTS define of Rack

3.2 Remote ON/OFF

The per PSON# signal is required to remotely turn on/off the power supply. PSON# is an active low signal that turns on the +48VDC power rail. When this signal is not pulled low by the system, or left open, the +48VDC output turns off. The 5Vsb output remains on. This signal is pulled to a standby voltage by a pull-up resistor internal to the power supply. The power supply fan(s) shall operate at the lowest speed.

Table 2 PSON# Signal Characteristics

Signal Type	Accepts an open collector/drain input from the system. Pulled-up to the 3V3sb located inside the power supply.	
PSON# = Low PSON# = Open	ON	
	OFF	
Logic level low (power supply ON) Logic level high (power supply OFF)	MIN	MAX
	0V	0.4V
Source current, Vpson = low Power up delay: T pson_on_delay	2.4V	3.4V
		4mA
	5msec	400msec

Refer to IPS of HPS3000-9 PN: 41966008950

4. PMBus Communication

The per power supplies can be communicated with computer by our GUI interface hardware and software.



5. Connector Define for I/O

5.1 Main Output Connection

Table 3 Main Output Connection Definition

No.	Designation	Identification	Terminal Type
+48Vdc	+	MAIN OUTPUT	Ring Lug, M6 screw
+48V_RTN	-	MAIN OUTPUT RETURN	Ring Lug, M6 screw

Mating Terminal screw: SUPPLY TECHNOLOGIES 6040289-0010-EC-A

5.2 PMBus Communication Connection

Use output connector below table5 , Description named CN1.

Table 4 PMBus Output Connector

Self Connector	Mating Connector
Landwin 2051P1000T	Housing: Landwin 2050S1000 or JST PHDR-10VS
((Astec P/N: 13866002800))	Pins: Landwin 2053T011P or JST SPHD-002T-P0.5 (28-24) JST SPHD-001T-P0.5 (26-22)

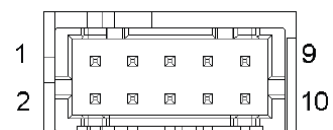

Figure 3: Connector CN1

Table 5 Output Connection Definitions for PMBus

Signal	Name Description	Pin Qty.	Pin Number (s)
SCL	Serial Clock Signal	1	4
SDA	Serial Data Signal	1	2
Ishare	Load Share Bus	1	7
5Vsb	5Vsb External Bus	1	1
Sys_GND	Secondary Return	1	3
Unused		1	5, 6, 8, 9, 10

5.3 5V Stand-By Auxiliary Output CN2

Table 6 PMBus Output Connector

Self Connector	Mating Connector
Tyco: 1-794528-1	Tyco: 794657-6
(Astec P/N: 13870012770)	

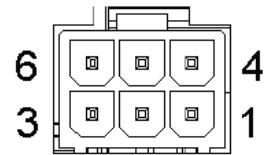

Figure 4: Connector CN2

Table 7 Output Connection Definitions for 5V Standby

Signal	Name Description	Pin Qty.	Pin Number (s)
Stby_Rtn_Sense	Return sense for Stby gnd	1	1
5Vsb	5Vsb External Bus	2	2,3
Sys_GND	Standby GND	2	5,6
Unused		1	4

5.4 Signal Output Connector CN3

Table 8 Signal Output Connector

Self Connector	Mating Connector
Tyco 2-5178238-4	Tyco: 2-5175677-4
(Astec P/N: 13870011610)	

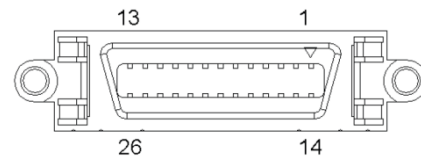

Figure 5: Connector CN3

Table 9 Output Connection Definitions for 5V Standby

Signal	Name Description	Pin Qty.	Pin Number (s)
SYS_GND	Standby GND	2	1,14
UNIT1_PRESENT#	Power supply present for Unit 1	1	2
UNIT2_PRESENT#	Power supply present for Unit 2	1	3
UNIT3_PRESENT#	Power supply present for Unit 3	1	4
UNIT4_PRESENT#	Power supply present for Unit 4	1	5
UNIT1_DCOK/PWOK#	Power OK output for Unit 1	1	6
UNIT2_DCOK/PWOK#	Power OK output for Unit 2	1	7
UNIT3_DCOK/PWOK#	Power OK output for Unit 3	1	8
UNIT4_DCOK/PWOK#	Power OK output for Unit 4	1	9
UNIT1_ACOK#	AC input present for Unit 1	1	10
UNIT2_ACOK#	AC input present for Unit 2	1	11
UNIT3_ACOK#	AC input present for Unit 3	1	12
UNIT4_ACOK#	AC input present for Unit 4	1	13
UNIT1_PSON#	Power enable input for Unit 1	1	15
UNIT2_PSON#	Power enable input for Unit 2	1	16
UNIT3_PSON#	Power enable input for Unit 3	1	17
UNIT4_PSON#	Power enable input for Unit 4	1	18
UNIT1_PSKILL	Minimize arching damage to the power pins	1	19
UNIT2_PSKILL	Minimize arching damage to the power pins	1	20
UNIT3_PSKILL	Minimize arching damage to the power pins	1	21
UNIT4_PSKILL	Minimize arching damage to the power pins	1	22
UNIT1_#ALERT	Warning signal	1	23
UNIT2_#ALERT	Warning signal	1	24
UNIT3_#ALERT	Warning signal	1	25
UNIT4_#ALERT	Warning signal	1	26

5.5 Input Connection Definition

For Functional Test (NHR – initial testing), the following connection applies.

Table 10 Input Connection Definition

No.	Designation	Identification	Terminal Type
L	VINP	Input Voltage Positive	Ring Lug, #12 screw
N	VINN	Input Voltage Negative	Ring Lug, #12 screw
E	MGND	Module Ground (chassis)	Mounting Hardware

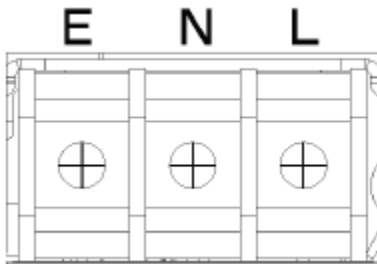

Figure 6: Input connector

Table 11 Input Connection and Mating Terminal

Self Connector	Mating Connector
Bussman: A207403R46	Molex: 19073-0222 or Equivalent
(Astec P/N: 15000300070)	

WORLDWIDE OFFICES

Americas

2900 S.Diablo Way
Tempe, AZ 85282
USA
+1 888 412 7832

Europe (UK)

Waterfront Business Park
Merry Hill, Dudley
West Midlands, DY5 1LX
United Kingdom
+44 (0) 1384 842 211

Asia (HK)

14/F, Lu Plaza
2 Wing Yip Street
Kwun Tong, Kowloon
Hong Kong
+852 2176 3333

ARTESYN[™]
EMBEDDED TECHNOLOGIES

www.artesyn.com

While every precaution has been taken to ensure accuracy and completeness in this literature, Artesyn Embedded Technologies assumes no responsibility, and disclaims all liability for damages resulting from use of this information or for any errors or omissions. Artesyn Embedded Technologies, Artesyn and the Artesyn Embedded Technologies logo are trademarks and service marks of Artesyn Technologies, Inc. All other names and logos referred to are trade names, trademarks, or registered trademarks of their respective owners.
© 2014 All rights reserved.

For more information: www.artesyn.com/power
For support: productsupport.ep@artesyn.com

Mouser Electronics

Authorized Distributor

Click to View Pricing, Inventory, Delivery & Lifecycle Information:

[Artesyn Embedded Technologies:](#)

[HPR12K-00](#) [HPR12K-00-001](#)