

Quad channel high side solid state relay

Features

Max supply voltage	V_{CC}	36V
Max On-state resistance	R_{ON}	35m Ω ⁽¹⁾
Current limitation (typ.)	I_{LIM}	25A

1. Per each channel.

- DC short circuit current: 25A
- CMOS compatible inputs
- Proportional load current sense.
- Undervoltage & overvoltage shutdown
- Overvoltage clamp
- Thermal shutdown
- Current limitation
- Very low standby power dissipation
- Protection against:
 - Loss of ground & loss of V_{CC}
- Reverse battery protection ^(a)

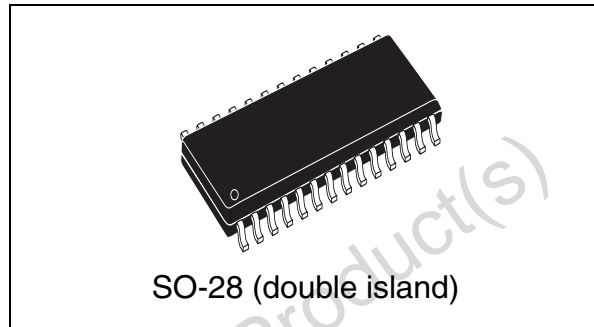

Description

The VNQ600 is a quad HSD formed by assembling two VND600 chips in the same SO-28 package. The VNQ600 is a monolithic device designed in STMicroelectronics VIPower M0-3 Technology. The VNQ600 is intended for driving any type of multiple loads with one side connected to ground.

This device has four independent channels and four analog sense outputs which deliver currents proportional to the outputs currents.

Active current limitation combined with thermal shutdown and automatic restart protect the device against overload. Device automatically turns off in case of ground pin disconnection.

a. See [Application schematic on page 17](#)

Table 1. Device summary

Package	Order codes	
	Tube	Tape and reel
SO-28 (double island)	VNQ600	VNQ60013TR

Contents

1	Block diagram and pin description	5
2	Electrical specifications	7
2.1	Absolute maximum ratings	7
2.2	Thermal data	8
2.3	Electrical characteristics	8
2.4	Electrical characteristics curves	15
3	Application information	17
3.1	GND protection network against reverse battery	17
3.1.1	Solution 1: a resistor in the ground line (RGND only)	17
3.1.2	Solution 2: a diode (D _{GND}) in the ground line	18
3.2	Load dump protection	18
3.3	MCU I/O protection	18
3.4	Maximum demagnetization energy (VCC = 13.5V)	19
4	Package and PCB thermal data	20
4.1	SO-28 thermal data	20
5	Package and packing information	23
5.1	ECOPACK® packages	23
5.2	SO-28 packing information	24
6	Revision history	25

List of tables

Table 1.	Device summary	1
Table 2.	Suggested connections for unused and not connected pins	6
Table 3.	Absolute maximum rating	7
Table 4.	Thermal data (per island)	8
Table 5.	Power	9
Table 6.	Protections	9
Table 7.	Switching ($V_{CC}=13V$; $T_j = 25^{\circ}C$)	10
Table 8.	Current sense ($9V < V_{CC} < 16V$)	10
Table 9.	Logic inputs.	11
Table 10.	V_{CC} - output diode	11
Table 11.	Truth table.	12
Table 12.	Electrical transient requirements	13
Table 13.	Thermal calculation according to the PCB heatsink area	20
Table 14.	Thermal parameters	22
Table 15.	SO-28 mechanical data	23
Table 16.	Document revision history	25

List of figures

Figure 1.	Block diagram	5
Figure 2.	Configuration diagram (top view)	6
Figure 3.	Current and voltage conventions	8
Figure 4.	I_{OUT}/I_{SENSE} versus I_{OUT}	11
Figure 5.	Switching characteristics	12
Figure 6.	Waveforms	14
Figure 7.	Off state output current	15
Figure 8.	High level input current	15
Figure 9.	Input clamp voltage	15
Figure 10.	Turn-on voltage slope	15
Figure 11.	Overshoot shutdown	15
Figure 12.	Turn-off voltage slope	15
Figure 13.	I_{LIM} vs T_{case}	16
Figure 14.	On state resistance vs V_{CC}	16
Figure 15.	Input high level	16
Figure 16.	Input hysteresis voltage	16
Figure 17.	On state resistance vs T_{case}	16
Figure 18.	Input low level	16
Figure 19.	Application schematic	17
Figure 20.	Maximum turn-off current versus load inductance	19
Figure 21.	SO-28 PC board	20
Figure 22.	$R_{thj-amb}$ Vs PCB copper area in open box free air condition	21
Figure 23.	Thermal impedance junction ambient single pulse	21
Figure 24.	Thermal fitting model of a quad channel HSD in SO-28	22
Figure 25.	SO-28 package dimensions	23
Figure 26.	SO-28 tube shipment (no suffix)	24
Figure 27.	SO-28 tape and reel shipment (suffix "TR")	24

1 Block diagram and pin description

Figure 1. Block diagram

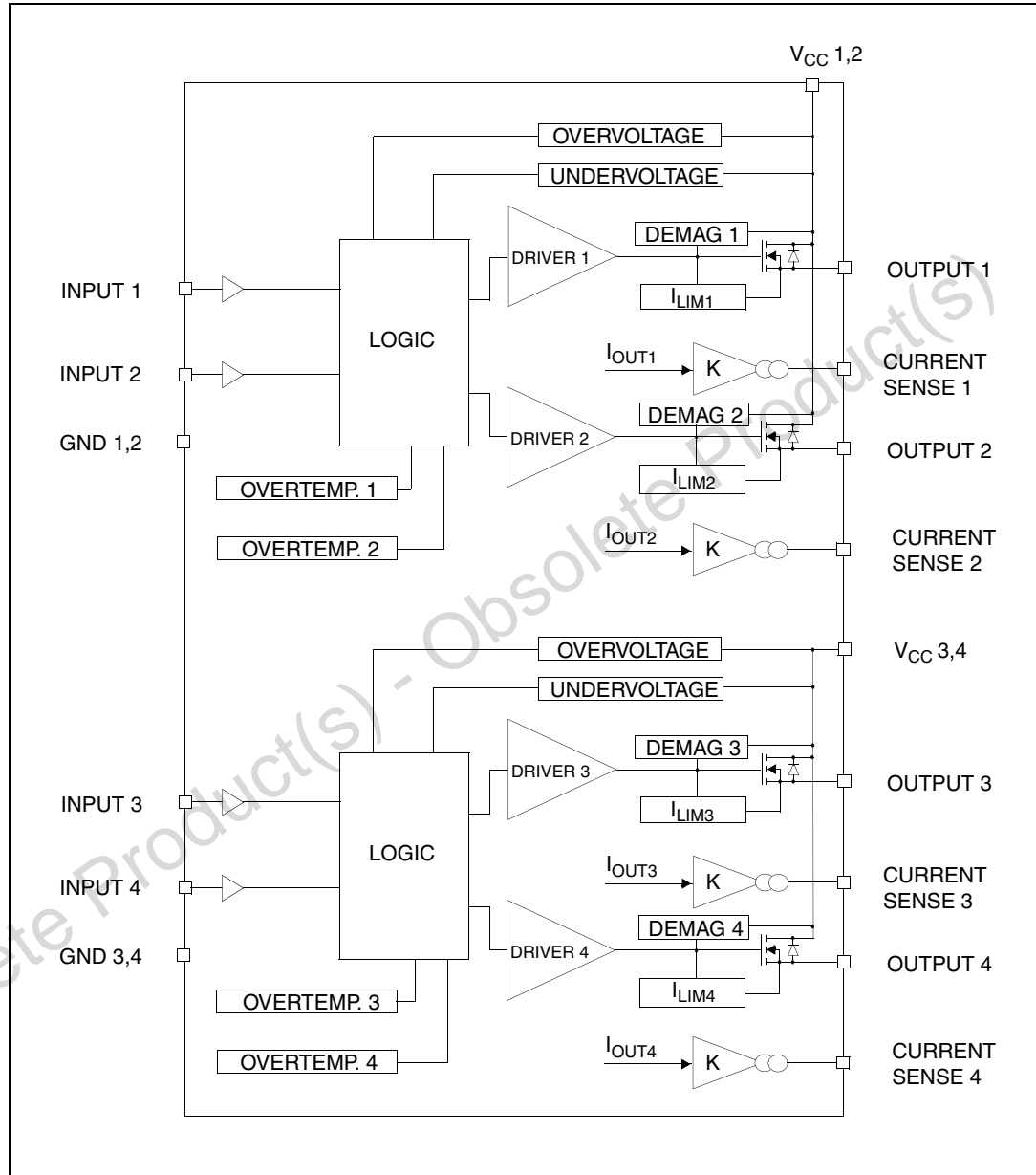

Figure 2. Configuration diagram (top view)

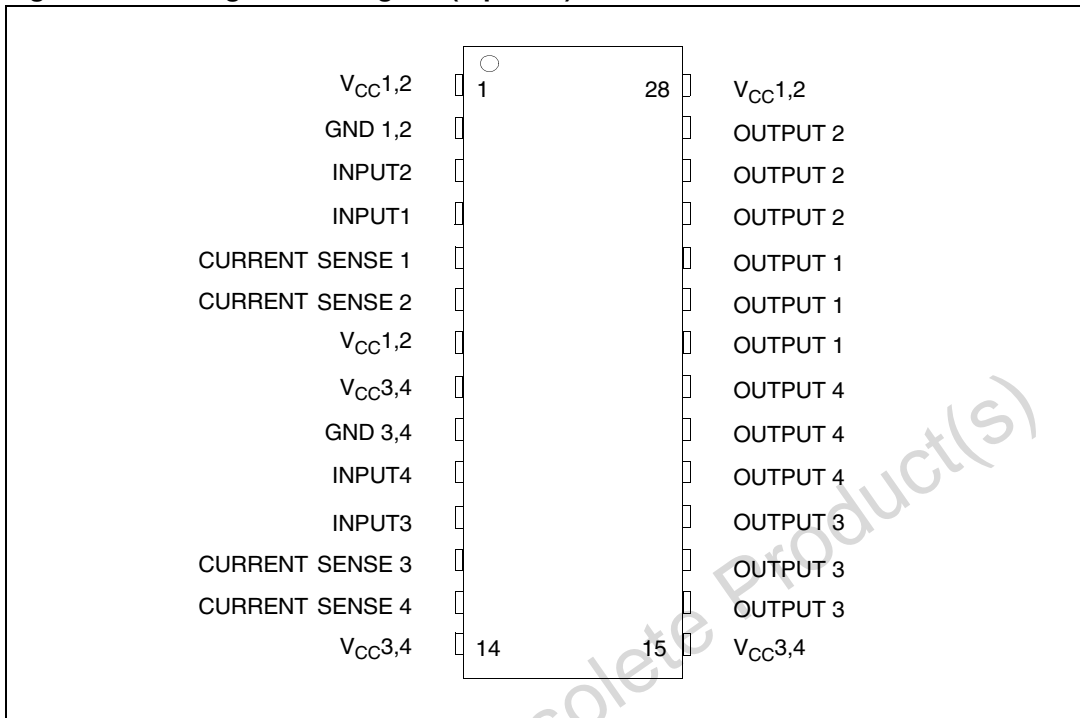

Table 2. Suggested connections for unused and not connected pins

Connection / pin	Current sense	N.C.	Output	Input
Floating		X	X	X
To ground	Through 1KΩ resistor	X		Through 10KΩ resistor

2 Electrical specifications

2.1 Absolute maximum ratings

Stressing the device above the rating listed in the “Absolute maximum ratings” table may cause permanent damage to the device. These are stress ratings only and operation of the device at these or any other conditions above those indicated in the Operating sections of this specification is not implied. Exposure to Absolute Maximum Rating conditions for extended periods may affect device reliability. Refer also to the STMicroelectronics SURE Program and other relevant quality document.

Table 3. Absolute maximum rating

Symbol	Parameter	Value	Unit
V_{CC}	Supply voltage (continuous)	41	V
$-V_{CC}$	Reverse supply voltage (continuous)	-0.3	V
I_{OUT}	Output current (continuous), for each channel	15	A
I_R	Reverse output current (continuous), for each channel	-15	A
I_{IN}	Input current	+/- 10	mA
V_{CSENSE}	Current sense maximum voltage	-3	V
		+15	V
I_{GND}	Ground current at $T_{pins} \leq 25^\circ\text{C}$ (continuous)	-200	mA
V_{ESD}	Electrostatic discharge (Human Body Model: $R=1.5\text{K}\Omega$; $C=100\text{pF}$)		
	- INPUT	4000	V
	- CURRENT SENSE	2000	V
	- OUTPUT	5000	V
	- V_{CC}	5000	V
E_{MAX}	Maximum switching energy ($L=0.11\text{mH}$; $R_L=0\Omega$; $V_{bat}=13.5\text{V}$; $T_{jstart}=150^\circ\text{C}$; $I_L=40\text{A}$)	126	mJ
P_{tot}	Power dissipation (per island) at $T_{lead}=25^\circ\text{C}$	6.25	W
T_j	Junction operating temperature	Internally limited	$^\circ\text{C}$
T_{stg}	Storage temperature	-55 to 150	$^\circ\text{C}$

2.2 Thermal data

Table 4. Thermal data (per island)

Symbol	Parameter	Value		Unit
$R_{thj-lead}$	Thermal resistance junction-lead	20		°C/W
$R_{thj-amb}$	Thermal resistance junction-ambient (one chip ON)	60 ⁽¹⁾	45 ⁽²⁾	°C/W
$R_{thj-amb}$	Thermal Resistance junction-ambient (two chips ON)	46 ⁽¹⁾	31 ⁽²⁾	°C/W

1. When mounted on a standard single-sided FR-4 board with 0.5cm² of Cu (at least 35 μm thick) connected to all V_{CC} pins. Horizontal mounting and no artificial air flow.
2. When mounted on a standard single-sided FR-4 board with 6cm² of Cu (at least 35 μm thick) connected to all V_{CC} pins. Horizontal mounting and no artificial air flow.

2.3 Electrical characteristics

Values specified in this section are for 8V < V_{CC} < 36V; -40°C < T_j < 150°C, unless otherwise stated.

Figure 3. Current and voltage conventions

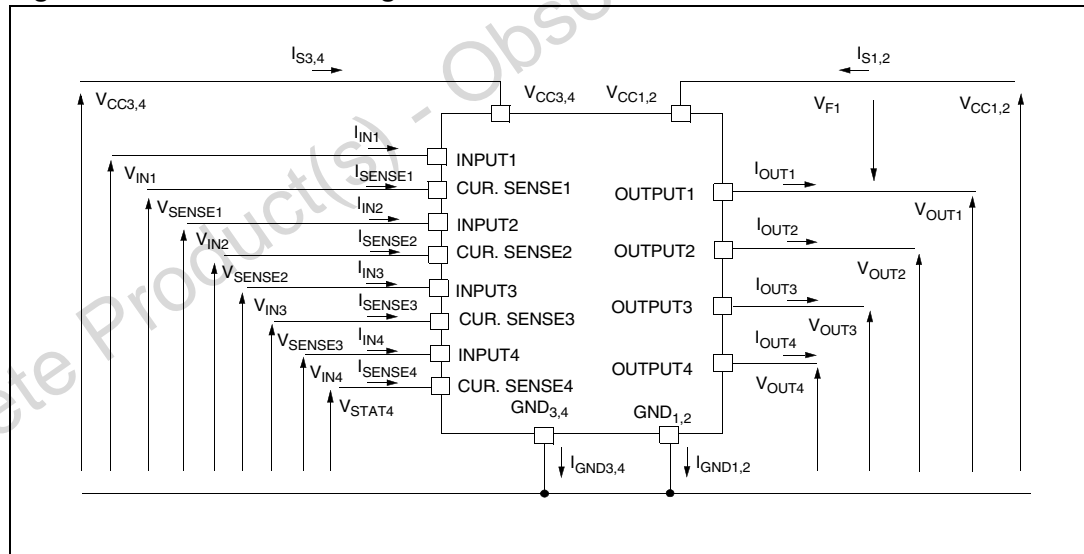

Note: $V_{Fn} = V_{CCn} - V_{OUTn}$ during reverse battery condition.

Table 5. Power

Symbol	Parameter	Test conditions	Min.	Typ.	Max.	Unit
V _{CC}	Operating supply voltage		5.5	13	36	V
V _{USD}	Undervoltage shutdown		3	4	5.5	V
V _{OV}	Overvoltage shutdown		36			V
R _{ON}	On state resistance	I _{OUT} 1,2,3,4=5A; T _j =25°C			35	mΩ
		I _{OUT} 1,2,3,4=5A; T _j =150°C			70	mΩ
		I _{OUT} 1,2,3,4=3A; V _{CC} =6V			120	mΩ
V _{clamp}	Clamp voltage	I _{CC} =20mA	41	48	55	V
I _S	Supply current	Off State; V _{CC} =13V; V _{IN} =V _{OUT} =0V		12	40	μA
		Off State; V _{CC} =13V; V _{IN} =V _{OUT} =0V; T _j =25°C		12	25	μA
		On State; V _{CC} =13V; V _{IN} =5V; I _{OUT} =0A; R _{SENSE} =3.9KΩ				6
I _{L(off1)}	Off state output current	V _{IN} =V _{OUT} =0V	0		50	μA
I _{L(off2)}	Off state output current	V _{IN} =0V; V _{OUT} =3.5V	-75		0	μA
I _{L(off3)}	Off state output current	V _{IN} =V _{OUT} =0V; V _{CC} =13V; T _j =125°C			5	μA
I _{L(off4)}	Off state output current	V _{IN} =V _{OUT} =0V; V _{CC} =13V; T _j =25°C			3	μA

Note: V_{clamp} and V_{OV} are correlated. Typical difference is 5V.

Table 6. Protections

Symbol	Parameter	Test conditions	Min.	Typ.	Max.	Unit
I _{lim}	DC Short circuit current	V _{CC} =13V	25	40	70	A
		5.5V<V _{CC} <36V			70	A
T _{TSD}	Thermal shutdown temperature		150	175	200	°C
T _R	Thermal reset temperature		135			°C
T _{hyst}	Thermal hysteresis		7	15		°C
V _{demag}	Turn-off output voltage clamp	I _{OUT} =2A; L=6mH	V _{CC} -41	V _{CC} -48	V _{CC} -55	V
V _{ON}	Output voltage drop limitation	I _{OUT} =0.5A; T _j = -40°C...+150°C		50		mV

Note: To ensure long term reliability under heavy overload or short circuit conditions, protection and related diagnostic signals must be used together with a proper software strategy. If the device is subjected to abnormal conditions, this software must limit the duration and number of activation cycles.

Table 7. Switching ($V_{CC}=13V$; $T_j = 25^\circ C$)

Symbol	Parameter	Test conditions	Min.	Typ.	Max.	Unit
$t_{d(on)}$	Turn-on delay time	$R_L=2.6\Omega$ channels 1,2,3,4 (see Figure 5)		40		μs
$t_{d(off)}$	Turn-off delay time	$R_L=2.6\Omega$ channels 1,2,3,4 (see Figure 5)		40		μs
$(dV_{OUT}/dt)_{on}$	Turn-on voltage slope	$R_L=2.6\Omega$ channels 1,2,3,4 (see Figure 5)		See Figure 10		V/ μs
$(dV_{OUT}/dt)_{off}$	Turn-off voltage slope	$R_L=2.6\Omega$ channels 1,2,3,4 (see Figure 5)		See Figure 12		V/ μs

Table 8. Current sense ($9V < V_{CC} < 16V$)

Symbol	Parameter	Test conditions	Min.	Typ.	Max.	Unit
K_1	I_{OUT}/I_{SENSE}	I_{OUT1} or $I_{OUT2}=0.5A$; $V_{SENSE}=0.5V$; other channels open; $T_j = -40^\circ C \dots 150^\circ C$	3300	4400	6000	
dK_1/K_1	Current sense ratio drift	I_{OUT1} or $I_{OUT2}=0.35A$; $V_{SENSE}=0.5V$; other channels open; $T_j = -40^\circ C \dots 150^\circ C$	-10		+10	%
K_2	I_{OUT}/I_{SENSE}	I_{OUT1} or $I_{OUT2}=5A$; $V_{SENSE}=4V$; other channels open; $T_j = -40^\circ C$ $T_j = 25^\circ C \dots 150^\circ C$	4200 4400	4900 4900	6000 5750	
dK_2/K_2	Current sense ratio drift	I_{OUT1} or $I_{OUT2}=2A$; $V_{SENSE}=2.5V$; other channels open; $T_j = -40^\circ C \dots 150^\circ C$	-6		+6	%
K_3	I_{OUT}/I_{SENSE}	I_{OUT1} or $I_{OUT2}=15A$; $V_{SENSE}=4V$; other channels open; $T_j = -40^\circ C$ $T_j = 25^\circ C \dots 150^\circ C$	4200 4400	4900 4900	5500 5250	
dK_3/K_3	Current sense ratio drift	I_{OUT1} or $I_{OUT2}=15A$; $V_{SENSE}=4V$; other channels open; $T_j = -40^\circ C \dots 150^\circ C$	-6		+6	%
$V_{SENSE1,2}$	Max analog sense output voltage	$V_{CC}=5.5V$; $I_{OUT1,2}=2.5A$; $R_{SENSE}=10k\Omega$ $V_{CC}>8V$, $I_{OUT1,2}=5A$; $R_{SENSE}=10k\Omega$	2 4			V V
V_{SENSEH}	Analog sense output voltage in overtemperature condition	$V_{CC}=13V$; $R_{SENSE}=3.9k\Omega$		5.5		V

Table 8. Current sense (9V < V_{CC} < 16V) (continued)

Symbol	Parameter	Test conditions	Min.	Typ.	Max.	Unit
R _{VSENSEH}	Analog sense output Impedance in overtemperature condition	V _{CC} =13V; T _j >T _{TSD} ; All channels open		400		Ω
t _{DSENSE}	Current sense delay response	To 90% I _{SENSE} ⁽¹⁾			500	μs

1. Current sense signal delay after positive input slope.

Table 9. Logic inputs

Symbol	Parameter	Test conditions	Min.	Typ.	Max.	Unit
V _{IL}	Low level input voltage				1.25	V
V _{IH}	High level input voltage		3.25			V
V _{I(hyst)}	Input hysteresis voltage		0.5			V
I _{IL}	Input current	V _{IN} =1.5V	1			μA
I _{IN}	Input current	V _{IN} =3.5V			10	μA
V _{ICL}	Input clamp voltage	I _{IN} =1mA I _{IN} = -1mA	6	6.8 -0.7	8	V V

Table 10. V_{CC} - output diode

Symbol	Parameter	Test conditions	Min.	Typ.	Max.	Unit
V _F	Forward on voltage	-I _{OUT} =2.30A; T _j =150°C			0.6	V

Figure 4. I_{OUT}/I_{SENSE} versus I_{OUT}

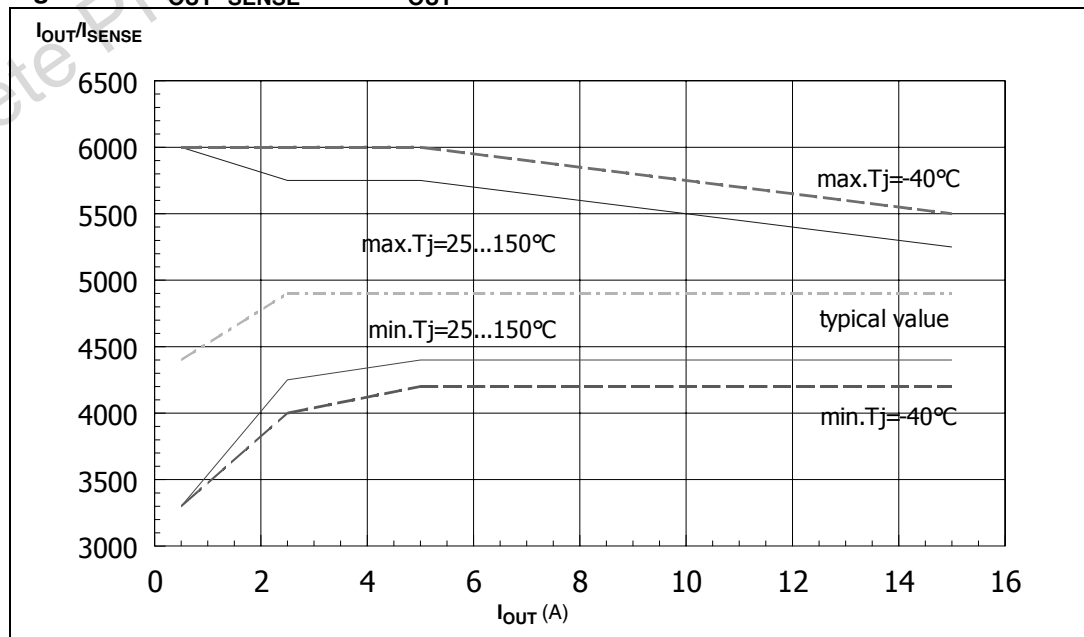

Figure 5. Switching characteristics

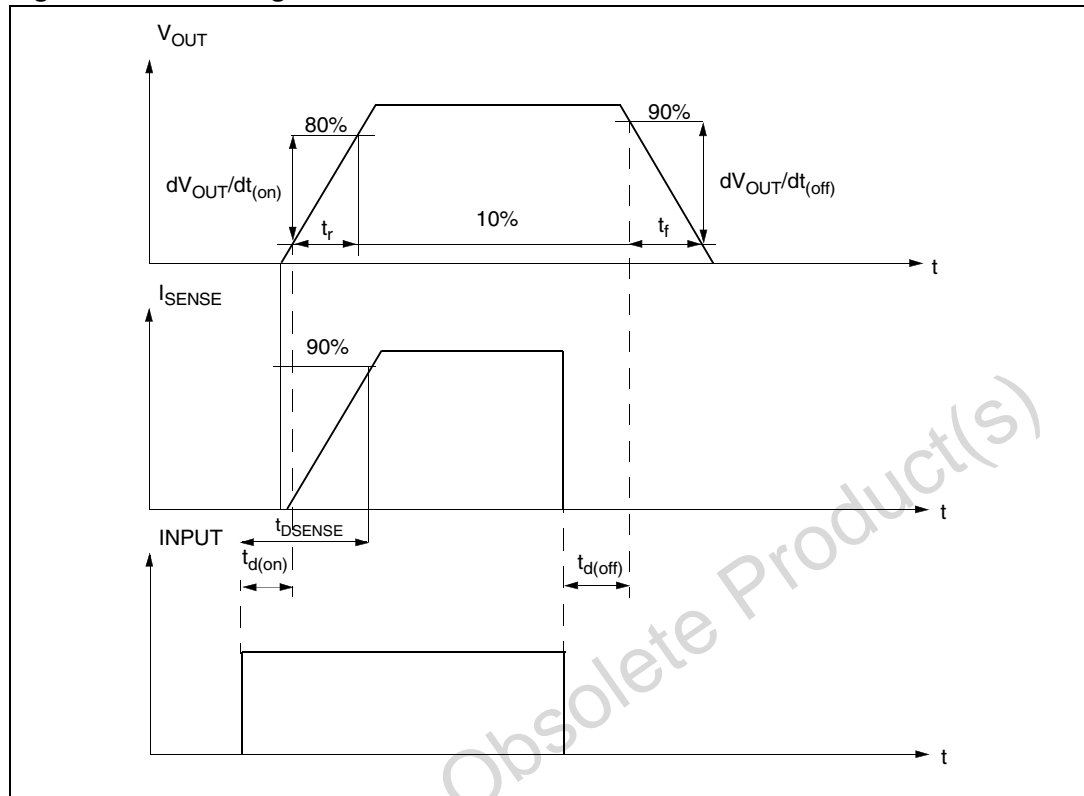

Table 11. Truth table

Conditions	Input	Output	Sense
Normal operation	L	L	0
	H	H	Nominal
Overtemperature	L	L	0
	H	L	V_{SENSEH}
Undervoltage	L	L	0
	H	L	0
Overvoltage	L	L	0
	H	L	0
Short circuit to GND	L	L	0
	H	L	$(T_j < T_{TSD})$ 0 $(T_j > T_{TSD})$ V_{SENSEH}
Short circuit to V_{CC}	L	H	0
	H	H	< Nominal
Negative output voltage clamp	L	L	0

Table 12. Electrical transient requirements

ISO T/R 7637/1 Test pulse	Test levels I	Test levels II	Test levels III	Test levels IV	Test levels delays and impedance
1	-25V	-50V	-75V	-100V	2ms, 10Ω
2	+25V	+50V	+75V	+100V	0.2ms, 10Ω
3a	-25V	-50V	-100V	-150V	0.1μs, 50Ω
3b	+25V	+50V	+75V	+100V	0.1μs, 50Ω
4	-4V	-5V	-6V	-7V	100ms, 0.01Ω
5	+26.5V	+46.5V	+66.5V	+86.5V	400ms, 2Ω

ISO T/R 7637/1 Test pulse	Test levels result I	Test levels result II	Test levels result III	Test levels result IV
1	C	C	C	C
2	C	C	C	C
3a	C	C	C	C
3b	C	C	C	C
4	C	C	C	C
5	C	E	E	E

Class	Contents
C	All functions of the device are performed as designed after exposure to disturbance.
E	One or more functions of the device is not performed as designed after exposure and cannot be returned to proper operation without replacing the device.

Figure 6. Waveforms

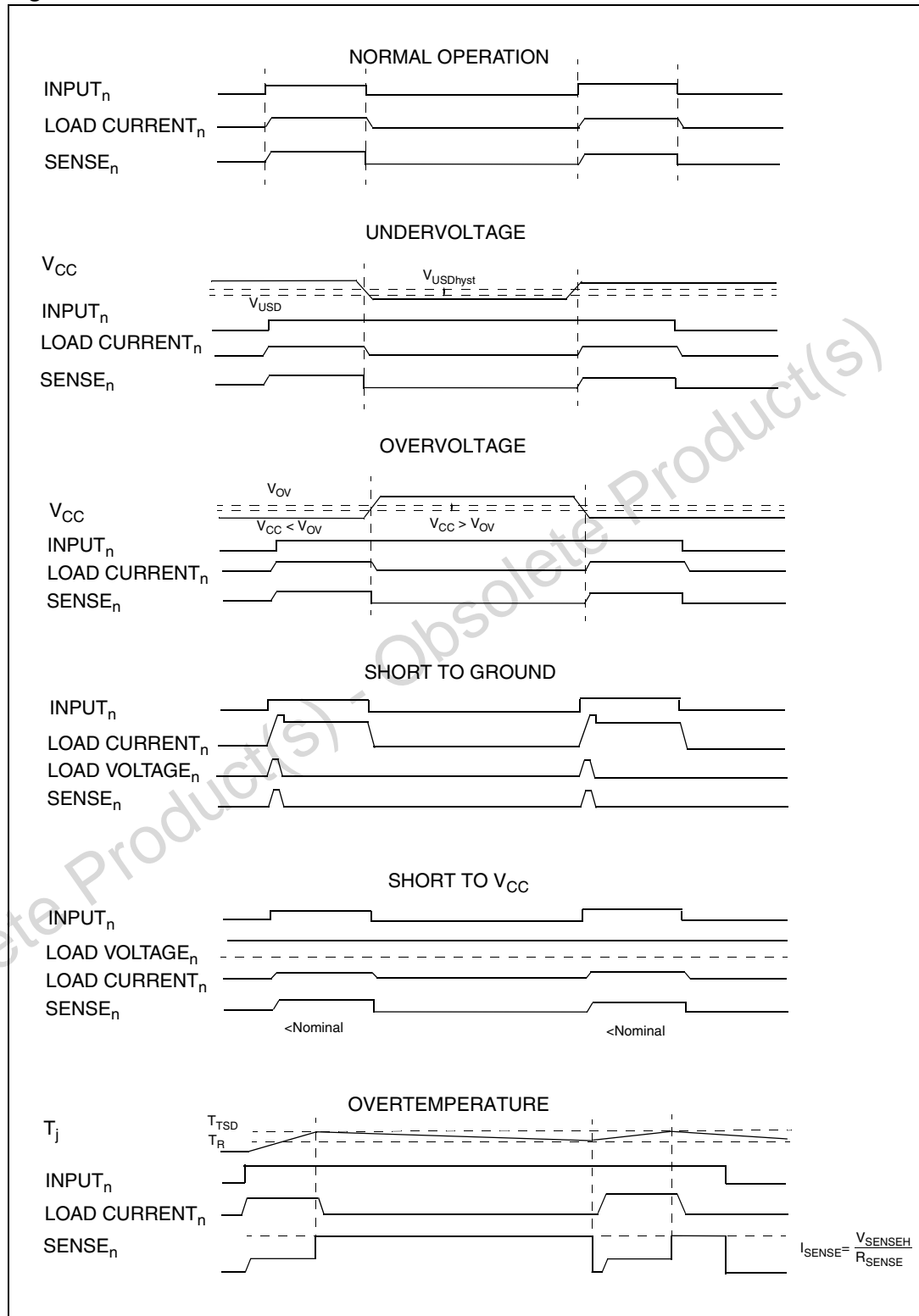

2.4 Electrical characteristics curves

Figure 7. Off state output current

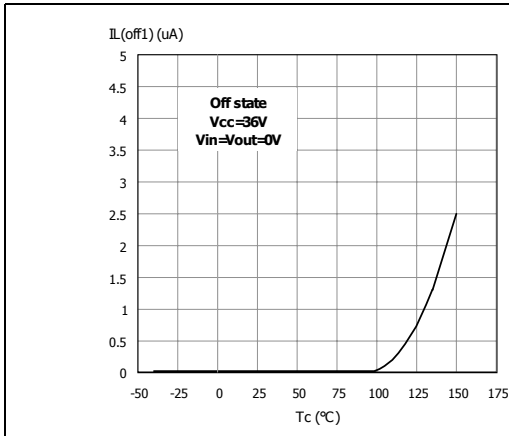

Figure 8. High level input current

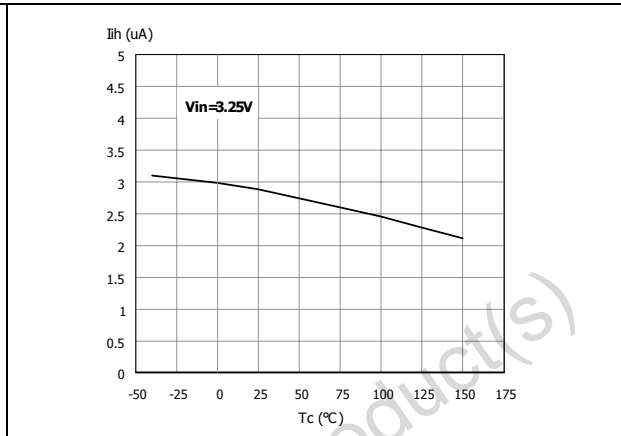

Figure 9. Input clamp voltage

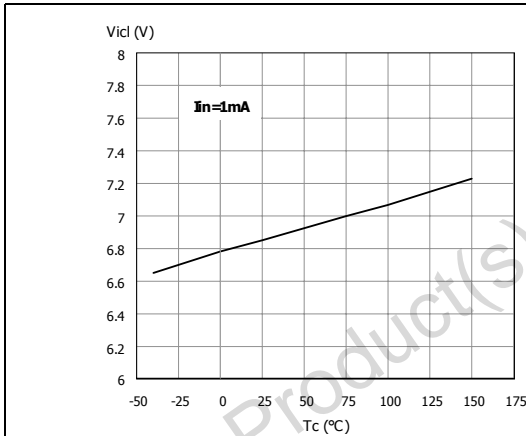

Figure 10. Turn-on voltage slope

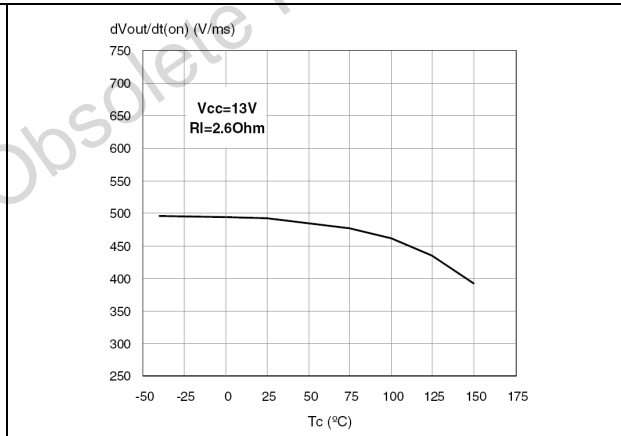

Figure 11. Overvoltage shutdown

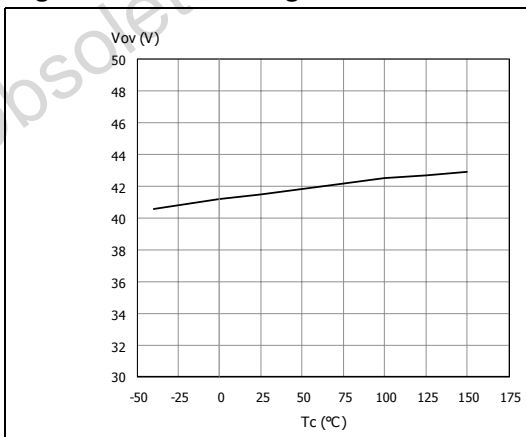

Figure 12. Turn-off voltage slope

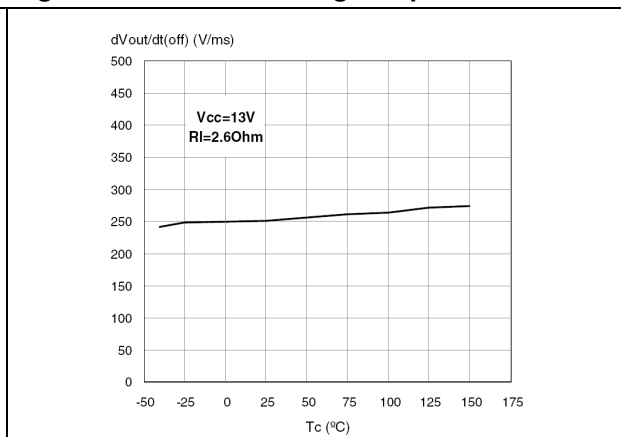

Figure 13. I_{LIM} vs T_{case}

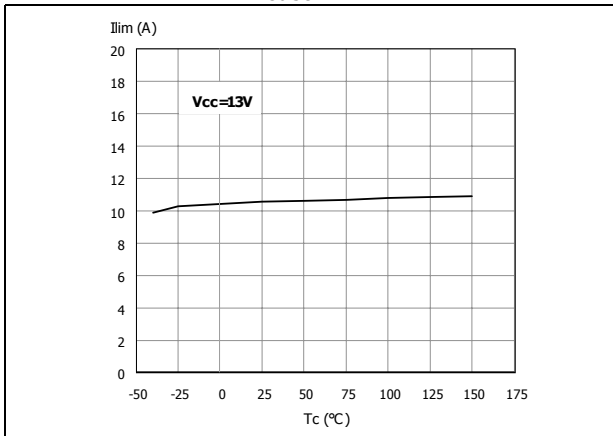

Figure 14. On state resistance vs V_{CC}

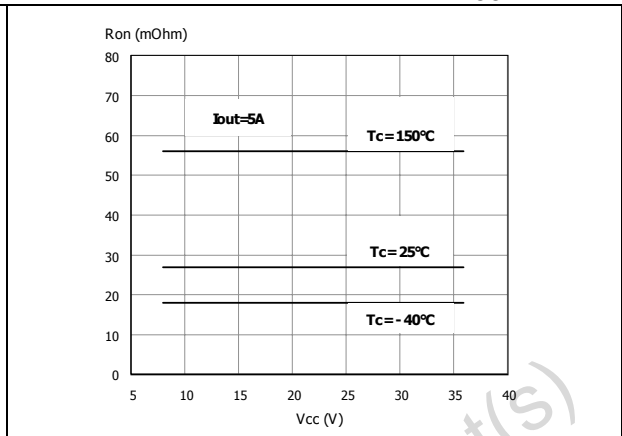

Figure 15. Input high level

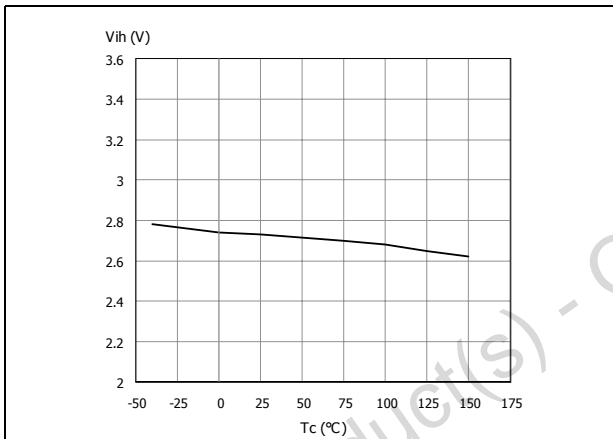

Figure 16. Input hysteresis voltage

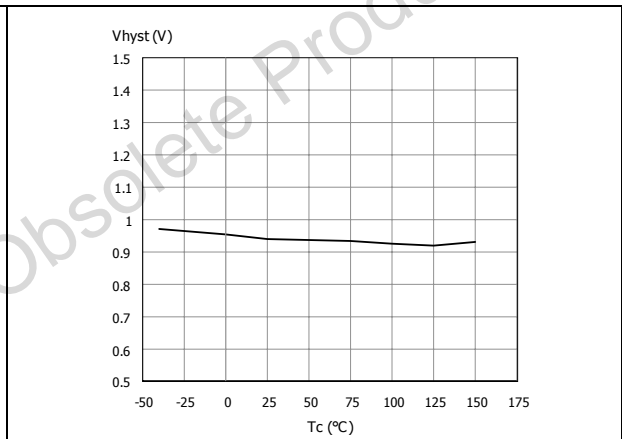

Figure 17. On state resistance vs T_{case}

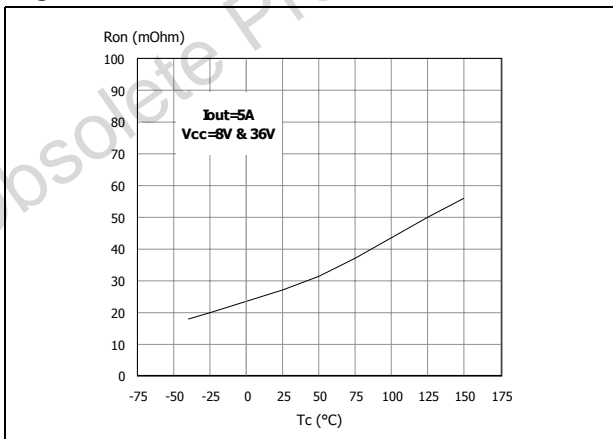
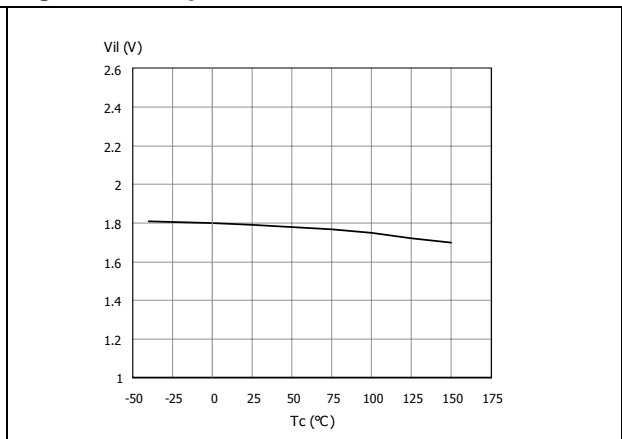
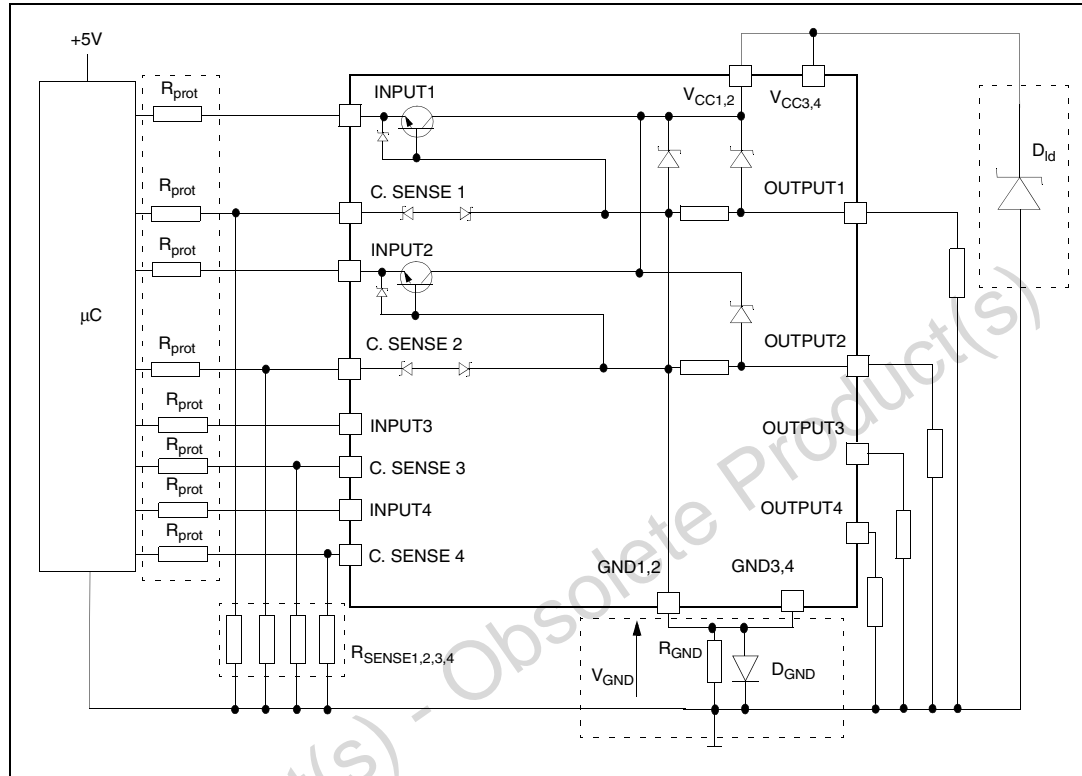

Figure 18. Input low level



3 Application information

Figure 19. Application schematic



Note: Channels 3 & 4 have the same internal circuit as channel 1 & 2.

3.1 GND protection network against reverse battery

This section provides two solutions for implementing a ground protection network against reverse battery.

3.1.1 Solution 1: a resistor in the ground line (R_{GND} only)

This can be used with any type of load.

The following show how to dimension the R_{GND} resistor:

1. $R_{GND} \leq 600\text{mV} / 2(I_{S(on)max})$
2. $R_{GND} \geq (-V_{CC}) / (-I_{GND})$

where $-I_{GND}$ is the DC reverse ground pin current and can be found in the absolute maximum rating section of the device datasheet.

Power dissipation in R_{GND} (when $V_{CC} < 0$ during reverse battery situations) is:

$$P_D = (-V_{CC})^2 / R_{GND}$$

This resistor can be shared amongst several different HSDs. Please note that the value of this resistor should be calculated with formula (1) where $I_{S(on)max}$ becomes the sum of the maximum on-state currents of the different devices.

Please note that, if the microprocessor ground is not shared by the device ground, then the R_{GND} will produce a shift ($I_{S(on)max} * R_{GND}$) in the input thresholds and the status output values. This shift will vary depending on how many devices are ON in the case of several high side drivers sharing the same R_{GND} .

If the calculated power dissipation requires the use of a large resistor, or several devices have to share the same resistor, then ST suggests using solution 2 below.

3.1.2 Solution 2: a diode (D_{GND}) in the ground line

A resistor ($R_{GND}=1k\Omega$) should be inserted in parallel to D_{GND} if the device will be driving an inductive load. This small signal diode can be safely shared amongst several different HSD. Also in this case, the presence of the ground network will produce a shift ($\pm 600mV$) in the input threshold and the status output values if the microprocessor ground is not common with the device ground. This shift will not vary if more than one HSD shares the same diode/resistor network. Series resistor in INPUT and STATUS lines are also required to prevent that, during battery voltage transient, the current exceeds the Absolute Maximum Rating. Safest configuration for unused INPUT and STATUS pin is to leave them unconnected.

3.2 Load dump protection

D_{ld} is necessary (Voltage Transient Suppressor) if the load dump peak voltage exceeds the V_{CC} maximum DC rating. The same applies if the device is subject to transients on the V_{CC} line that are greater than those shown in the ISO T/R 7637/1 table.

3.3 MCU I/O protection

If a ground protection network is used and negative transients are present on the V_{CC} line, the control pins will be pulled negative. ST suggests to insert a resistor (R_{prot}) in line to prevent the μC I/O pins from latching up.

The value of these resistors is a compromise between the leakage current of μC and the current required by the HSD I/Os (Input levels compatibility) with the latch-up limit of μC I/Os:

$$-V_{CCpeak}/I_{latchup} \leq R_{prot} \leq (V_{OH\mu C} - V_{IH} - V_{GND}) / I_{IHmax}$$

Example

For the following conditions:

$$V_{CCpeak} = -100V$$

$$I_{latchup} \geq 20mA$$

$$V_{OH\mu C} \geq 4.5V$$

$$5k\Omega \leq R_{prot} \leq 65k\Omega$$

Recommended values are:

$$R_{prot} = 10k\Omega$$

3.4 Maximum demagnetization energy (Vcc = 13.5V)

Figure 20. Maximum turn-off current versus load inductance

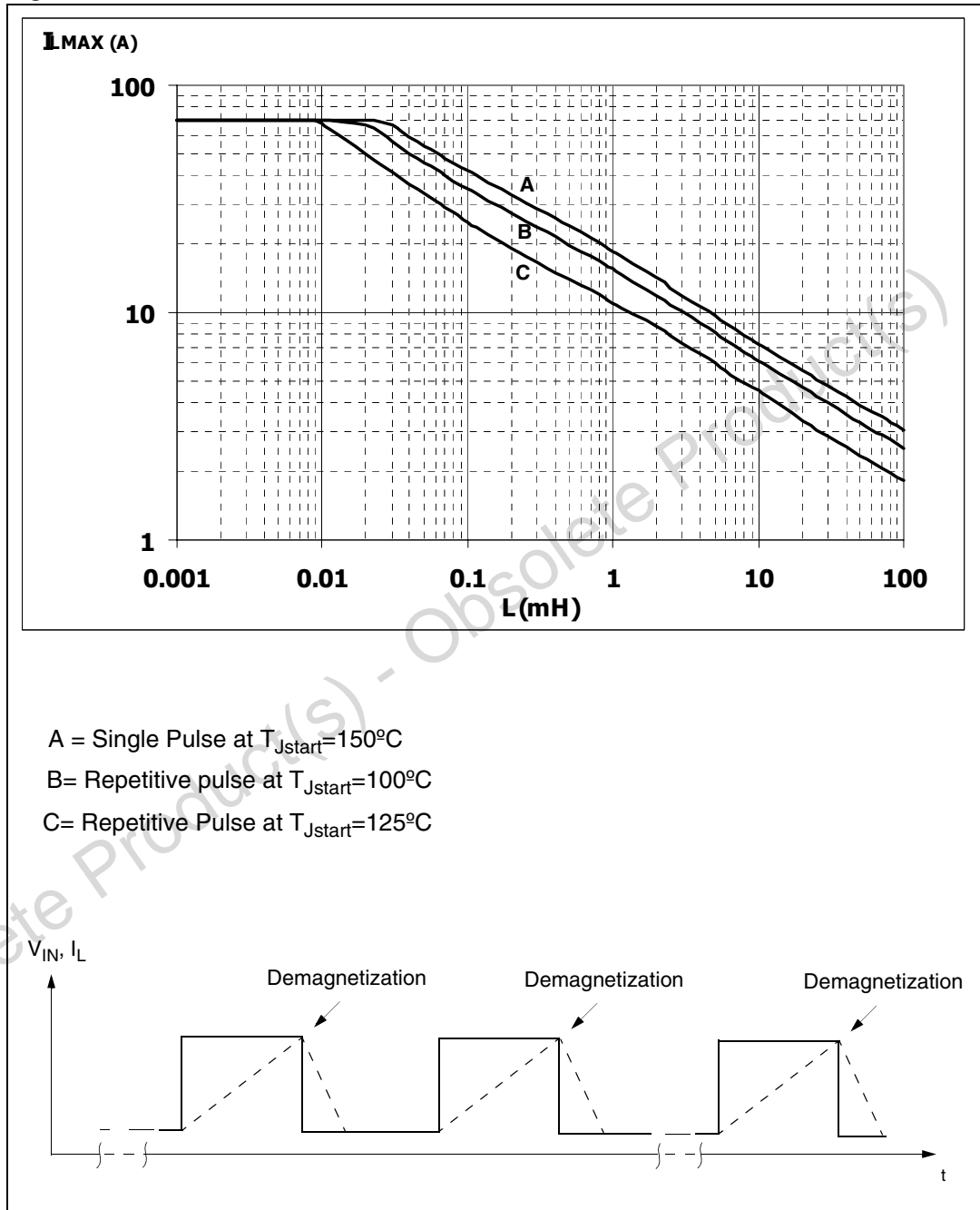

Note:

Values are generated with $R_L=0\Omega$

In case of repetitive pulses, T_{jstart} (at beginning of each demagnetization) of every pulse must not exceed the temperature specified above for curves B and C.

4 Package and PCB thermal data

4.1 SO-28 thermal data

Figure 21. SO-28 PC board

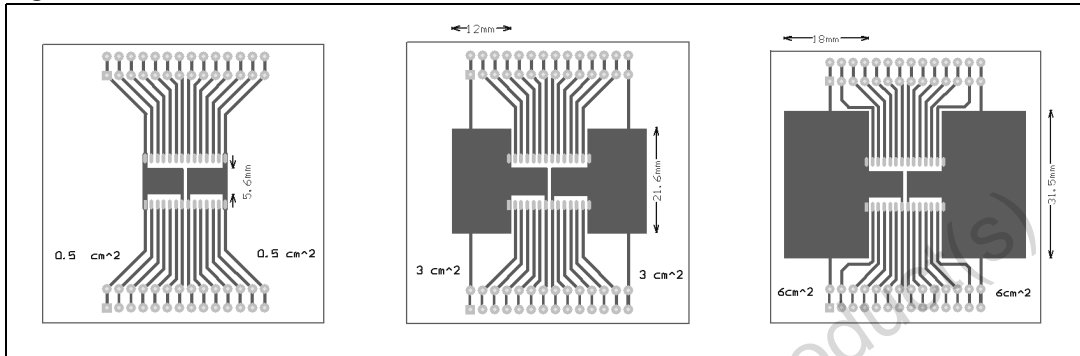

Note: Layout condition of R_{th} and Z_{th} measurements (PCB FR4 area= 58mm x 58mm, PCB thickness=2mm, Cu thickness=35 μ m, Copper areas: 0.5 cm², 3 cm², 6 cm²).

Table 13. Thermal calculation according to the PCB heatsink area

Chip 1	Chip 2	T_{jchip1}	T_{jchip2}	Note
ON	OFF	$R_{thA} \times P_{dchip1} + T_{amb}$	$R_{thC} \times P_{dchip1} + T_{amb}$	
OFF	ON	$R_{thC} \times P_{dchip2} + T_{amb}$	$R_{thA} \times P_{dchip2} + T_{amb}$	
ON	ON	$R_{thB} \times (P_{dchip1} + P_{dchip2}) + T_{amb}$	$R_{thB} \times (P_{dchip1} + P_{dchip2}) + T_{amb}$	$P_{dchip1} = P_{dchip2}$
ON	ON	$(R_{thA} \times P_{dchip1}) + R_{thC} \times P_{dchip2} + T_{amb}$	$(R_{thA} \times P_{dchip2}) + R_{thC} \times P_{dchip1} + T_{amb}$	$P_{dchip1} \neq P_{dchip2}$

R_{thA} = Thermal resistance Junction to Ambient with one chip ON

R_{thB} = Thermal resistance Junction to Ambient with both chips ON and $P_{dchip1} = P_{dchip2}$

R_{thC} = Mutual thermal resistance

Figure 22. $R_{thj-amb}$ Vs PCB copper area in open box free air condition

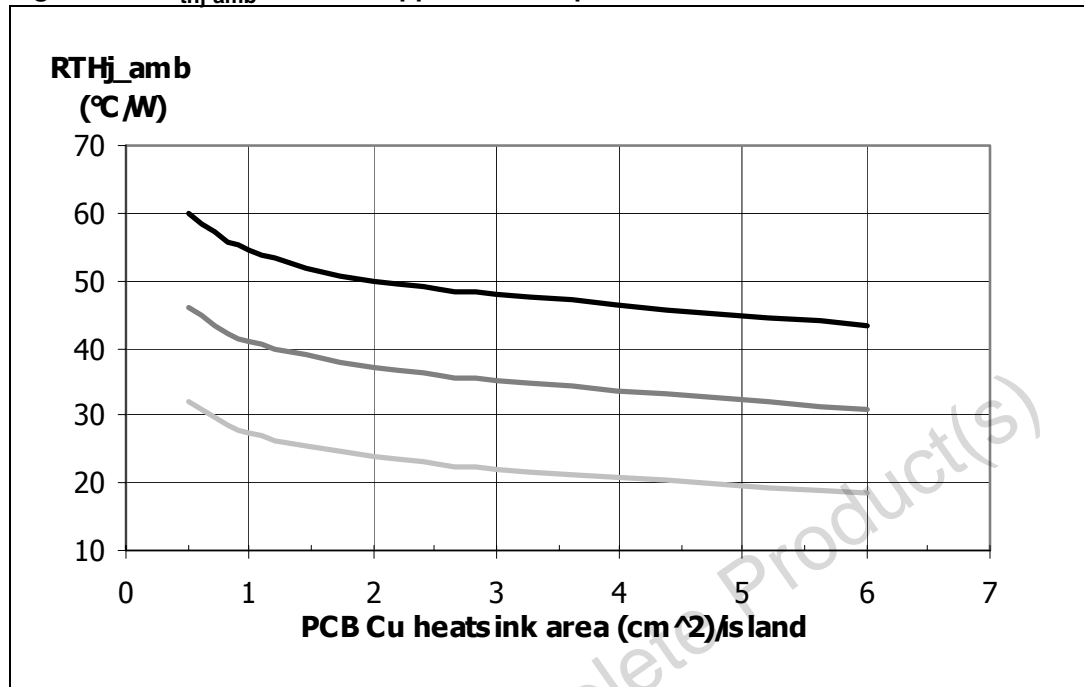
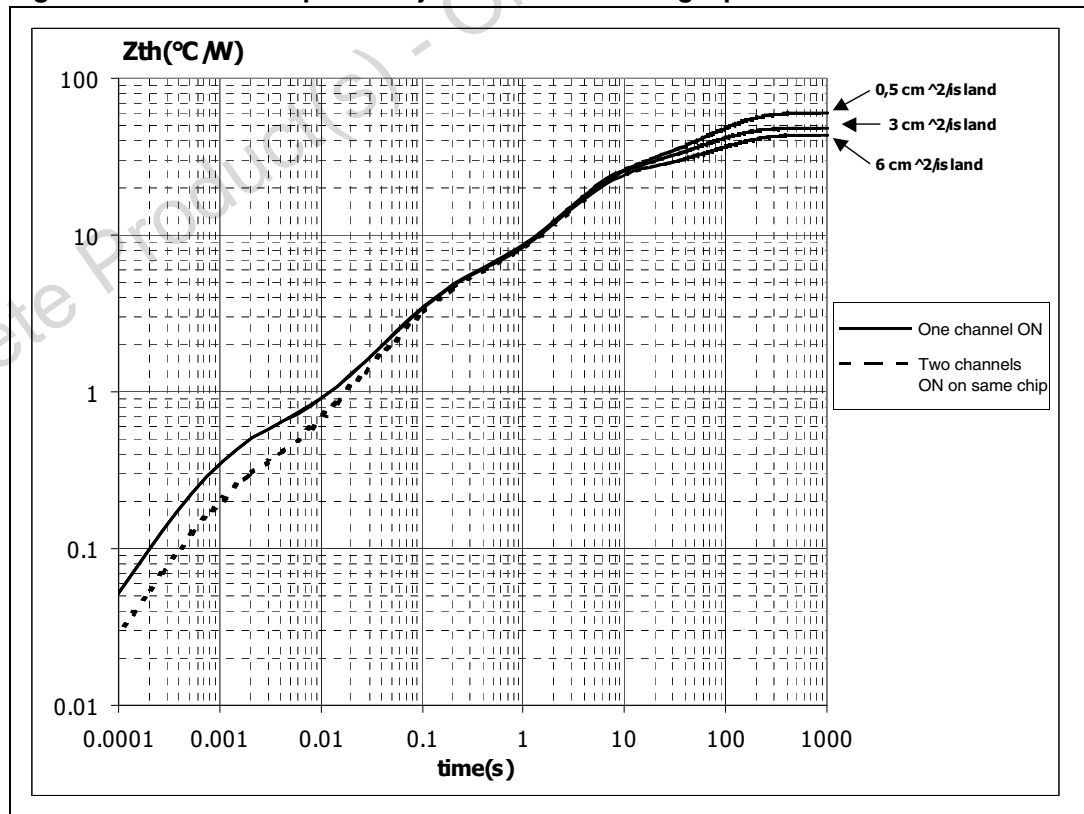

Figure 23. Thermal impedance junction ambient single pulse



Equation 1: pulse calculation formula

$$Z_{TH\delta} = R_{TH} \cdot \delta + Z_{THtp}(1 - \delta)$$

where $\delta = t_p / T$

Figure 24. Thermal fitting model of a quad channel HSD in SO-28

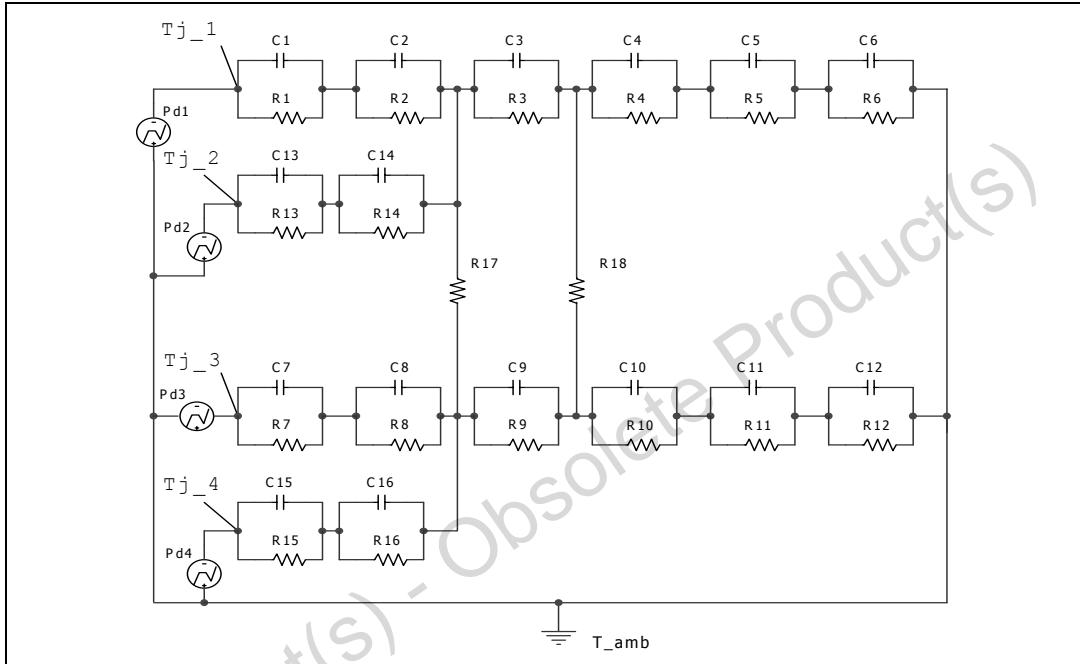

Table 14. Thermal parameters

Area/island (cm ²)	0.5	6
R1=R7=R13=R15 (°C/W)	0.05	
R2=R8=R14=R16 (°C/W)	0.3	
R3=R9 (°C/W)	3.4	
R4=R10 (°C/W)	11	
R5=R11 (°C/W)	15	
R6=R12 (°C/W)	30	13
C1=C7=C13=C15 (W.s/°C)	0.001	
C2=C8=C14=C16 (W.s/°C)	5.00E-03	
C3=C9 (W.s/°C)	1.00E-02	
C4=C10 (W.s/°C)	0.2	
C5=C11 (W.s/°C)	1.5	
C6=C12 (W.s/°C)	5	8
R17=R18 (°C/W)	150	

5 Package and packing information

5.1 ECOPACK® packages

In order to meet environmental requirements, ST offers these devices in ECOPACK® packages. These packages have a Lead-free second-level interconnect. The category of Second-Level Interconnect is marked on the package and on the inner box label, in compliance with JEDEC Standard JESD97. The maximum ratings related to soldering conditions are also marked on the inner box label. ECOPACK is an ST trademark. ECOPACK specifications are available at: www.st.com.

Figure 25. SO-28 package dimensions

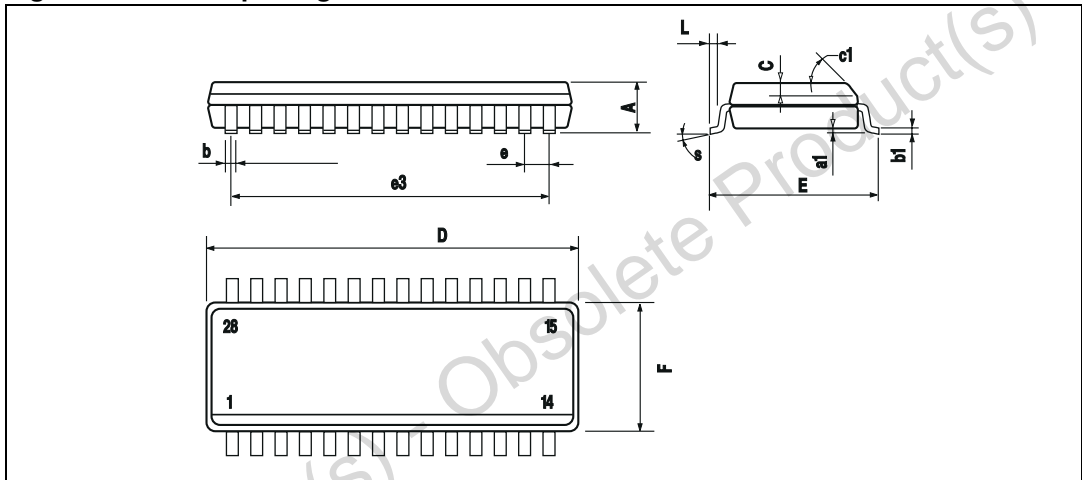

Table 15. SO-28 mechanical data

Symbol	Millimeters		
	Min.	Typ.	Max.
A			2.65
a1	0.10		0.30
b	0.35		0.49
b1	0.23		0.32
C		0.50	
c1	45° (typ.)		
D	17.7		18.1
E	10.00		10.65
e		1.27	
e3		16.51	
F	7.40		7.60
L	0.40		1.27
S	8° (max.)		

5.2 SO-28 packing information

Figure 26. SO-28 tube shipment (no suffix)

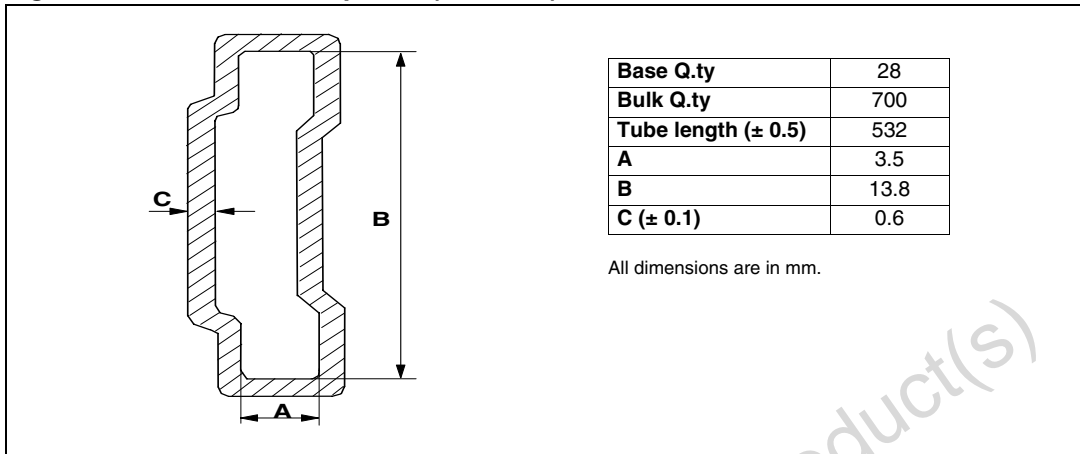
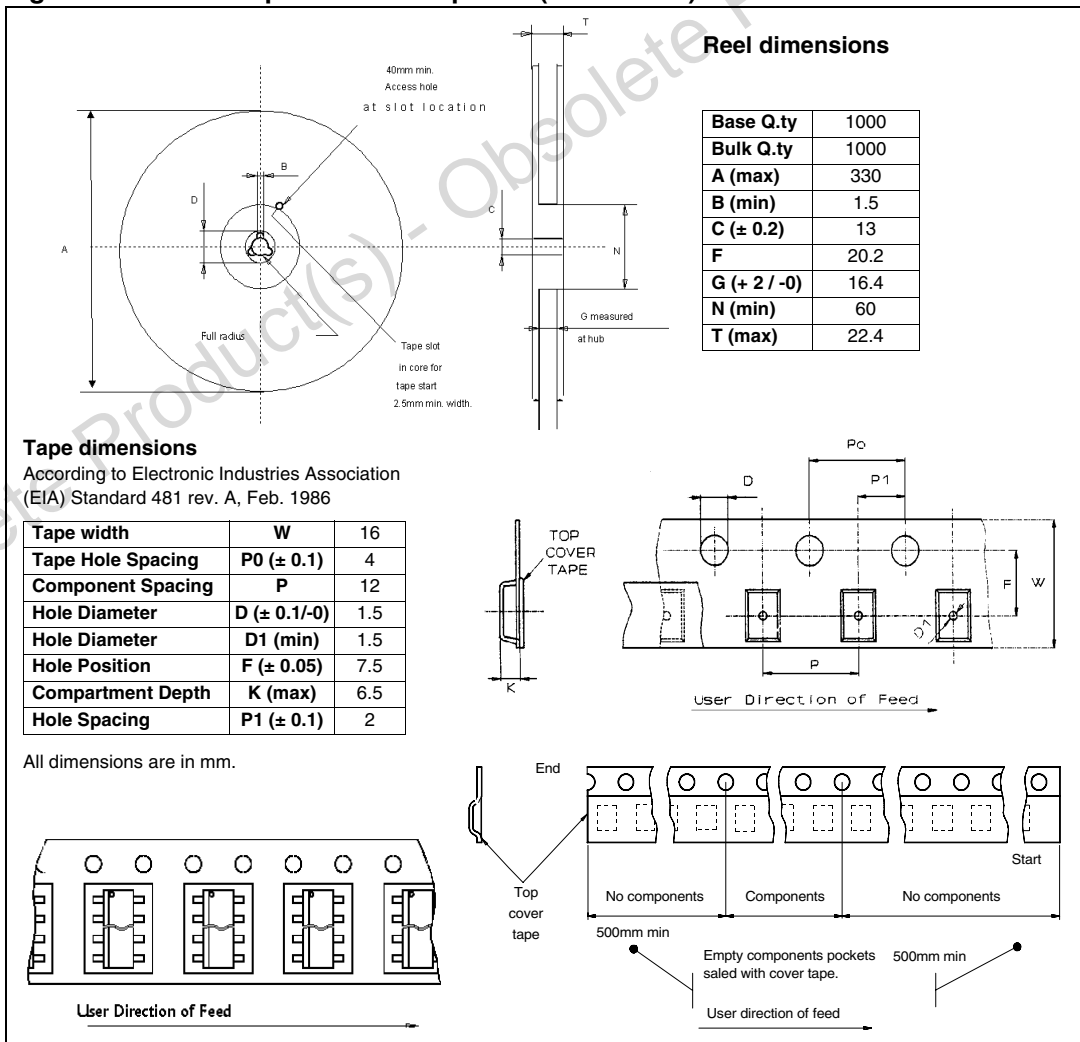

Figure 27. SO-28 tape and reel shipment (suffix "TR")



6 Revision history

Table 16. Document revision history

Date	Revision	Changes
Nov-2004	1	Initial release.
02-Jul-2004	2	Added Table 16: Document revision history .
22-Jul-2004	3	Updated disclaimer.
14-Aug-2004	4	Updated Figure 3: Current and voltage conventions .
04-Apr-2005	5	Added Figure 2.: Configuration diagram (top view) .
17-Apr-2005	6	Added Table 2: Suggested connections for unused and not connected pins .
29-May-2006	7	Updated Table 14: Thermal parameters : added 6 cm ² Cu condition.
19-Nov-2006	8	Updated Table 10: V_{CC} - output diode .
18-Jul-2007	9	Updated Table 6: Protections : added note.
11-Nov-2008	10	Document converted to corporate template.

Please Read Carefully:

Information in this document is provided solely in connection with ST products. STMicroelectronics NV and its subsidiaries ("ST") reserve the right to make changes, corrections, modifications or improvements, to this document, and the products and services described herein at any time, without notice.

All ST products are sold pursuant to ST's terms and conditions of sale.

Purchasers are solely responsible for the choice, selection and use of the ST products and services described herein, and ST assumes no liability whatsoever relating to the choice, selection or use of the ST products and services described herein.

No license, express or implied, by estoppel or otherwise, to any intellectual property rights is granted under this document. If any part of this document refers to any third party products or services it shall not be deemed a license grant by ST for the use of such third party products or services, or any intellectual property contained therein or considered as a warranty covering the use in any manner whatsoever of such third party products or services or any intellectual property contained therein.

UNLESS OTHERWISE SET FORTH IN ST'S TERMS AND CONDITIONS OF SALE ST DISCLAIMS ANY EXPRESS OR IMPLIED WARRANTY WITH RESPECT TO THE USE AND/OR SALE OF ST PRODUCTS INCLUDING WITHOUT LIMITATION IMPLIED WARRANTIES OF MERCHANTABILITY, FITNESS FOR A PARTICULAR PURPOSE (AND THEIR EQUIVALENTS UNDER THE LAWS OF ANY JURISDICTION), OR INFRINGEMENT OF ANY PATENT, COPYRIGHT OR OTHER INTELLECTUAL PROPERTY RIGHT.

UNLESS EXPRESSLY APPROVED IN WRITING BY AN AUTHORIZED ST REPRESENTATIVE, ST PRODUCTS ARE NOT RECOMMENDED, AUTHORIZED OR WARRANTED FOR USE IN MILITARY, AIR CRAFT, SPACE, LIFE SAVING, OR LIFE SUSTAINING APPLICATIONS, NOR IN PRODUCTS OR SYSTEMS WHERE FAILURE OR MALFUNCTION MAY RESULT IN PERSONAL INJURY, DEATH, OR SEVERE PROPERTY OR ENVIRONMENTAL DAMAGE. ST PRODUCTS WHICH ARE NOT SPECIFIED AS "AUTOMOTIVE GRADE" MAY ONLY BE USED IN AUTOMOTIVE APPLICATIONS AT USER'S OWN RISK.

Resale of ST products with provisions different from the statements and/or technical features set forth in this document shall immediately void any warranty granted by ST for the ST product or service described herein and shall not create or extend in any manner whatsoever, any liability of ST.

ST and the ST logo are trademarks or registered trademarks of ST in various countries.

Information in this document supersedes and replaces all information previously supplied.

The ST logo is a registered trademark of STMicroelectronics. All other names are the property of their respective owners.

© 2008 STMicroelectronics - All rights reserved

STMicroelectronics group of companies

Australia - Belgium - Brazil - Canada - China - Czech Republic - Finland - France - Germany - Hong Kong - India - Israel - Italy - Japan - Malaysia - Malta - Morocco - Singapore - Spain - Sweden - Switzerland - United Kingdom - United States of America

www.st.com

Mouser Electronics

Authorized Distributor

Click to View Pricing, Inventory, Delivery & Lifecycle Information:

[STMicroelectronics:](#)

[VNQ60013TR](#) [VNQ600TR-E](#) [VNQ600](#) [VNQ600-E](#)