



92x92x25 mm

San Ace 92W 9WL type   

General Specifications

- Material Frame: Aluminum (Black coating), Impeller: Plastic (Flammability: UL 94V-1)
- Expected life See the table below. (L10 life: 90% survival rate for continuous operation in indoor free air at 60°C, rated voltage)
- Motor protection function Locked rotor burnout protection, Reverse polarity protection
For details, please refer to p. 529.
- Dielectric strength 50/60 Hz, 500 VAC, for 1 minute (between lead wire conductors and frame)
- Insulation resistance 10 MΩ or more with a 500 VDC megger (between lead wire conductors and frame)
- Sound pressure level (SPL) At 1 m away from the air inlet
- Storage temperature -30 to +70°C (Non-condensing)
- Lead wire ⊕Red ⊖Black (Sensor) Yellow (Control) Brown
- Mass 170 g
- Ingress protection IP68

Specifications

The models listed below **have pulse sensors with PWM control function.**

Model no.	Rated voltage [V]	Operating voltage range [V]	PWM duty cycle* [%]	Rated current [A]	Rated input [W]	Rated speed [min ⁻¹]	Max. airflow [m ³ /min] [CFM]	Max. static pressure [Pa] [inchH ₂ O]	SPL [dB (A)]	Operating temperature [°C]	Expected life [h]		
9WL0912P4J001	12	10.8 to 13.2	100	0.42	5.04	5000	2.2 77.7	105 0.42	44	-20 to +70	180000/60°C		
			20	0.04	0.48	1200	0.52 18.4	6.04 0.024	11				
9WL0912P4G001			100	0.3	3.6	4400	1.93 68.2	81 0.33	40				
			20	0.04	0.48	1000	0.43 15.1	4.18 0.016	8				
9WL0912P4S001			100	0.22	2.64	3850	1.69 59.7	62.1 0.25	37				
			30	0.04	0.48	1400	0.61 21.5	8.21 0.032	13				
9WL0912P4H001			100	0.15	1.8	3150	1.38 48.7	41.6 0.17	32				
			30	0.04	0.48	1100	0.48 16.9	5.07 0.02	9				
9WL0924P4J001			24	21.6 to 26.4	100	0.21	5.04	5000	2.2 77.7			105 0.42	44
					20	0.02	0.48	1100	0.48 16.9			5.07 0.02	9
9WL0924P4S001					100	0.11	2.64	3850	1.69 59.7			62.1 0.25	37
					30	0.02	0.48	1300	0.57 20.1			7.08 0.028	12
9WL0924P4H001	100	0.07			1.68	3150	1.38 48.7	41.6 0.17	32				
	30	0.02			0.48	1000	0.43 15.1	4.18 0.016	8				

* PWM frequency: 25 kHz. Fan does not rotate when PWM duty cycle is 0%.

Other sensor specifications are available as options. Refer to the index (p. 559).

Airflow - Static Pressure Characteristics / PWM Duty - Speed Characteristics Example

9WL0912P4J001 With pulse sensor with PWM control function

PWM duty cycle

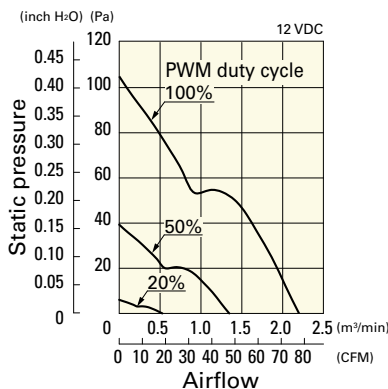

Operating voltage range

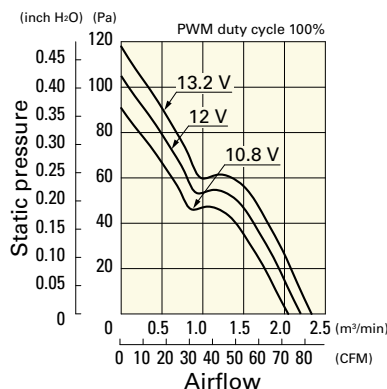

PWM duty - Speed characteristics example

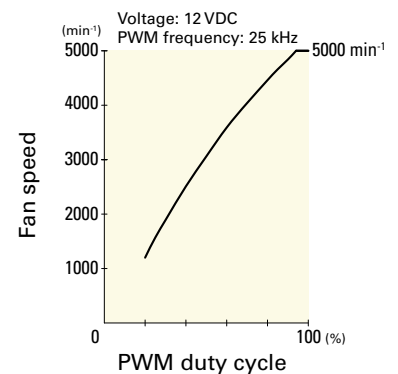

Airflow - Static Pressure Characteristics / PWM Duty - Speed Characteristics Example

9WL0912P4G001 With pulse sensor with PWM control function

PWM duty cycle

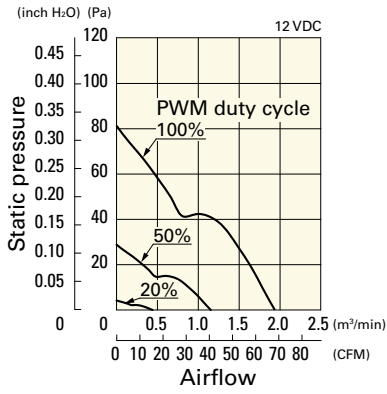

Operating voltage range

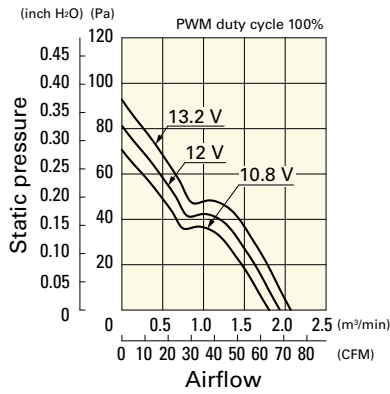

PWM duty - Speed characteristics example

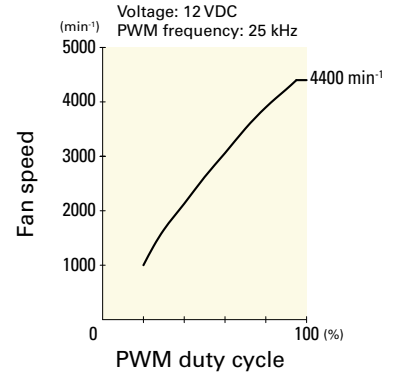

9WL0912P4S001 With pulse sensor with PWM control function

PWM duty cycle

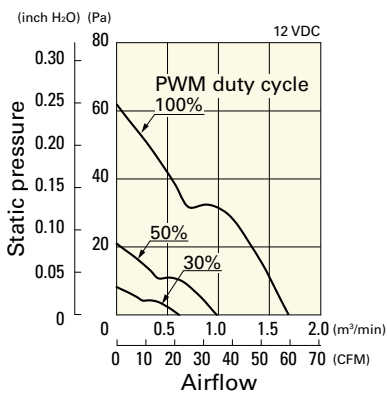

Operating voltage range

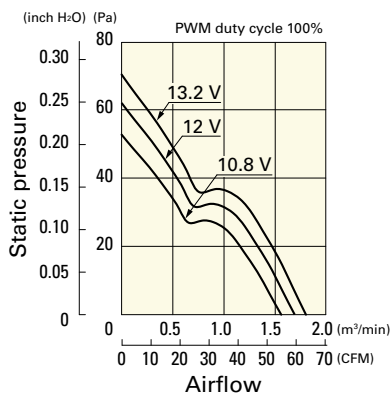

PWM duty - Speed characteristics example

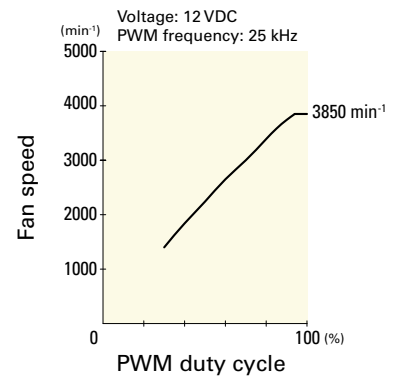

9WL0912P4H001 With pulse sensor with PWM control function

PWM duty cycle

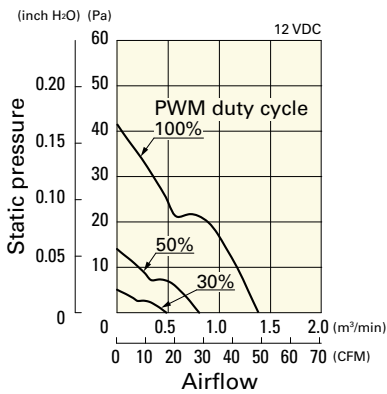

Operating voltage range

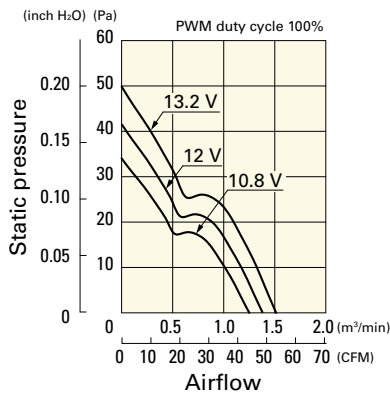

PWM duty - Speed characteristics example

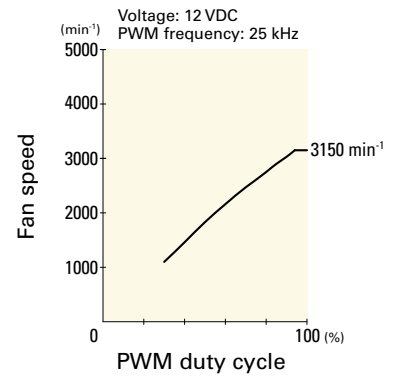

9WL0924P4J001 With pulse sensor with PWM control function

PWM duty cycle

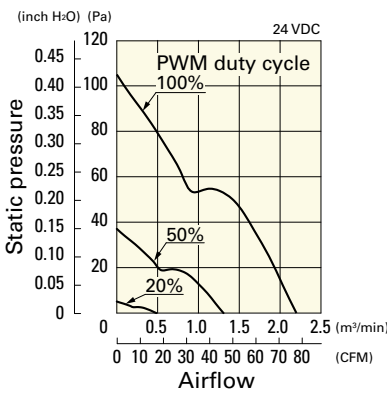

Operating voltage range

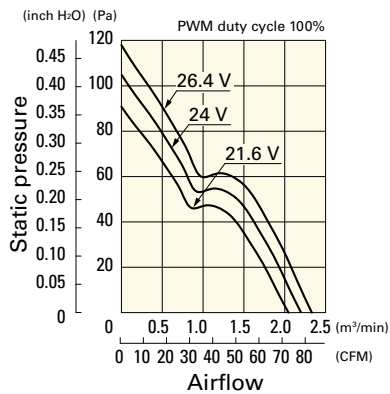

PWM duty - Speed characteristics example

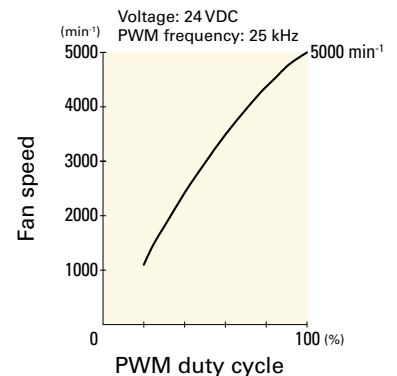

DC
Splash Proof Fan 92 mm sq.

Airflow - Static Pressure Characteristics / PWM Duty - Speed Characteristics Example

9WL0924P4S001 With pulse sensor with PWM control function

PWM duty cycle

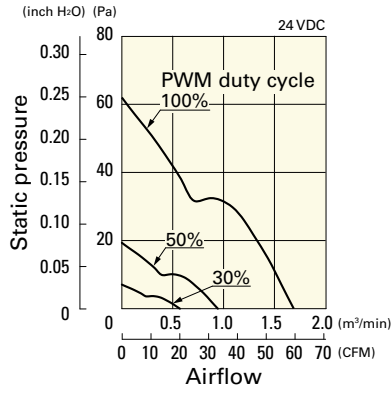

Operating voltage range

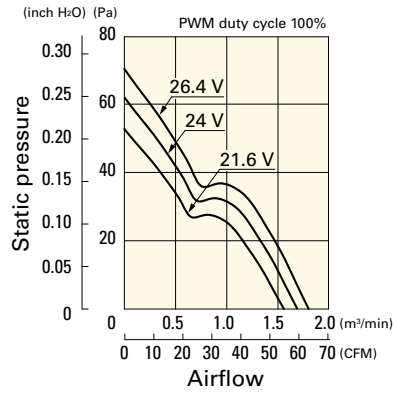

PWM duty - Speed characteristics example

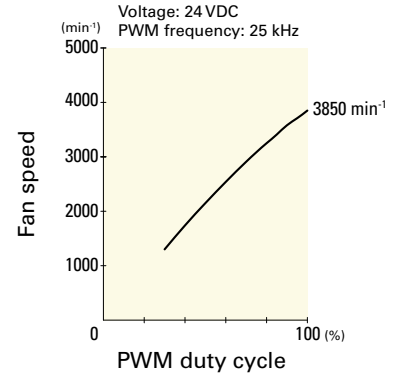

9WL0924P4H001 With pulse sensor with PWM control function

PWM duty cycle

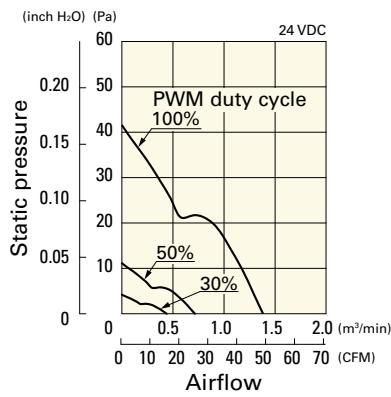

Operating voltage range

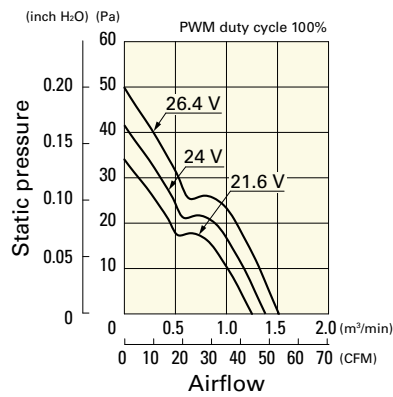

PWM duty - Speed characteristics example

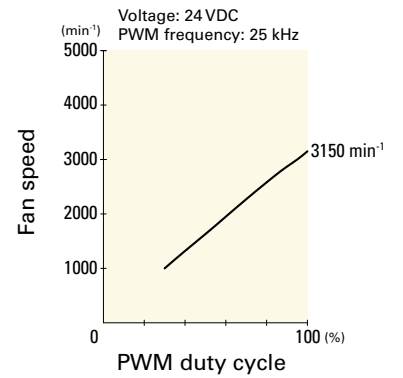

Dimensions (unit: mm)

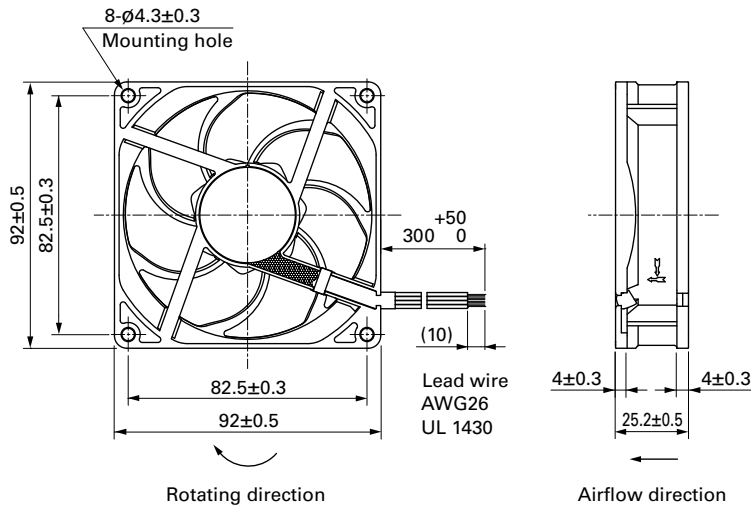

Reference Dimensions of Mounting Holes and Vent Opening (unit: mm)

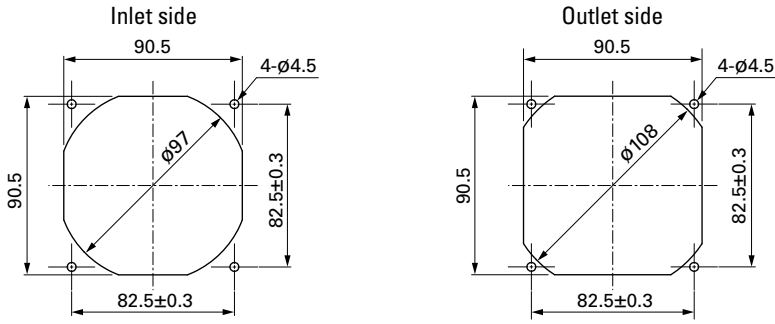

Options

Finger guards

page: p. 513

Model no.: 109-099C, 109-099E, 109-099H

Resin finger guards

page: p. 520

Model no.: 109-1001G

Mouser Electronics

Authorized Distributor

Click to View Pricing, Inventory, Delivery & Lifecycle Information:

Sanyo Denki:

[9WL0924P4S001](#) [9WL0912P4J001](#) [9WL0912P4G001](#) [9WL0912P4H001](#) [9WL0924P4H001](#) [9WL0912P4S001](#)
[9WL0924P4J001](#) [9WL0912J4002](#)