



Please note that Cypress is an Infineon Technologies Company.

The document following this cover page is marked as “Cypress” document as this is the company that originally developed the product. Please note that Infineon will continue to offer the product to new and existing customers as part of the Infineon product portfolio.

Continuity of document content

The fact that Infineon offers the following product as part of the Infineon product portfolio does not lead to any changes to this document. Future revisions will occur when appropriate, and any changes will be set out on the document history page.

Continuity of ordering part numbers

Infineon continues to support existing part numbers. Please continue to use the ordering part numbers listed in the datasheet for ordering.



THIS SPEC IS OBSOLETE

Spec No: 38-05256

Spec Title: CY7C1061AV33, 16-MBIT (1M X 16) STATIC
RAM

Replaced by: None

Features

- High speed
 - $t_{AA} = 10 \text{ ns}$
- Low active power
 - 990 mW (max)
- Operating voltages of $3.3 \pm 0.3 \text{ V}$
- 2.0 V data retention
- Automatic power down when deselected
- TTL compatible inputs and outputs
- Easy memory expansion with \overline{CE}_1 and CE_2 features
- Available in Pb-free and non Pb-free 54-pin TSOP II package and non Pb-free 60-ball fine-pitch ball grid array (FBGA) package

Functional Description

The CY7C1061AV33 is a high performance CMOS Static RAM organized as 1,048,576 words by 16 bits.

To write to the device, enable the chip (\overline{CE}_1 LOW and CE_2 HIGH) while forcing the Write Enable (\overline{WE}) input LOW. If Byte Low Enable (\overline{BLE}) is LOW, then data from I/O pins (I/O_0 through I/O_7), is written into the location specified on the address pins (A_0 through A_{19}). If Byte High Enable (\overline{BHE}) is LOW, then data from I/O pins (I/O_8 through I/O_{15}) is written into the location specified on the address pins (A_0 through A_{19}).

To read from the device, enable the chip by taking \overline{CE}_1 LOW and CE_2 HIGH while forcing the Output Enable (\overline{OE}) LOW and the Write Enable (\overline{WE}) HIGH. If Byte Low Enable (\overline{BLE}) is LOW, then data from the memory location specified by the address pins will appear on I/O_0 to I/O_7 . If Byte High Enable (\overline{BHE}) is LOW, then data from memory will appear on I/O_8 to I/O_{15} . See Truth Table on page 11 for a complete description of Read and Write modes.

The input/output pins (I/O_0 through I/O_{15}) are placed in a high-impedance state when the device is deselected (\overline{CE}_1 HIGH/ CE_2 LOW), the outputs are disabled (\overline{OE} HIGH), the \overline{BHE} and \overline{BLE} are disabled (\overline{BHE} , \overline{BLE} HIGH), or a Write operation is in progress (\overline{CE}_1 LOW, CE_2 HIGH, and \overline{WE} LOW).

For a complete list of related documentation, click [here](#).

Logic Block Diagram

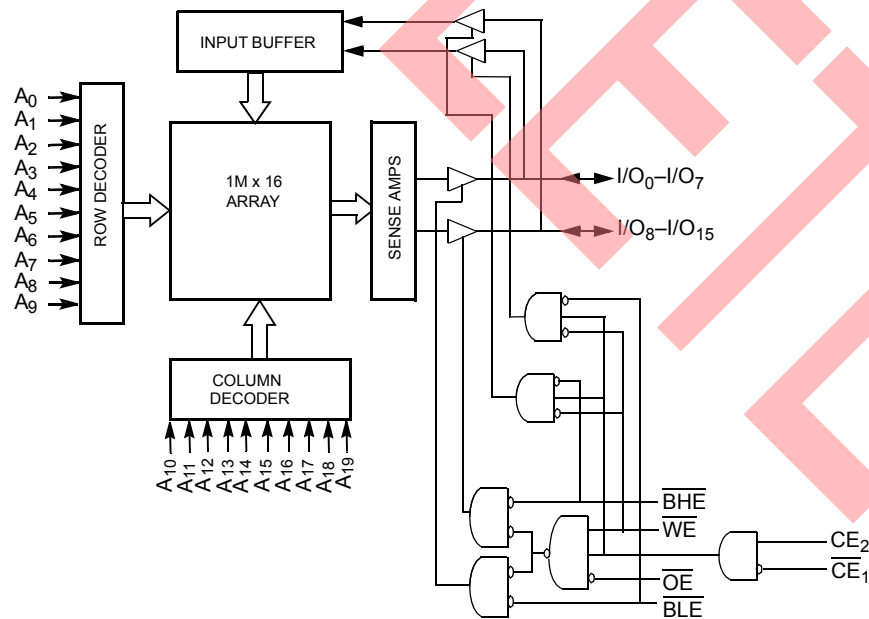

Contents

Selection Guide	3	Package Diagrams	13
Pin Configurations	3	Acronyms	15
Maximum Ratings	5	Document Conventions	15
Operating Range	5	Units of Measure	15
DC Electrical Characteristics	5	Document History Page	16
Capacitance	6	Sales, Solutions, and Legal Information	17
AC Test Loads and Waveforms	6	Worldwide Sales and Design Support	17
Data Retention Waveform	6	Products	17
AC Switching Characteristics	7	PSoC® Solutions	17
Switching Waveforms	8	Cypress Developer Community	17
Truth Table	11	Technical Support	17
Ordering Information	12		
Ordering Code Definitions	12		

Selection Guide

Description		-10	Unit
Maximum Access Time		10	ns
Maximum Operating Current	Commercial	275	mA
	Industrial	275	
Maximum CMOS Standby Current	Commercial / Industrial	50	mA

Pin Configurations

Figure 1. 60-ball FBGA pinout (Top View) [1, 2]

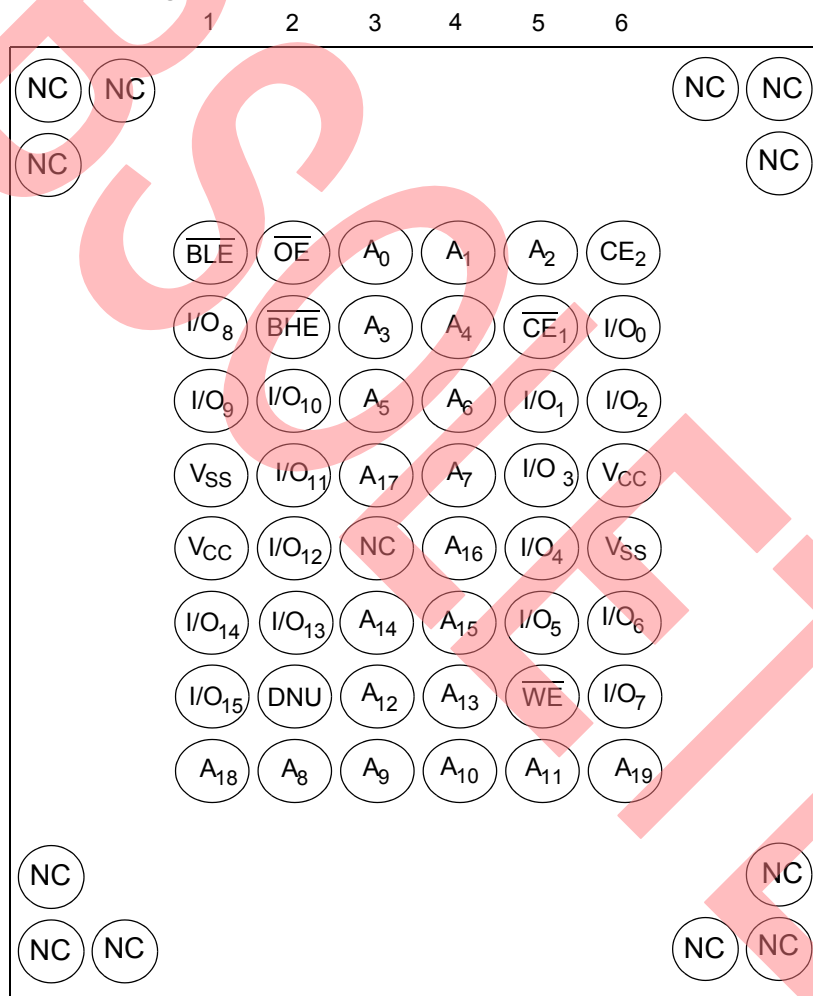

Notes

1. NC pins are not connected on the die.
2. DNU (Do Not Use) pins have to be left floating or tied to VSS to ensure proper operation.

Pin Configurations (continued)

Figure 2. 54-pin TSOP II pinout (Top View) [3, 4]

I/O ₁₂	1	54	I/O ₁₁
V _{CC}	2	53	V _{SS}
I/O ₁₃	3	52	I/O ₁₀
I/O ₁₄	4	51	I/O ₉
V _{SS}	5	50	V _{CC}
I/O ₁₅	6	49	I/O ₈
A ₄	7	48	A ₅
A ₃	8	47	A ₆
A ₂	9	46	A ₇
A ₁	10	45	A ₈
A ₀	11	44	A ₉
<u>BHE</u>	12	43	NC
CE ₁	13	42	OE
V _{CC}	14	41	V _{SS}
<u>WE</u>	15	40	DNU
CE ₂	16	39	BLE
A ₁₉	17	38	A ₁₀
A ₁₈	18	37	A ₁₁
A ₁₇	19	36	A ₁₂
A ₁₆	20	35	A ₁₃
A ₁₅	21	34	A ₁₄
I/O ₁	22	33	I/O ₇
V _{CC}	23	32	V _{SS}
I/O ₁	24	31	I/O ₆
I/O ₂	25	30	I/O ₅
V _{SS}	26	29	V _{CC}
I/O ₃	27	28	I/O ₄

Notes

3. NC pins are not connected on the die.
4. DNU (Do Not Use) pins have to be left floating or tied to VSS to ensure proper operation.

Maximum Ratings

Exceeding maximum ratings may shorten the useful life of the device. These user guidelines are not tested.

Storage Temperature -65 °C to +150 °C
 Ambient Temperature with Power Applied -55 °C to +125 °C
 Supply Voltage on V_{CC} to Relative GND [5] -0.5 V to +4.6 V
 DC Voltage Applied to Outputs in High Z State [5] -0.5 V to $V_{CC} + 0.5$ V

DC Input Voltage [5] -0.5 V to $V_{CC} + 0.5$ V
 Current into Outputs (LOW) 20 mA

Operating Range

Range	Ambient Temperature	V_{CC}
Commercial	0 °C to +70 °C	3.3 V ± 0.3 V
Industrial	-40 °C to +85 °C	

DC Electrical Characteristics

Over the Operating Range

Parameter	Description	Test Conditions	-10		Unit	
			Min	Max		
V_{OH}	Output HIGH Voltage	$I_{OH} = -4.0$ mA	2.4	-	V	
V_{OL}	Output LOW Voltage	$I_{OL} = 8.0$ mA	-	0.4	V	
V_{IH}	Input HIGH Voltage		2.0	$V_{CC} + 0.3$	V	
V_{IL}	Input LOW Voltage [5]		-0.3	0.8	V	
I_{IX}	Input Leakage Current	$GND \leq V_I \leq V_{CC}$	-1	+1	μA	
I_{OZ}	Output Leakage Current	$GND \leq V_O \leq V_{CC}$, Output Disabled	-1	+1	μA	
I_{CC}	V_{CC} Operating Supply Current	$V_{CC} = \max$, $f = f_{max} = 1/t_{RC}$	Commercial	-	275	mA
			Industrial	-	275	mA
I_{SB1}	Automatic CE Power-down Current – TTL Inputs	$CE_2 \leq V_{IL}$, Max V_{CC} , $\overline{CE} \geq V_{IH}$, $V_{IN} \geq V_{IH}$ or $V_{IN} \leq V_{IL}$, $f = f_{max}$	-	70	mA	
I_{SB2}	Automatic CE Power-down Current – CMOS Inputs	$CE_2 \leq 0.3$ V, Max V_{CC} , $\overline{CE} \geq V_{CC} - 0.3$ V, $V_{IN} \geq V_{CC} - 0.3$ V, or $V_{IN} \leq 0.3$ V, $f = 0$	-	50	mA	

Note

5. $V_{IL}(\min) = -2.0$ V for pulse durations of less than 20 ns.

Capacitance

Parameter [6]	Description	Test Conditions	TSOP II	FBGA	Unit
C_{IN}	Input capacitance	$T_A = 25\text{ }^\circ\text{C}$, $f = 1\text{ MHz}$, $V_{CC} = 3.3\text{ V}$	6	8	pF
C_{OUT}	I/O capacitance		8	10	pF

AC Test Loads and Waveforms

Figure 3. AC Test Loads and Waveforms [7]

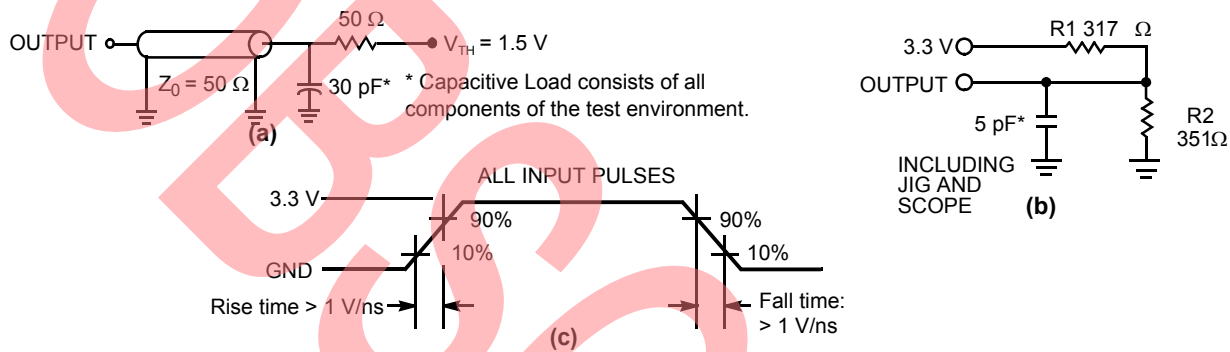

Data Retention Waveform

Figure 4. Data Retention Waveform

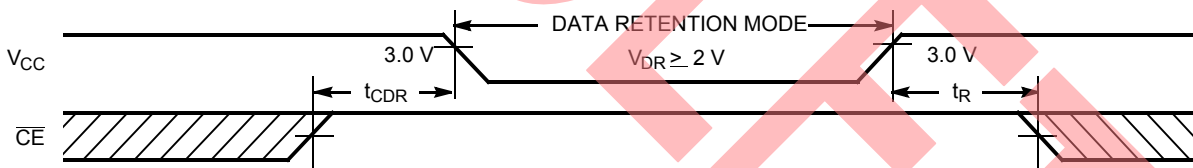

Notes

- 6. Tested initially and after any design or process changes that may affect these parameters.
- 7. Valid SRAM operation does not occur until the power supplies have reached the minimum operating V_{DD} (3.0 V). As soon as 1 ms (T_{power}) after reaching the minimum operating V_{DD} , normal SRAM operation can begin including reduction in V_{DD} to the data retention (V_{CCDR} , 2.0 V) voltage.

AC Switching Characteristics

Over the Operating Range

Parameter [8]	Description	-10		Unit
		Min	Max	
Read Cycle				
t_{power}	V_{CC} (typical) to the first access [9]	1	–	ms
t_{RC}	Read Cycle Time	10	–	ns
t_{AA}	Address to Data Valid	–	10	ns
t_{OHA}	Data Hold from Address Change	3	–	ns
t_{ACE}	\overline{CE}_1 LOW/ CE_2 HIGH to Data Valid	–	10	ns
t_{DOE}	\overline{OE} LOW to Data Valid	–	5	ns
t_{LZOE}	\overline{OE} LOW to Low Z	1	–	ns
t_{HZOE}	\overline{OE} HIGH to High Z [10]	–	5	ns
t_{LZCE}	\overline{CE}_1 LOW/ CE_2 HIGH to Low Z [10]	3	–	ns
t_{HZCE}	\overline{CE}_1 HIGH/ CE_2 LOW to High Z [10]	–	5	ns
t_{PU}	\overline{CE}_1 LOW/ CE_2 HIGH to Power Up [11]	0	–	ns
t_{PD}	\overline{CE}_1 HIGH/ CE_2 LOW to Power Down [11]	–	10	ns
t_{DBE}	Byte Enable to Data Valid	–	5	ns
t_{LZBE}	Byte Enable to Low Z	1	–	ns
t_{HZBE}	Byte Disable to High Z	–	5	ns
Write Cycle [12, 13]				
t_{WC}	Write Cycle Time	10	–	ns
t_{SCE}	\overline{CE}_1 LOW/ CE_2 HIGH to Write End	7	–	ns
t_{AW}	Address Setup to Write End	7	–	ns
t_{HA}	Address Hold from Write End	0	–	ns
t_{SA}	Address Setup to Write Start	0	–	ns
t_{PWE}	\overline{WE} Pulse Width	7	–	ns
t_{SD}	Data Setup to Write End	5.5	–	ns
t_{HD}	Data Hold from Write End	0	–	ns
t_{LZWE}	\overline{WE} HIGH to Low Z [10]	3	–	ns
t_{HZWE}	\overline{WE} LOW to High Z [10]	–	5	ns
t_{BW}	Byte Enable to End of Write	7	–	ns

Notes

- Test conditions assume signal transition time of 3 ns or less, timing reference levels of 1.5 V, input pulse levels of 0 to 3.0 V, and output loading of the specified I_{OL}/I_{OH} and specified transmission line loads. Test conditions for the Read cycle use output loading shown in (a) of the Figure 3 on page 6, unless specified otherwise.
- This part has a voltage regulator that steps down the voltage from 3 V to 2 V internally. t_{power} time must be provided initially before a Read/Write operation is started.
- t_{HZOE} , t_{HZCE} , t_{HZWE} , t_{HZBE} and t_{LZOE} , t_{LZCE} , t_{LZWE} , t_{LZBE} are specified with a load capacitance of 5 pF as in (b) of Figure 3 on page 6. Transition is measured ± 200 mV from steady-state voltage.
- These parameters are guaranteed by design and are not tested.
- The internal Write time of the memory is defined by the overlap of \overline{CE}_1 LOW (CE_2 HIGH) and \overline{WE} LOW. Chip enables must be active and \overline{WE} and byte enables must be LOW to initiate a Write, and the transition of any of these signals can terminate the Write. The input data setup and hold timing should be referenced to the leading edge of the signal that terminates the Write.
- The minimum Write cycle time for Write Cycle No. 2 (\overline{WE} controlled, \overline{OE} LOW) should be equal to the sum of t_{SD} and t_{HZWE} .

Switching Waveforms

Figure 5. Read Cycle No. 1 (Address Transition Controlled) [14, 15]

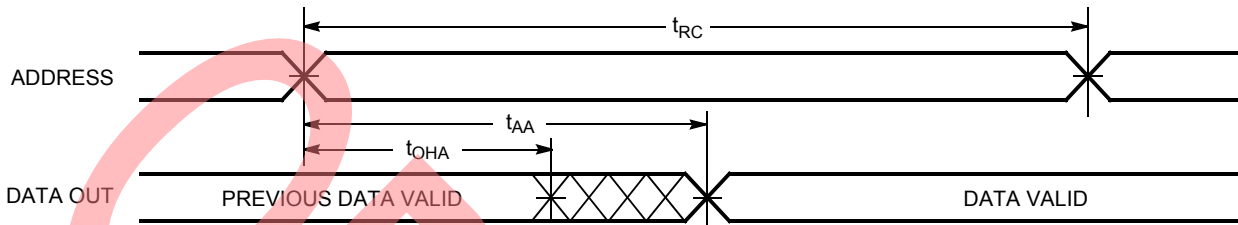
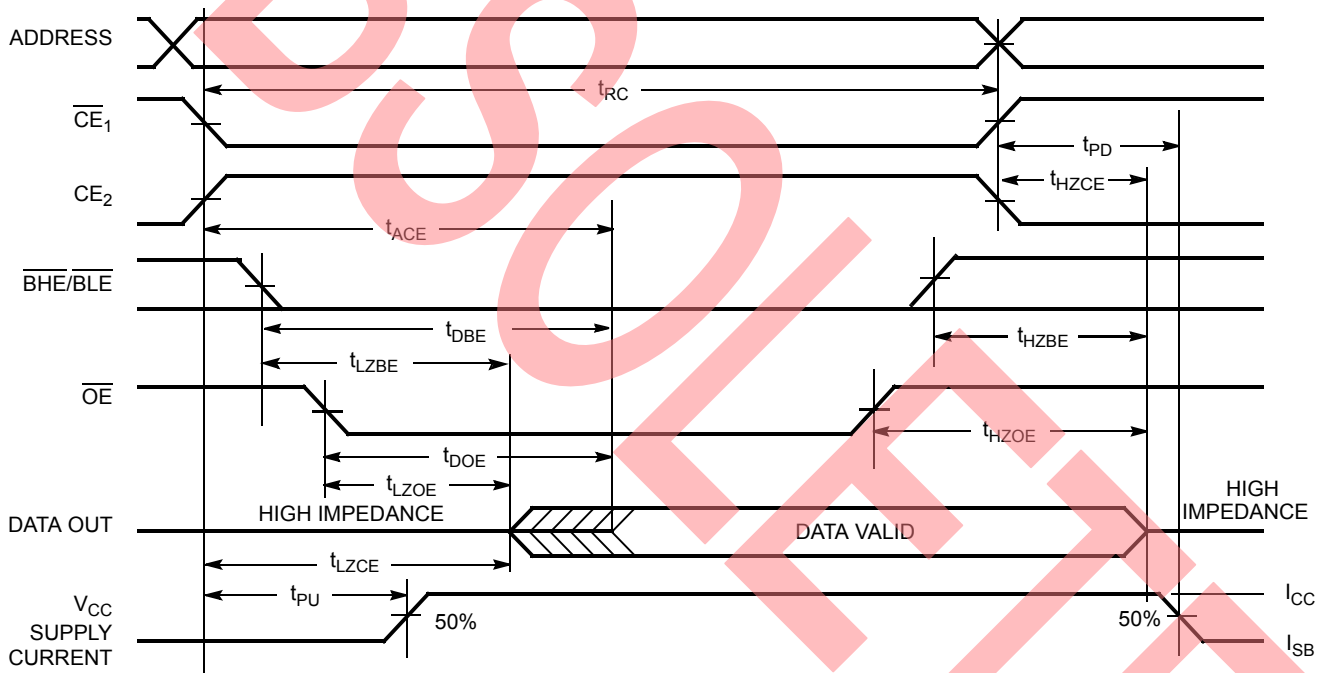

Figure 6. Read Cycle No. 2 (\overline{OE} Controlled) [15, 16]



Notes

- 14. Device is continuously selected. \overline{OE} , \overline{CE} , \overline{BHE} or \overline{BLE} , or both = V_{IL} . $CE_2 = V_{IH}$.
- 15. \overline{WE} is HIGH for Read cycle.
- 16. Address valid prior to or coincident with \overline{CE}_1 transition LOW and CE_2 transition HIGH.

Switching Waveforms (continued)

Figure 7. Write Cycle No. 1 (\overline{CE}_1 or CE_2 Controlled) [17, 18]

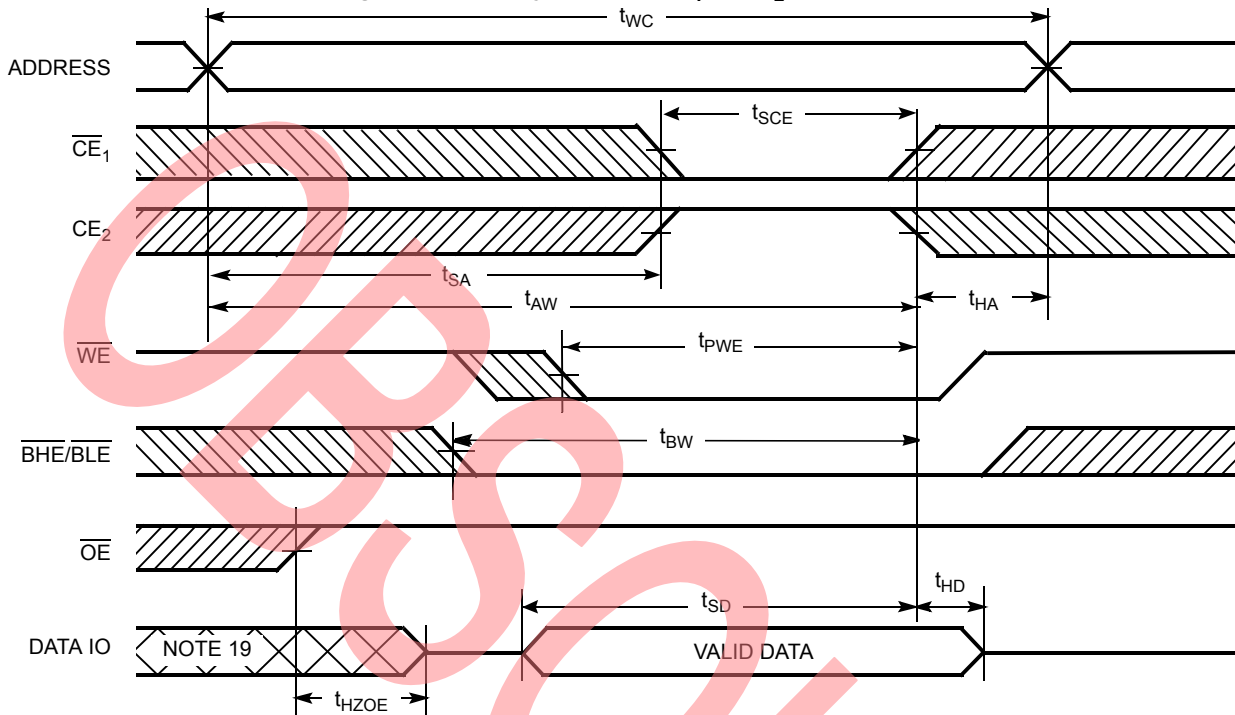
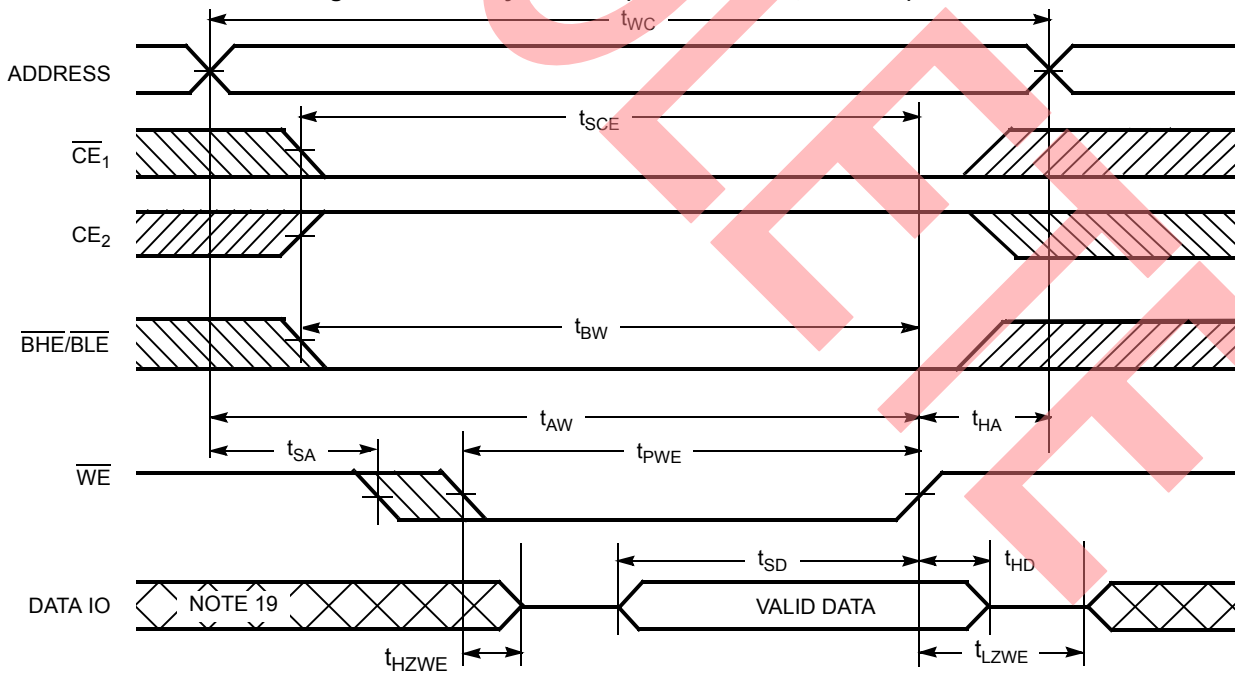

Figure 8. Write Cycle No. 2 (\overline{WE} Controlled, \overline{OE} LOW) [17, 18, 20]



Notes

- 17. Data IO is high impedance if \overline{OE} , or \overline{BHE} or \overline{BLE} or both = V_{IH} .
- 18. If \overline{CE}_1 goes HIGH simultaneously with \overline{WE} going HIGH, the output remains in a high impedance state.
- 19. During this period, the IOs are in output state and input signals should not be applied.
- 20. The minimum write cycle pulse width should be equal to the sum of t_{SD} and t_{HZWE} .

Switching Waveforms (continued)

Figure 9. Write Cycle No. 3 ($\overline{\text{BHE}}/\overline{\text{BLE}}$ Controlled)

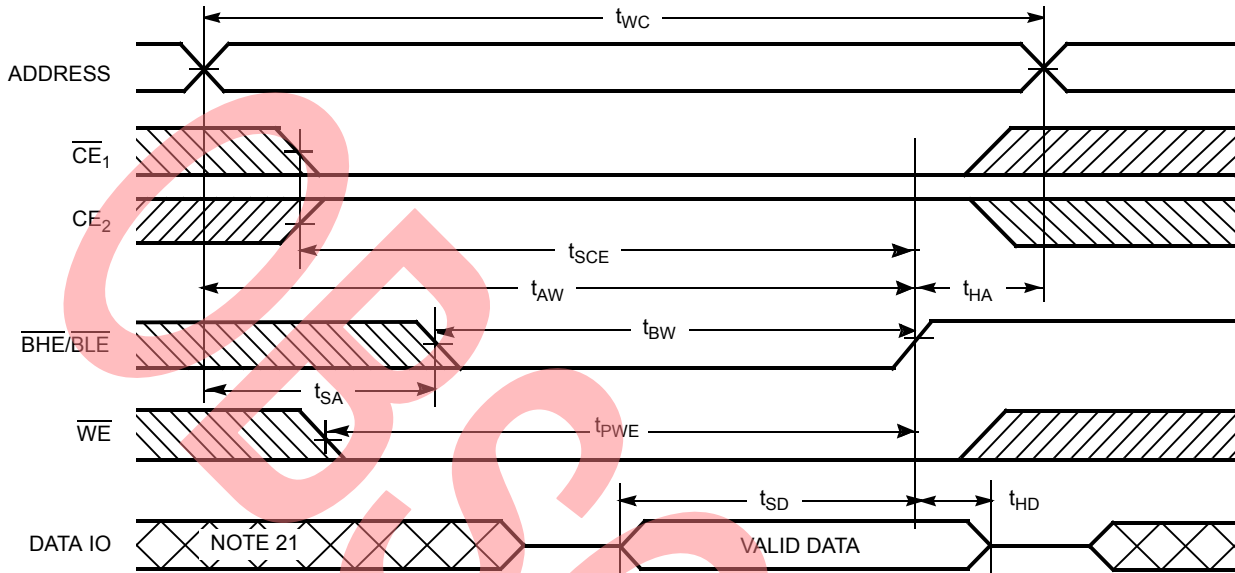

Note
21. During this period, the IOs are in output state and input signals should not be applied.

Truth Table

\overline{CE}_1	CE_2	\overline{OE}	\overline{WE}	\overline{BLE}	\overline{BHE}	I/O ₀ –I/O ₇	I/O ₈ –I/O ₁₅	Mode	Power
H	X	X	X	X	X	High Z	High Z	Power Down	Standby (I _{SB})
X	L	X	X	X	X	High Z	High Z	Power Down	Standby (I _{SB})
L	H	L	H	L	L	Data Out	Data Out	Read All Bits	Active (I _{CC})
L	H	L	H	L	H	Data Out	High Z	Read Lower Bits Only	Active (I _{CC})
L	H	L	H	H	L	High Z	Data Out	Read Upper Bits Only	Active (I _{CC})
L	H	X	L	L	L	Data In	Data In	Write All Bits	Active (I _{CC})
L	H	X	L	L	H	Data In	High Z	Write Lower Bits Only	Active (I _{CC})
L	H	X	L	H	L	High Z	Data In	Write Upper Bits Only	Active (I _{CC})
L	H	H	H	X	X	High Z	High Z	Selected, Outputs Disabled	Active (I _{CC})

Ordering Information

The following table lists the CY7C1061AV33 key package features and ordering codes. The table contains only the parts that are currently available. If you do not see what you are looking for, contact your local sales representative. For more information, visit the Cypress website at www.cypress.com and refer to the product summary page at <http://www.cypress.com/products>.

Speed (ns)	Ordering Code	Package Diagram	Package Type	Operating Range
10	CY7C1061AV33-10ZXC	51-85160	54-pin TSOP II (Pb-free)	Commercial
	CY7C1061AV33-10ZXI	51-85160	54-pin TSOP II (Pb-free)	Industrial
	CY7C1061AV33-10BAXI	51-85162	60-ball FBGA (Pb-free)	

Ordering Code Definitions

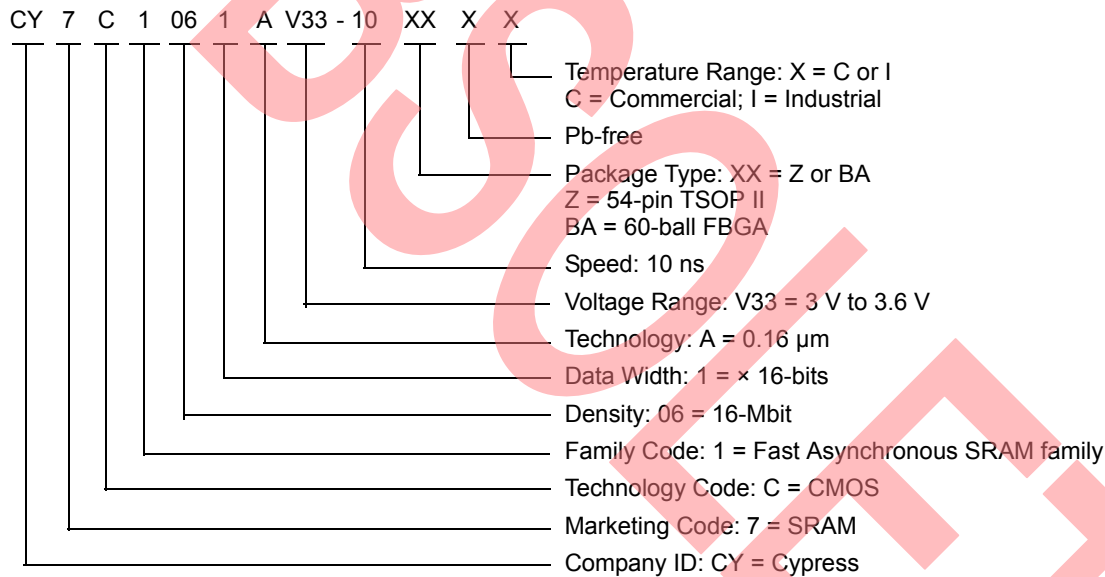

Package Diagrams

Figure 10. 54-pin TSOP II (22.4 × 11.84 × 1.0 mm) Package Outline, 51-85160

54 Lead TSOP TYPE II – STANDARD

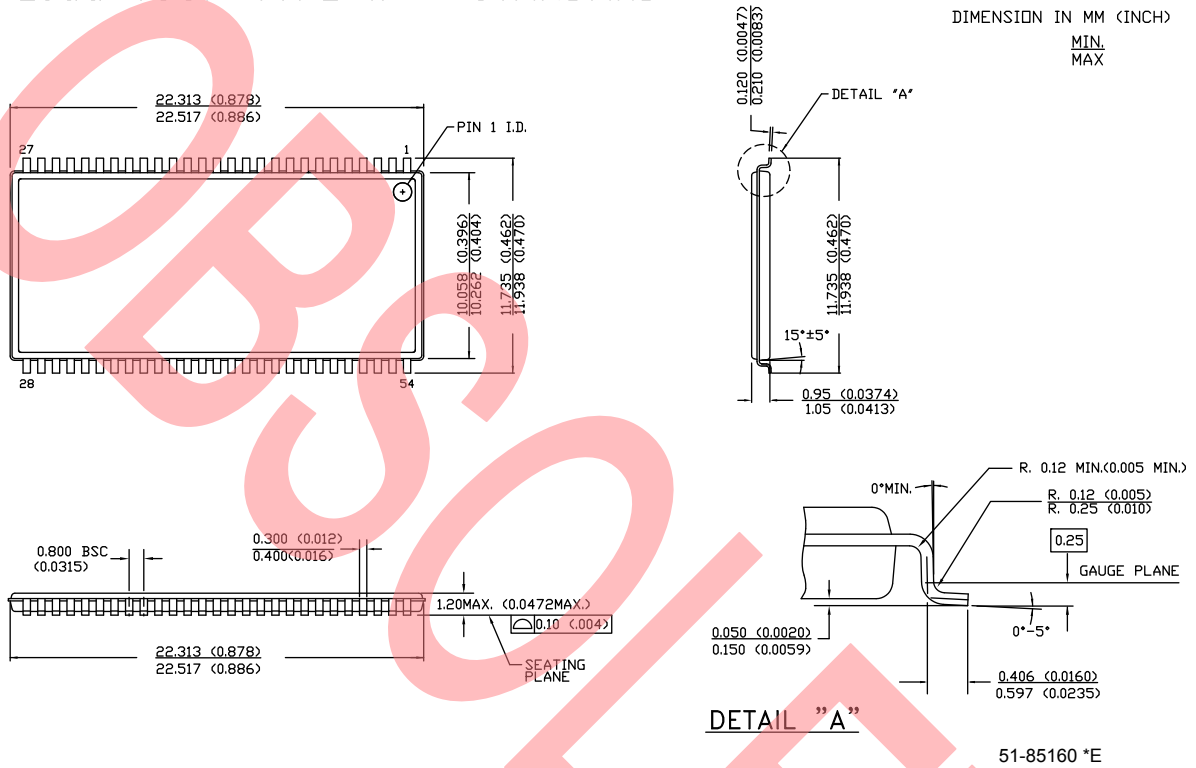

Package Diagrams (continued)

Figure 11. 60-ball FBGA (8 × 20 × 1.2 mm) Package Outline, 51-85162

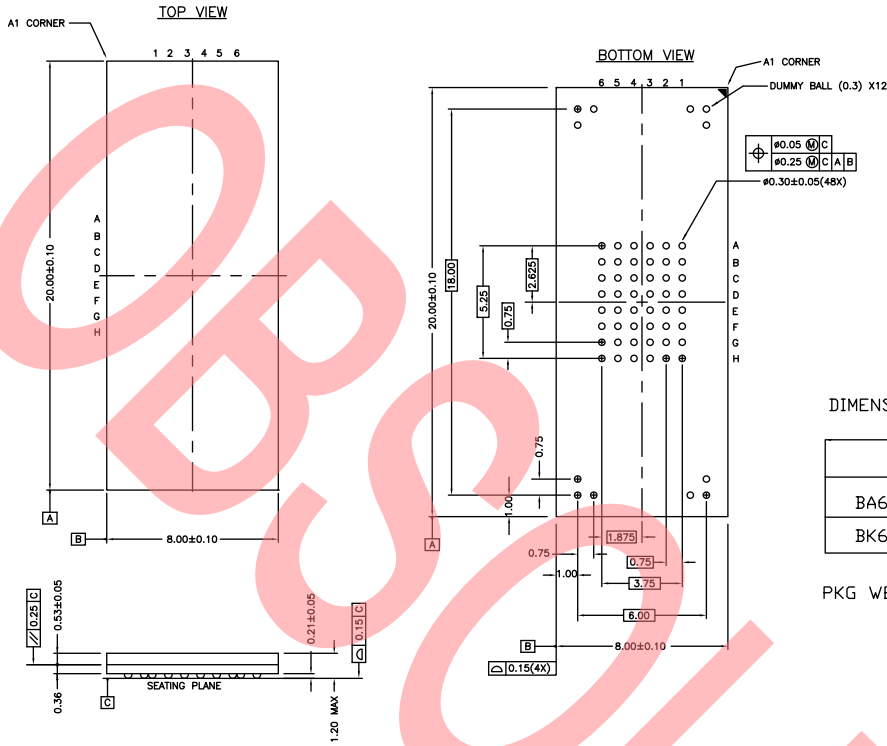

Acronyms

Acronym	Description
CMOS	Complementary Metal Oxide Semiconductor
FBGA	Fine-Pitch Ball Grid Array
I/O	Input/Output
\overline{OE}	Output Enable
SRAM	Static Random Access Memory
TSOP	Thin Small-Outline Package
TTL	Transistor-Transistor Logic
\overline{WE}	Write Enable

Document Conventions

Units of Measure

Symbol	Unit of Measure
°C	degree Celsius
MHz	megahertz
μA	microampere
mA	milliampere
mm	millimeter
ms	millisecond
mW	milliwatt
ns	nanosecond
Ω	ohm
%	percent
pF	picofarad
V	volt
W	watt

Document History Page

Document Title: CY7C1061AV33, 16-Mbit (1M × 16) Static RAM				
Document Number: 38-05256				
Revision	ECN	Submission Date	Orig. of Change	Description of Change
**	113725	03/28/02	NSL	New data sheet
*A	117058	07/31/02	DFP	Removed 15-ns bin
*B	117989	08/30/02	DFP	Added 8-ns bin Changed I _{cc} for 8, 10, 12 bins t _{power} changed from 1 μs to 1 ms. Load Cap Comment changed (for Tx line load) t _{SD} changed to 5.5 ns for the 10-ns bin Changed some 8-ns bin numbers (t _{HZ} , t _{DOE} , t _{DBE}) Removed hz<lz comments from data sheet
*C	120383	11/06/02	DFP	Final data sheet Added note 3 to “AC Test Loads and Waveforms” and note 7 to t _{pu} and t _{pd} Updated Input/Output Caps (for 48BGA only) to 8 pF/10 pF and for the 54-pin TSOP to 6/8 pF
*D	124439	2/25/03	MEG	Changed ISB1 from 100 mA to 70 mA Shaded FBGA production ordering information
*E	492137	See ECN	NXR	Corrected Block Diagram on page #1 Removed 8 ns speed bin Changed 48-Ball FBGA to 60-Ball FBGA in Pin Configuration Included Note #1 and 2 on page #2 Changed the description of I _{IX} from Input Load Current to Input Leakage Current in DC Electrical Characteristics table Updated the Ordering Information Table
*F	508117	See ECN	NXR	Updated FBGA Pin Configuration Updated Ordering Information table
*G	877322	See ECN	VKN	Updated Ordering Information table
*H	2897049	03/22/10	KAO	Removed inactive parts from the ordering information table. Updated package diagrams. Updated links in Sales, Solutions and Legal Information.
*I	3109147	12/13/2010	KAO	Added Ordering Code Definitions under Ordering Information .
*J	3160428	02/02/11	PRAS	Updated Ordering Information : Updated part numbers. Updated to new template.
*K	3222127	04/11/2011	PRAS	Added Acronyms and Units of Measure .
*L	4363272	04/28/2014	MEMJ	Updated Switching Waveforms : Added Note 20 and referred in Figure 8 . Updated Package Diagrams : spec 51-85160 – Changed revision from *A to *D. spec 51-85162 – Changed revision from *E to *F. Updated to new template. Completing Sunset Review.
*M	4578447	01/16/2015	MEMJ	Updated Functional Description : Added “For a complete list of related documentation, click here .” at the end. Updated Package Diagrams : spec 51-85160 – Changed revision from *D to *E.
*N	5738556	05/16/2017	VINI	Obsolete document. Completing Sunset Review.

Sales, Solutions, and Legal Information

Worldwide Sales and Design Support

Cypress maintains a worldwide network of offices, solution centers, manufacturer's representatives, and distributors. To find the office closest to you, visit us at [Cypress Locations](#).

Products

Automotive	cypress.com/go/automotive
Clocks & Buffers	cypress.com/go/clocks
Interface	cypress.com/go/interface
Lighting & Power Control	cypress.com/go/powerpsoc
Memory	cypress.com/go/memory
PSoC	cypress.com/go/psoc
Touch Sensing	cypress.com/go/touch
USB Controllers	cypress.com/go/USB
Wireless/RF	cypress.com/go/wireless

PSoC[®] Solutions

[psoc.cypress.com/solutions](#)
[PSoC 1](#) | [PSoC 3](#) | [PSoC 4](#) | [PSoC 5LP](#)

Cypress Developer Community

[Community](#) | [Forums](#) | [Blogs](#) | [Video](#) | [Training](#)

Technical Support

[cypress.com/go/support](#)

© Cypress Semiconductor Corporation, 2002-2017. The information contained herein is subject to change without notice. Cypress Semiconductor Corporation assumes no responsibility for the use of any circuitry other than circuitry embodied in a Cypress product. Nor does it convey or imply any license under patent or other rights. Cypress products are not warranted nor intended to be used for medical, life support, life saving, critical control or safety applications, unless pursuant to an express written agreement with Cypress. Furthermore, Cypress does not authorize its products for use as critical components in life-support systems where a malfunction or failure may reasonably be expected to result in significant injury to the user. The inclusion of Cypress products in life-support systems application implies that the manufacturer assumes all risk of such use and in doing so indemnifies Cypress against all charges.

Any Source Code (software and/or firmware) is owned by Cypress Semiconductor Corporation (Cypress) and is protected by and subject to worldwide patent protection (United States and foreign), United States copyright laws and international treaty provisions. Cypress hereby grants to licensee a personal, non-exclusive, non-transferable license to copy, use, modify, create derivative works of, and compile the Cypress Source Code and derivative works for the sole purpose of creating custom software and or firmware in support of licensee product to be used only in conjunction with a Cypress integrated circuit as specified in the applicable agreement. Any reproduction, modification, translation, compilation, or representation of this Source Code except as specified above is prohibited without the express written permission of Cypress.

Disclaimer: CYPRESS MAKES NO WARRANTY OF ANY KIND, EXPRESS OR IMPLIED, WITH REGARD TO THIS MATERIAL, INCLUDING, BUT NOT LIMITED TO, THE IMPLIED WARRANTIES OF MERCHANTABILITY AND FITNESS FOR A PARTICULAR PURPOSE. Cypress reserves the right to make changes without further notice to the materials described herein. Cypress does not assume any liability arising out of the application or use of any product or circuit described herein. Cypress does not authorize its products for use as critical components in life-support systems where a malfunction or failure may reasonably be expected to result in significant injury to the user. The inclusion of Cypress' product in a life-support systems application implies that the manufacturer assumes all risk of such use and in doing so indemnifies Cypress against all charges.

Use may be limited by and subject to the applicable Cypress software license agreement.