

# Features

# Regulated Converters

- 15W in 2" x 1" Package
- 2kVDC And 3kVDC Isolation Options
- 2:1 or 4:1 Input Voltage Range
- Continuous Short Circuit Protection (Power Limiting)
- Full SMD Internal Design
- Synchronous Rectification On 3.4V & 5.1V Outputs
- CTRL Pin Option

## Description

The REC15-xxxxS\_D/M -series offer single and dual regulated outputs in a 2"x1" package with 2kVDC or 3kVDC isolation options and are suitable for higher power industrial applications. Remote on/off control is standard. The converters can deliver 150% rated power for short periods of time to cope with applications with large capacitive loads or high start up currents. The outputs with 3A load current have raised output voltages to compensate for track losses as standard.

## Selection Guide

Part Number	Input Voltage Range [VDC]	Output Voltage [VDC]	Output Current [mA]	Efficiency typ. (1) [%]	max. Capacitive Load [µF]
REC15-xx3.4S	9-18, 18-36, 36-75	3.4	3000	84-85	3300
REC15-xx5.1S	9-18, 18-36, 36-75	5.1	3000	86-87	3300
REC15-xx12S	9-18, 18-36, 36-75	12	1250	85-86	3300
REC15-xx15S	9-18, 18-36, 36-75	15	1000	85-86	3300
REC15-xx05D	9-18, 18-36, 36-75	±5	±1500	82-83	±1500
REC15-xx12D	9-18, 18-36, 36-75	±12	±625	85-86	±1000
REC15-xx15D	9-18, 18-36, 36-75	±15	±500	85-86	±1000
REC15-xx3.4SZ	9-36, 18-75	3.4	3000	84-85	3300
REC15-xx5.1SZ	9-36, 18-75	5.1	3000	87	3300
REC15-xx12SZ	9-36, 18-75	12	1250	86	3300
REC15-xx15SZ	9-36, 18-75	15	1000	86	3300
REC15-xx05DZ	9-36, 18-75	±5	±1500	83	±1500
REC15-xx12DZ	9-36, 18-75	±12	±625	86	±1000
REC15-xx15DZ	9-36, 18-75	±15	±500	86	±1000

### Notes:

Note1: Efficiency is tested at nominal input and full load at +25°C ambient.

## Model Numbering

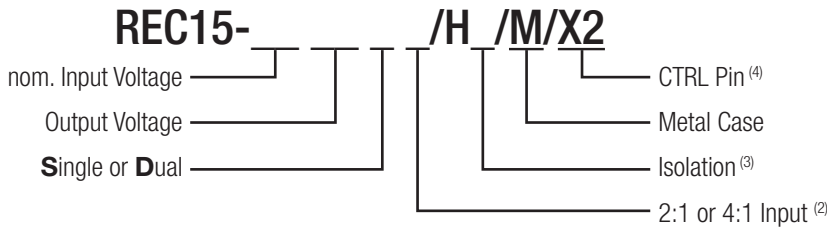

### Notes:

Note2: add „Z“ for 4:1 Input Voltage (24= 9-36VDC or 48= 18-75VDC)

Note3: „/H2“ = 2kVDC isolation

„/H3“ = 3kVDC isolation

Note4: without suffix, standard Pinning with CTRL Pin  
with suffix „/X2“, without CTRL Pin

### Ordering Examples:

REC15-125.1S/H3/M	9-18Vin	5.1Vout	Single output	2:1 input	3kVDC isolation	with CTRL Pin
REC15-2412DZ/H2/M/X2	9-36Vin	±12Vout	Dual output	4:1 input	2kVDC isolation	without CTRL Pin
REC15-2412S/H3/M	18-36Vin	12Vout	Single Output	2:1 input	3kVDC isolation	with CTRL Pin
REC15-4815DZ/H2/M	18-75Vin	±15Vout	Dual Output	4:1 input	2kVDC isolation	with CTRL Pin
REC15-2405SZ/H2/M/X2	18-36	24Vout	Single Output	2:1 input	2kVDC isolation	without CTRL Pin

**RECOM**  
DC/DC Converter

**REC15-S\_D(Z)/M**

15 Watt  
2" x 1"



**Metal Case**  
**Single and Dual**



IEC60950-1 + AM2 Certified  
EN60950-1 + AM2 Certified  
UL60950-1 Certified  
IEC/EN60601-1 Certified  
CB Report

Specifications (measured @  $t_a = 25^\circ\text{C}$ , nominal input voltage, full load and after warm up unless otherwise specified)

BASIC CHARACTERISTICS				
Parameter	Condition	Min.	Typ.	Max.
Internal Input Filter				Pi Network
Input Voltage Range	2:1 Input Voltage = 12VDC 24VDC 48VDC	9VDC 18VDC 36VDC		18VDC 36VDC 75VDC
	4:1 Input Voltage = 24VDC 48VDC	9VDC 18VDC		36VDC 75VDC
Input Surge Voltage	100ms max. nom. Input Voltage			36VDC 50VDC 100VDC
Under Voltage Lockout (UVLO)	nom. Vin= 12VDC (2:1 and 4:1 Input Types)	DC-DC ON DC-DC OFF		8.3VDC 7.9VDC
	nom. Vin= 24VDC (2:1 and 4:1 Input Types)	DC-DC ON DC-DC OFF		17.4VDC 16.7VDC
	nom. Vin= 48VDC	DC-DC ON DC-DC OFF		35.7VDC 34.3VDC
Input Current	2:1 Input Voltage = 9-18VDC 18-36VDC 36-75VDC		2A 1A 0.5A	
	4:1 Input Voltage = 9-36VDC 18-75VDC		2A 1A	
Quiescent Current				20mA
Minimum Load			0%	
Start-up time			25ms	
Rise Time			200 $\mu$ s	
Hold-up Time			200 $\mu$ s	
ON/OFF CTRL	DC-DC ON DC-DC OFF			Open or $3.5\text{V} < V_r < 12\text{V}$ $0\text{V} < V_r < 1.2\text{V}$
Internal Operating Frequency			300kHz	
Output Ripple and Noise <sup>(4)</sup>	20MHz BW			100mVp-p

**Notes:**

Note4: Measurements are made with a 100nF MLCC across output. (low ESR)

**Efficiency vs. Load**

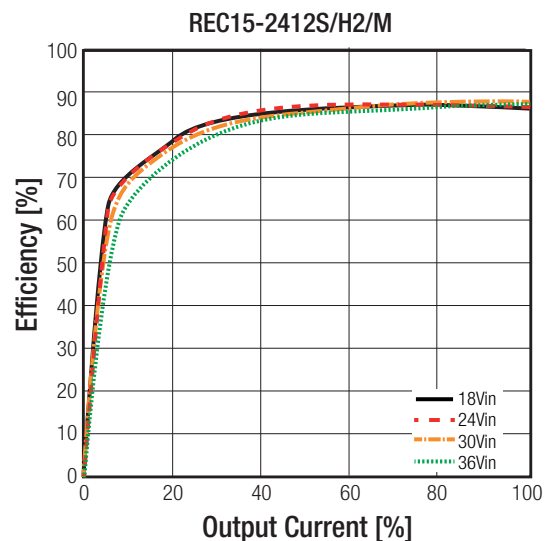
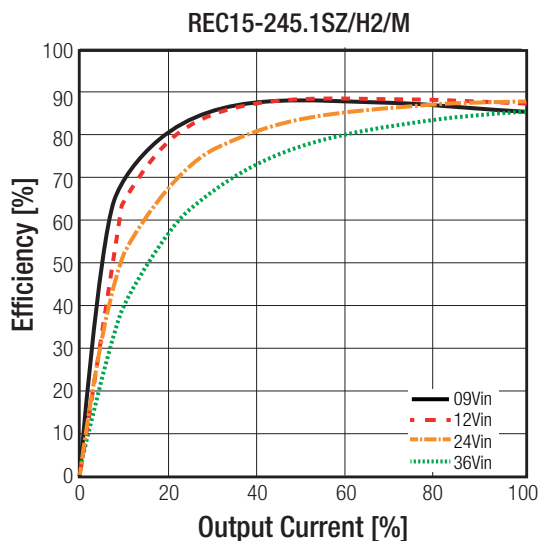

continued on next page

**Specifications** (measured @  $t_a = 25^\circ\text{C}$ , nominal input voltage, full load and after warm up unless otherwise specified)

Efficiency vs. Load

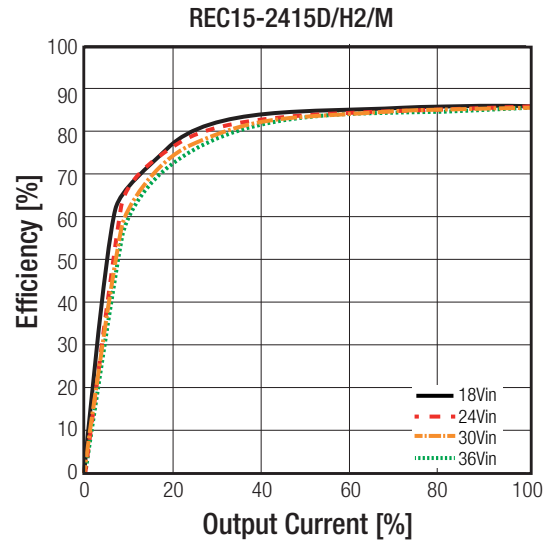
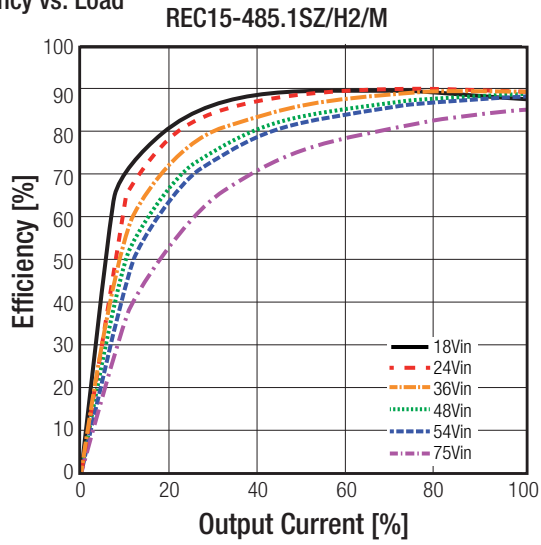

**REGULATIONS**

Parameter	Condition		Value
Output Accuracy	3.4Vout		±1.2% max.
	all other		±1.0% max.
Line Regulation			±0.3% max.
Load Regulation	25% to 100% load	Single	±0.5% max.
		Dual	±1.2% max.
Cross Regulation	dual output only	25% to 100% load	±5.0% max.

Accuracy vs. Load

(@ min Vin to max. Vin)

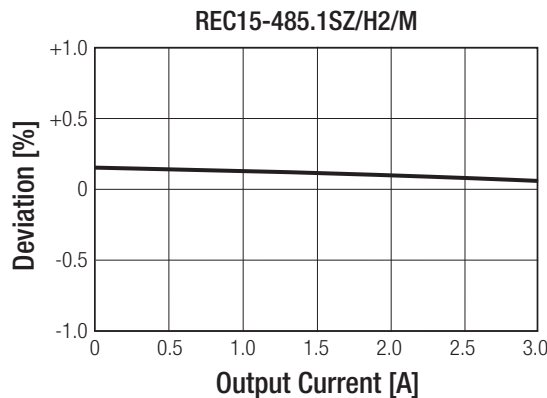
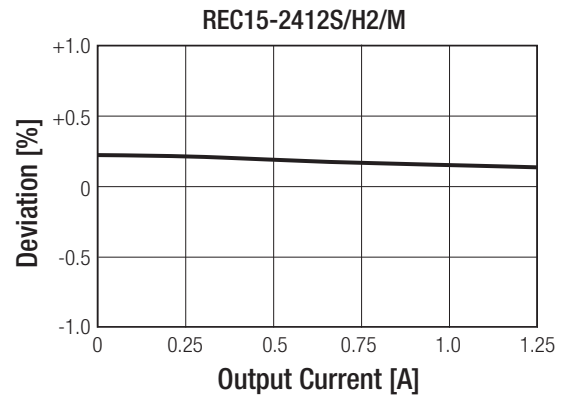
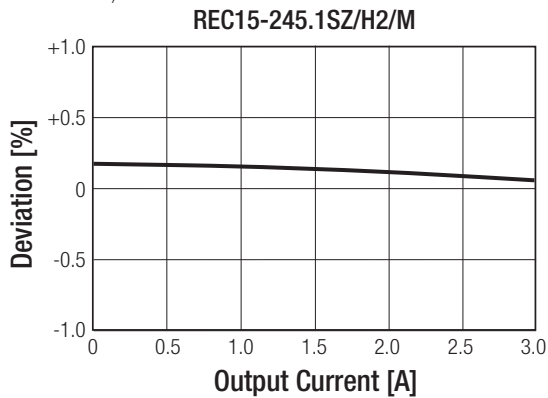

continued on next page

**Specifications** (measured @  $t_a=25^\circ\text{C}$ , nominal input voltage, full load and after warm up unless otherwise specified)

**Accuracy vs. Load**  
(@ min  $V_{in}$  to max.  $V_{in}$ )

REC15-2415DZ/H2/M

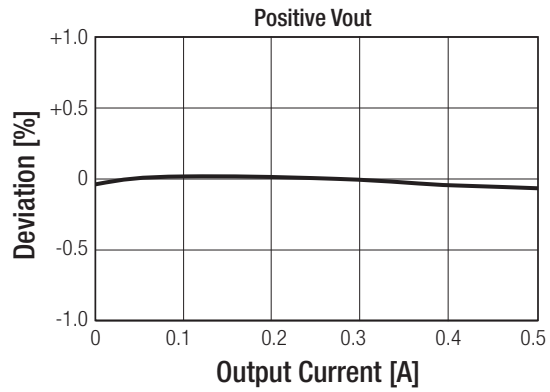
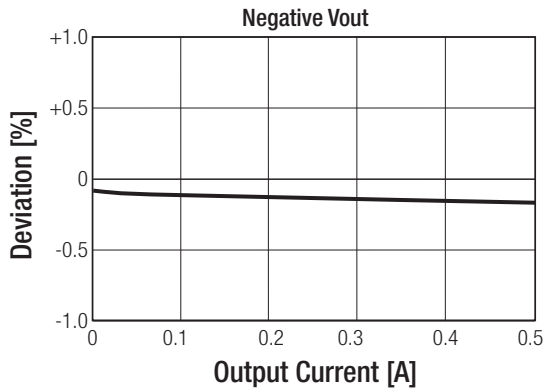

**PROTECTIONS**

Parameter	Type	Value	
Short Circuit Protection (SCP)	below 100mΩ	continuous, auto recovery	
Over Load Protection (OLP)		150% typ., Hiccup mode	
Isolation Voltage <sup>(7)</sup>	/H2 versions	tested for 1 second	2kVDC
		rated for 1 minute	1kVAC
	/H3 versions	tested for 1 second	3kVDC
		rated for 1 minute	1.5kVAC
Isolation Resistance		1GΩ min.	
Isolation Capacitance		1200pF max.	
Insulation Grade		basic	
Means of Protection		none	
Leakage Current		2μA typ.	
Internal and External	Clearance	≥ 3.4mm	
	Creepage	≥ 3.4mm	

**Notes:**

Note7: For repeat Hi-Pot testing, reduce the time and/or the test voltage.

Note8: An input fuse is required if the mains supply is not over-current protected. Recommended fuse: T4A slow blow type

**ENVIRONMENTAL**

Parameter	Condition		Value
Operating Temperature Range	with derating (see graph)	2:1 Input	-40°C to +100°C
		4:1 Input	-40°C to +90°C
Maximum Case Temperature			+100°C
Thermal Impedance	0.1 m/s (natural convection)		12°C/W
Temperature Coefficient			±0.05% max.
Temperature Coefficient			±0.05% max.
Operating Altitude			2000m max.
Operating Humidity	non-condensing		95% RH max.
Pollution Degree			PD2
Vibration			10-55Hz, 2G, 30min along X,Y and Z
MTBF	according to MIL-HDBK-217F, G.B.	+25°C	700 x 10 <sup>3</sup> hours
		+71°C	150 x 10 <sup>3</sup> hours

continued on next page

**Specifications** (measured @  $t_a = 25^\circ\text{C}$ , nominal input voltage, full load and after warm up unless otherwise specified)

### Derating Graph

(@ Chamber and natural convection 0.1m/s)

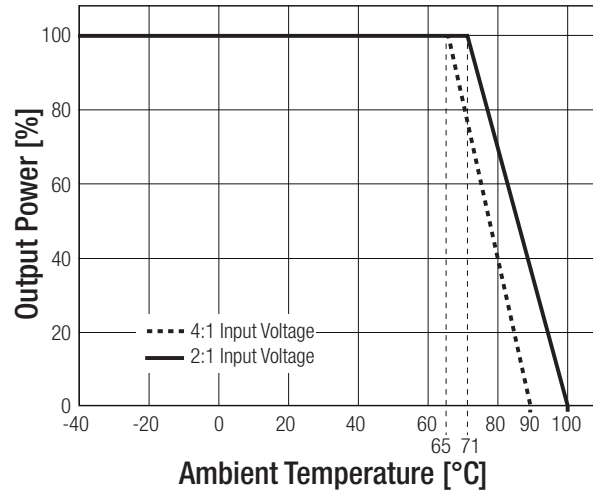

### SAFETY AND CERTIFICATIONS

Certificate Type (Safety)	Report / File Number	Standard
Information Technology Equipment, General Requirements for Safety (LVD)	E224736-A19	UL60950-1, 2nd Edition, 2007 CAN/CSA-C22.2 No. 60950-1-03, 2nd Edition, 2007
Information Technology Equipment, General Requirements for Safety (CB Scheme)	1310058-1	IEC60950-1:2005, 2nd Edition + 2009 EN60950-1, 2nd Edition, 2011
Information Technology Equipment, General Requirements for Safety (LVD)	LVD1605077-01	IEC60950-1:2005, 2nd Edition + A2:2013 EN60950-1:2006 + A2:2013
Medical electrical equipment Part 1: General requirements for basic safety and essential performance	MDD12060585	IEC60601-1, 3rd Edition, 2007 EN60601-1, 2006
Risk Management	RM12060585	ISO14971:2007
RoHs2		RoHS 6/6, 2011/65/EU + AM-2015/863

EMC Compliance	Condition	Standard / Criterion
Information technology equipment - Radio disturbance characteristics - Limits and methods of measurement	with external filter	EN55022, Class B

### EMC Filtering Suggestions for EN55022 Class B

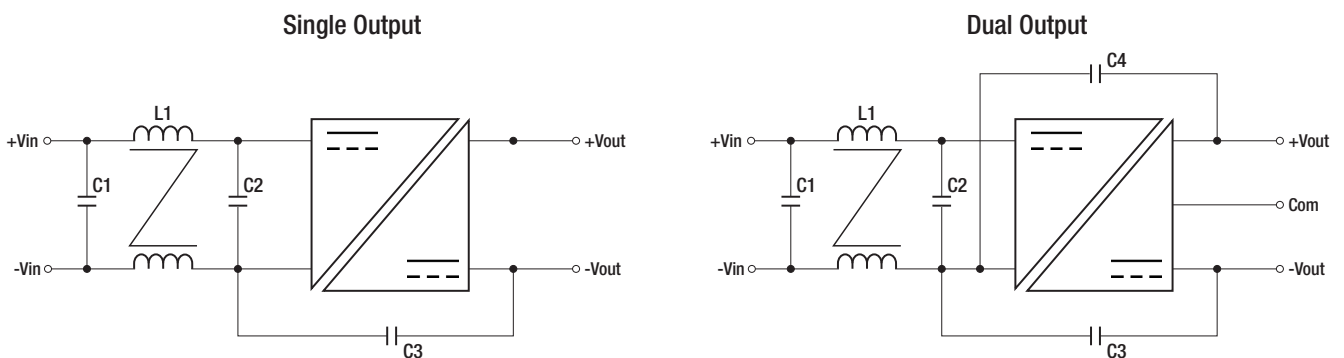

according to EN55022 Class B					
Vin	C1	C2	C3	C4	L1
12VDC	10 $\mu\text{F}$		3.3nF		CMC, 1200 $\mu\text{H}$ WE 7446723001
24VDC	4.7 $\mu\text{F}$				
48VDC	2.2 $\mu\text{F}$				

**Specifications** (measured @  $t_a = 25^\circ\text{C}$ , nominal input voltage, full load and after warm up unless otherwise specified)

### DIMENSION and PHYSICAL CHARACTERISTICS

Parameter	Type	Value
Material	Case	nickel plated metal, (UL94 V-2)
	PCB	FR4 (UL94-V-1)
	Potting	epoxy (UL94 V-0)
Package Dimension (LxWxH)		50.8 x 25.4 x 10.2mm
Package Weight		27g typ.

### Dimension Drawing DIP24 metal case (mm)

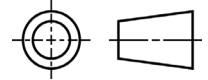

### Pin Connection

Pin #	Single	Dual	Single /X2	Dual /X2
1	+Vin	+Vin	+Vin	+Vin
2	-Vin	-Vin	-Vin	-Vin
3	+Vout	+Vout	+Vout	+Vout
4	No Pin	Com	No Pin	Com
5	-Vout	-Vout	-Vout	-Vout
6	CTRL	CTRL	No Pin	No Pin

Tolerance: xx.x= ±0.5mm  
xx.xx= ±0.35mm

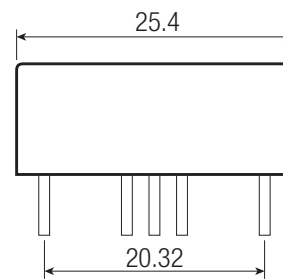
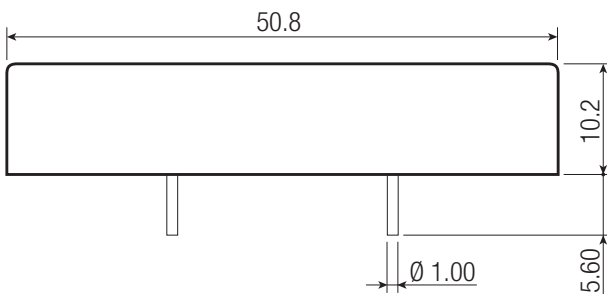

### Recommended Footprint Details

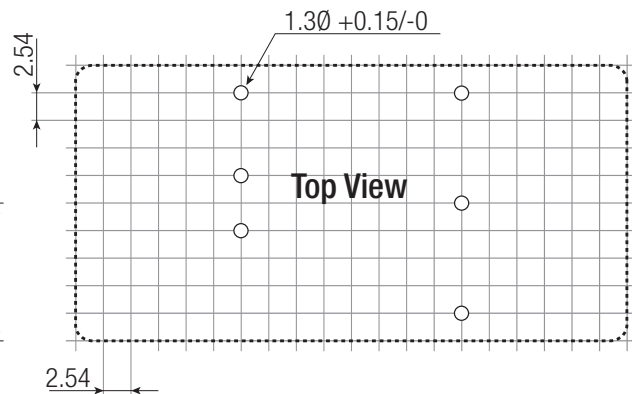
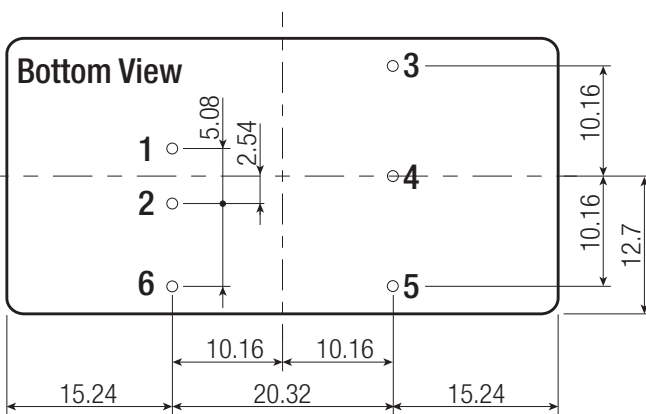

### PACKAGING INFORMATION

Packaging Dimension (LxWxH)	tube	276.0 x 54.5 x 21.0mm
Packaging Quantity		10pcs
Storage Temperature Range		-55°C to +105°C
Storage Humidity		95% RH max.

The product information and specifications may be subject to changes even without prior written notice. The product has been designed for various applications; its suitability lies in the responsibility of each customer. The products are not authorized for use in safety-critical applications without RECOM's explicit written consent. A safety-critical application is an application where a failure may reasonably be expected to endanger or cause loss of life, inflict bodily harm or damage property. The applicant shall indemnify and hold harmless RECOM, its affiliated companies and its representatives against any damage claims in connection with the unauthorized use of RECOM products in such safety-critical applications.

# Mouser Electronics

Authorized Distributor

Click to View Pricing, Inventory, Delivery & Lifecycle Information:

## RECOM:

[REC15-485.1SZ/H3/M](#) [REC15-123.4S/H3/M](#) [REC15-1212S/H2/M](#) [REC15-2415SZ/H3/M](#) [REC15-2412S/H2/M](#)  
[REC15-243.4S/H2/M](#) [REC15-4812S/H2/M](#) [REC15-4815SZ/H3/M](#) [REC15-485.1S/H2/M](#) [REC15-243.4SZ/H2/M](#)  
[REC15-2405DZ/H2/M](#) [REC15-4812SZ/H3/M](#) [REC15-245.1S/H3/M](#) [REC15-2405DZ/H3/M](#) [REC15-485.1S/H3/M](#)  
[REC15-483.4S/H2/M](#) [REC15-2405D/H3/M](#) [REC15-243.4S/H3/M](#) [REC15-2415S/H2/M](#) [REC15-1215S/H3/M](#) [REC15-](#)  
[2415S/H3/M](#) [REC15-2412D/H2/M](#) [REC15-4815S/H3/M](#) [REC15-4805D/H2/M](#) [REC15-4815D/H3/M](#) [REC15-](#)  
[4812D/H2/M](#) [REC15-2415DZ/H3/M](#) [REC15-4812S/H3/M](#) [REC15-2412S/H3/M](#) [REC15-4812D/H3/M](#) [REC15-](#)  
[2412D/H3/M](#) [REC15-2412SZ/H2/M](#) [REC15-483.4SZ/H3/M](#) [REC15-2415SZ/H2/M](#) [REC15-1205D/H2/M](#) [REC15-](#)  
[2405D/H2/M](#) [REC15-1215D/H2/M](#) [REC15-123.4S/H2/M](#) [REC15-485.1SZ/H2/M](#) [REC15-2415D/H3/M](#) [REC15-](#)  
[4815S/H2/M](#) [REC15-245.1SZ/H2/M](#) [REC15-1215D/H3/M](#) [REC15-1205D/H3/M](#) [REC15-243.4SZ/H3/M](#) [REC15-](#)  
[4812DZ/H2/M](#) [REC15-2412DZ/H2/M](#) [REC15-2412DZ/H3/M](#) [REC15-4812SZ/H2/M](#) [REC15-1212D/H3/M](#) [REC15-](#)  
[125.1S/H3/M](#) [REC15-1212S/H3/M](#) [REC15-4805DZ/H3/M](#) [REC15-1215S/H2/M](#) [REC15-4805D/H3/M](#) [REC15-](#)  
[4815DZ/H2/M](#) [REC15-4812DZ/H3/M](#) [REC15-245.1SZ/H3/M](#) [REC15-4815SZ/H2/M](#) [REC15-2412SZ/H3/M](#) [REC15-](#)  
[4805DZ/H2/M](#) [REC15-125.1S/H2/M](#) [REC15-4815D/H2/M](#) [REC15-2415DZ/H2/M](#) [REC15-483.4SZ/H2/M](#) [REC15-](#)  
[4815DZ/H3/M](#) [REC15-1212D/H2/M](#) [REC15-483.4S/H3/M](#) [REC15-2415D/H2/M](#) [REC15-245.1S/H2/M](#)